

ТИПОВЫЕ КОНСТРУКЦИИ, ИЗДЕЛИЯ И УЗЛЫ ЗДАНИЙ И СООРУЖЕНИЙ

СЕРИЯ 1.020.1-4

КОНСТРУКЦИИ РАМНОГО КАРКАСА МЕЖВИДОВОГО ПРИМЕНЕНИЯ
ДЛЯ МНОГОЭТАЖНЫХ ОБЩЕСТВЕННЫХ ЗДАНИЙ, ПРОИЗВОДСТВЕННЫХ
И ВСПОМОГАТЕЛЬНЫХ ЗДАНИЙ ПРОМЫШЛЕННЫХ ПРЕДПРИЯТИЙ

выпуск 0-9

УКАЗАНИЯ ПО ПОДБОРУ ЭЛЕМЕНТОВ КАРКАСА
(Вариант армирования изделий сталью классов Ат-IVС и Врп-I).

часть 2

стр.112-239

Книга 2

стр.(176-239)

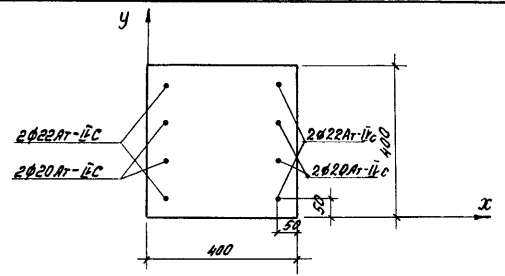
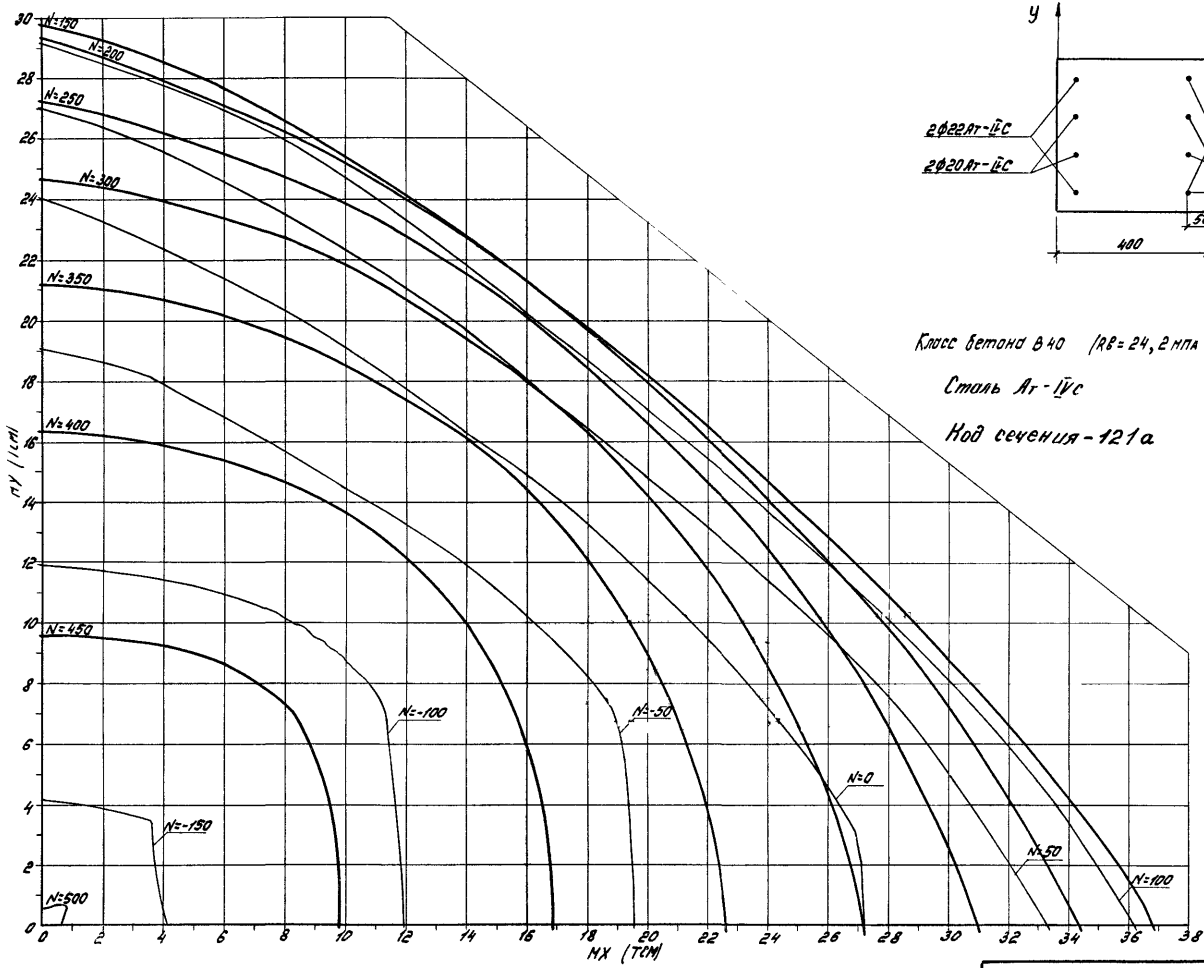

Класс бетона В40 ($R_b = 24$, 2 МПа при учёте $\gamma_{b2} = 1,10$)
 Сталь АТ-ІІС
 Нод сечения - 121а

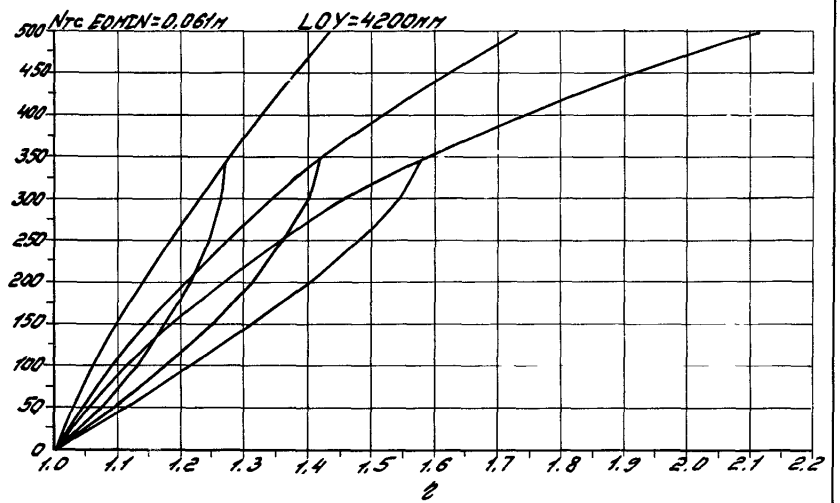
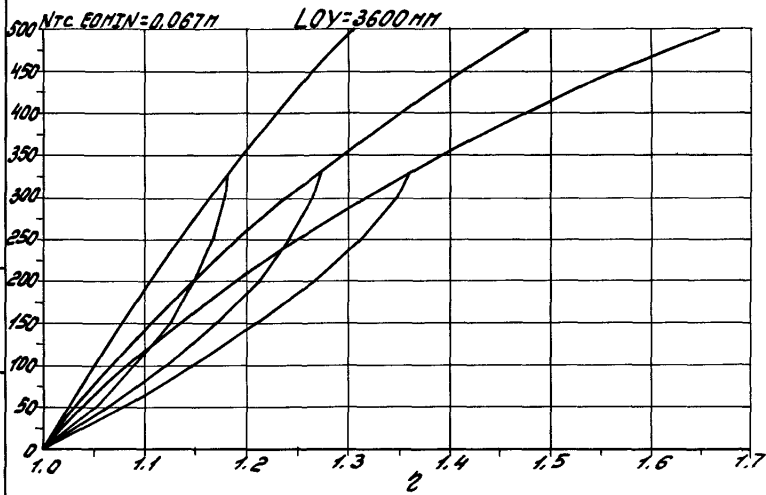
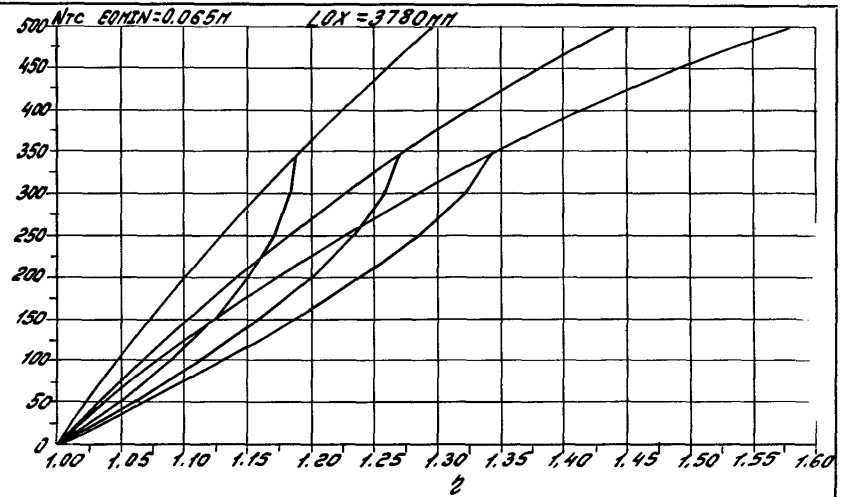
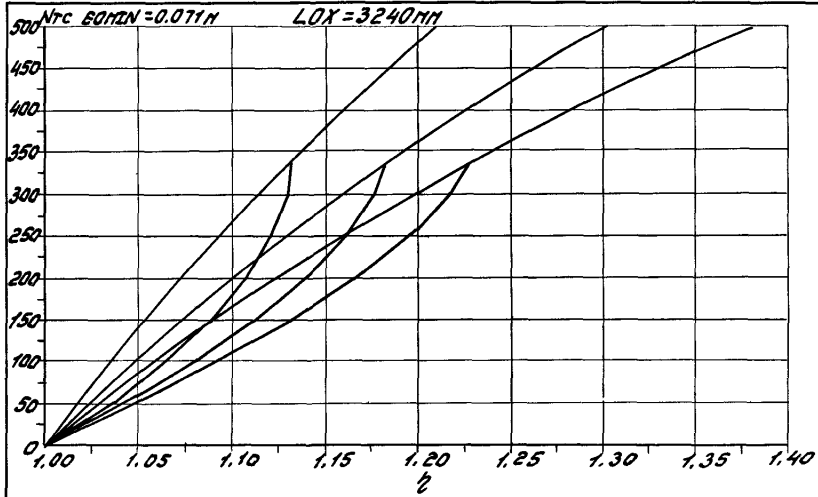

Див. Авиация. Подписано в штаб 18.30.00. 0068

1.020.1-4 0-9 002 Лист 162

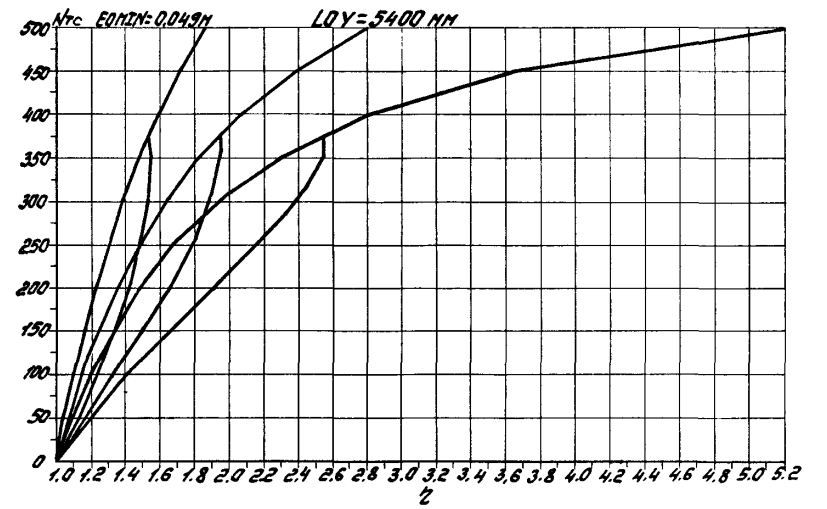
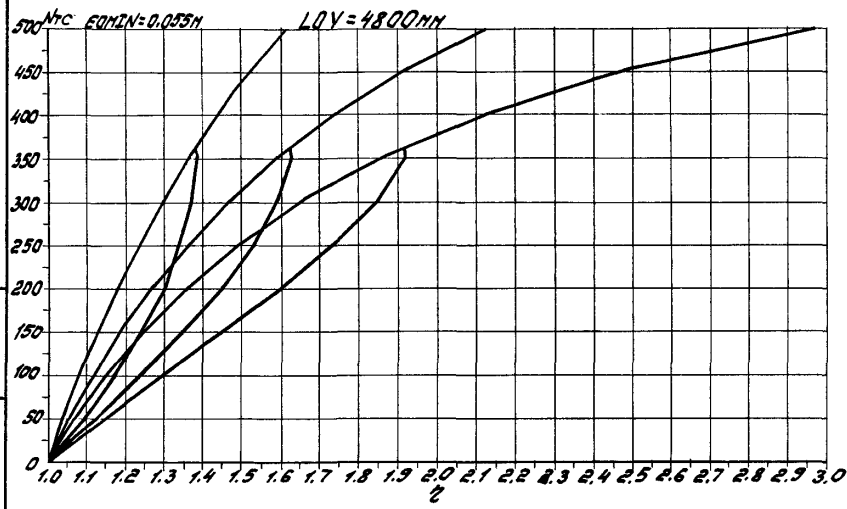
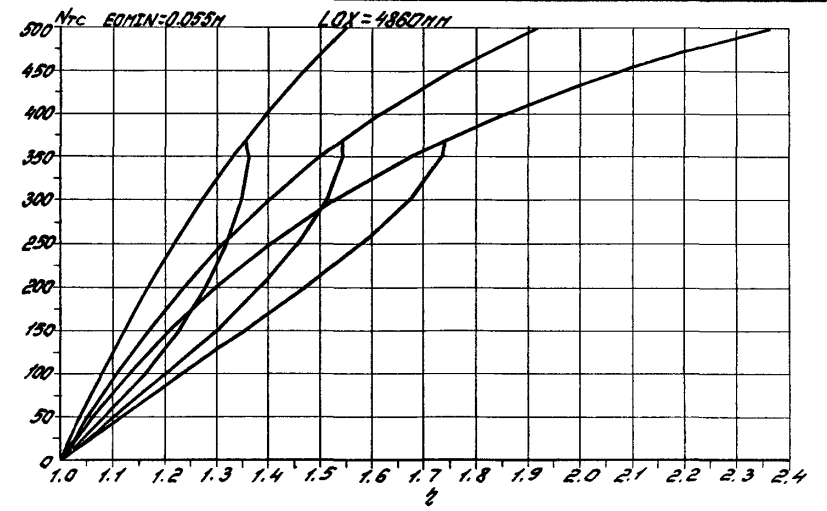
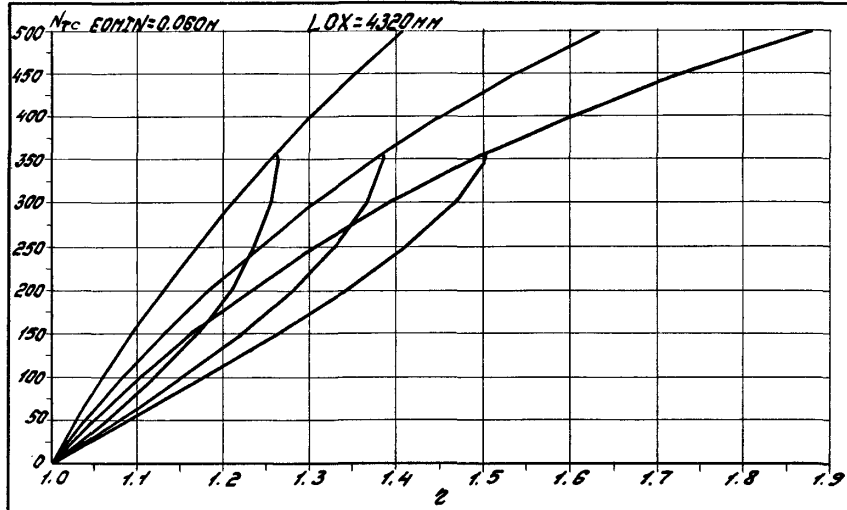

Информация по файлам в формате MSon. v.057

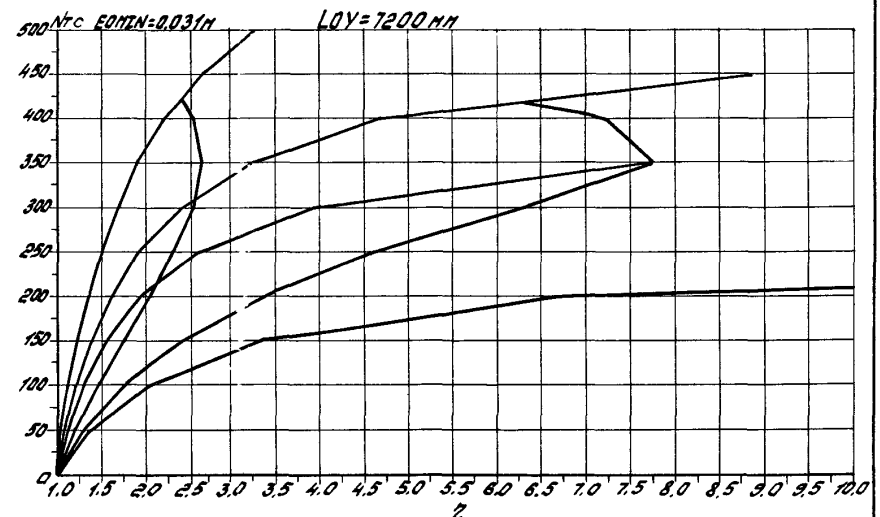
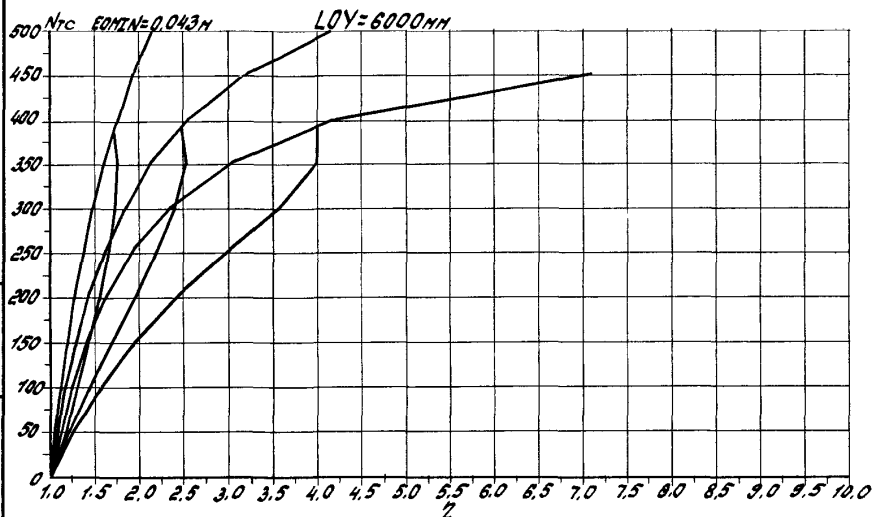
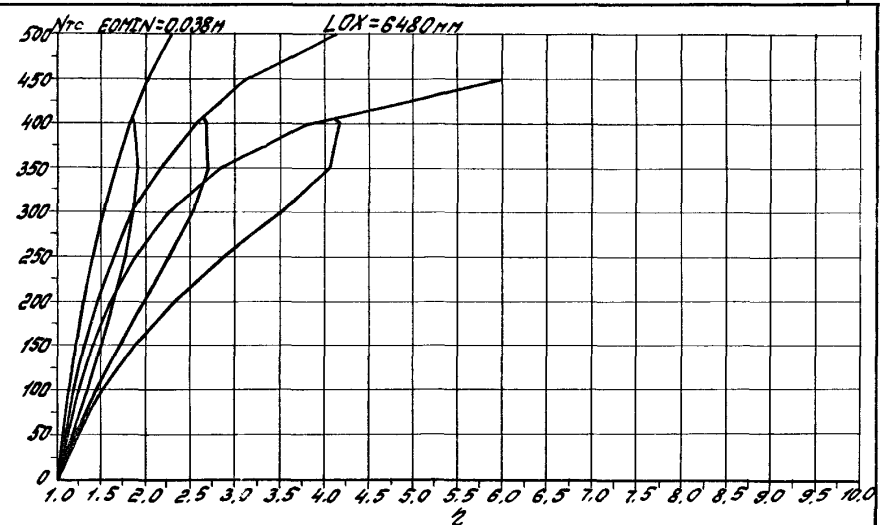
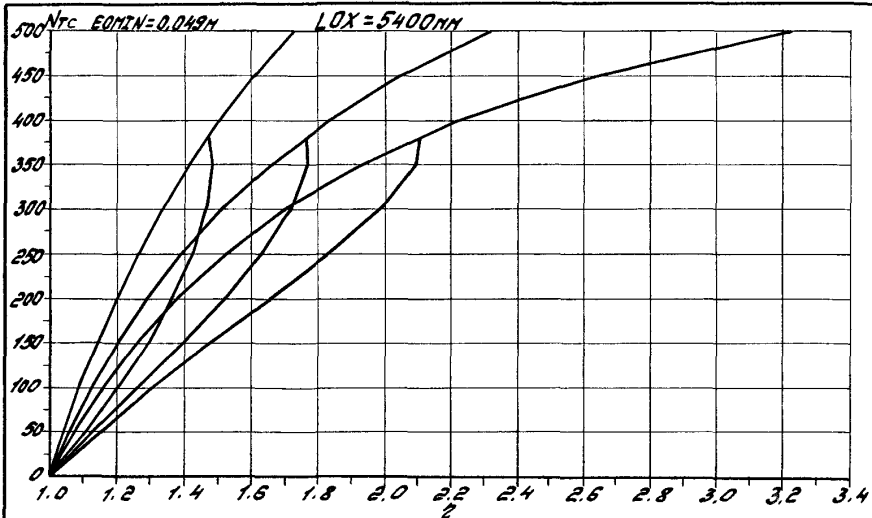

Уч. Архив. Проект 1.020.1-4 0-9 002

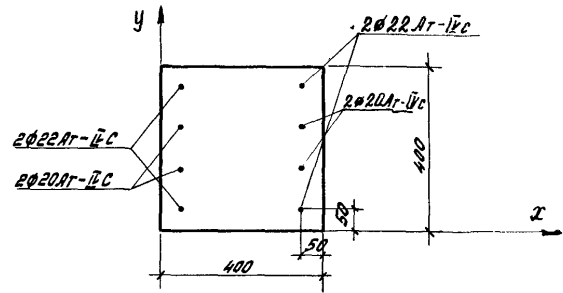
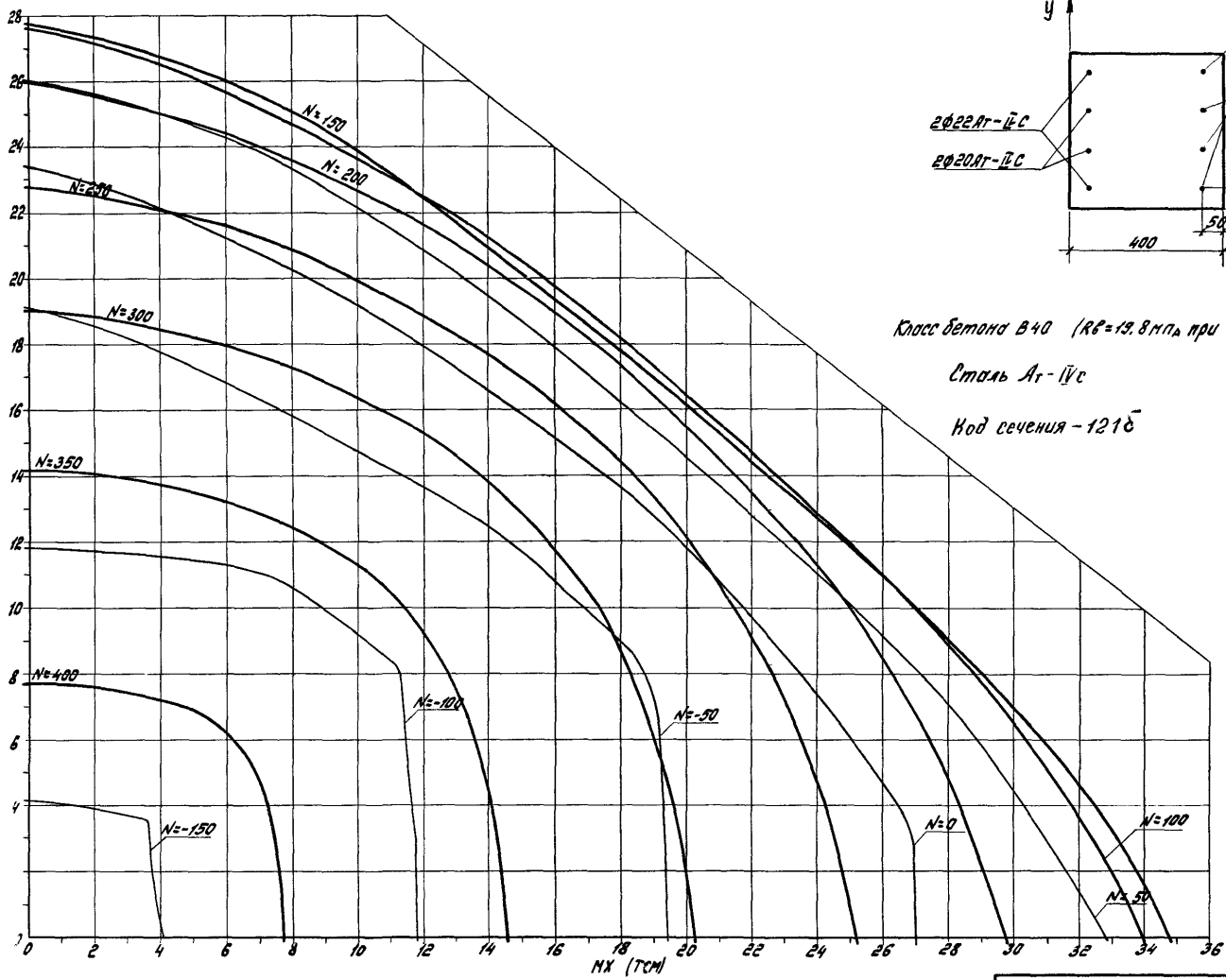

Класс бетона В40 ($R_b = 19.8 \text{ МПа}$ при учете $\gamma_{ce} = 0.90$)
 Сталь Ат-IVс
 Код сечения - 1216

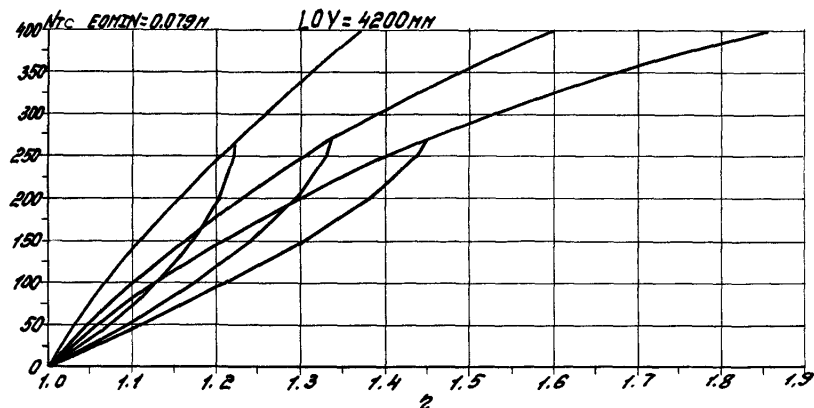
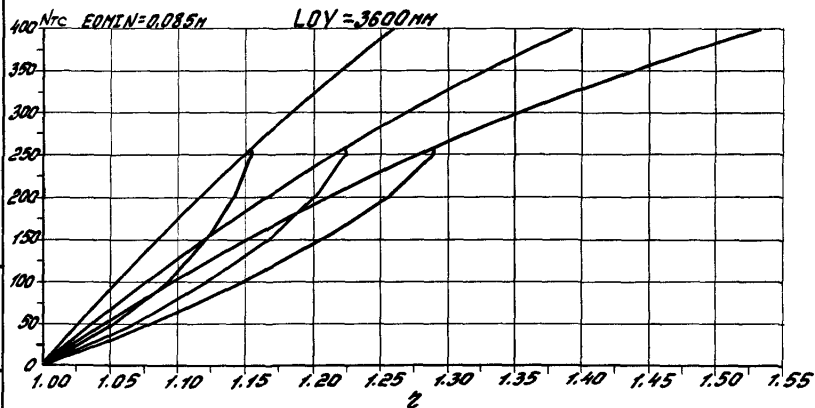
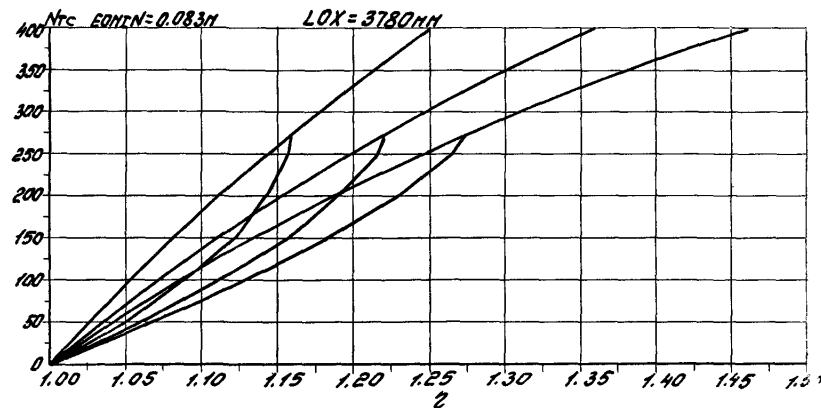
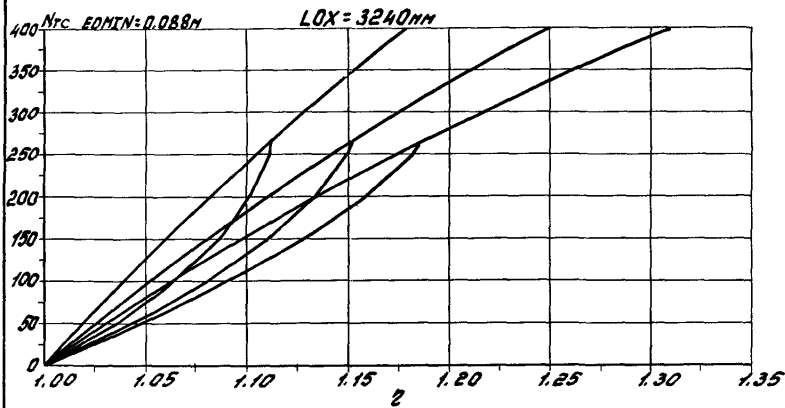

1.020.1-4 0-9 002

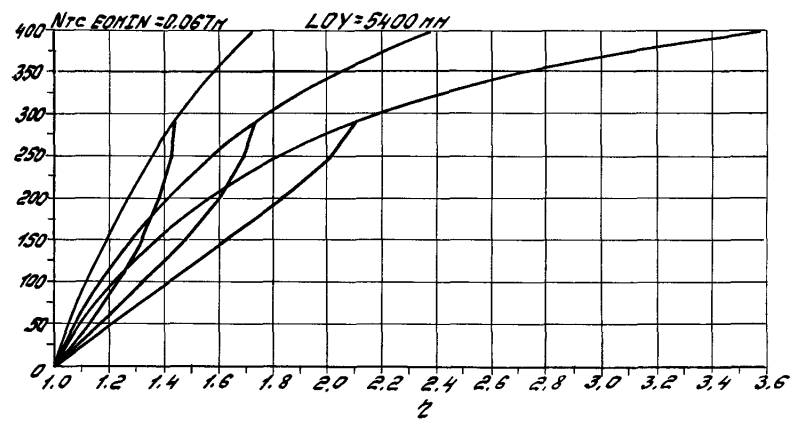
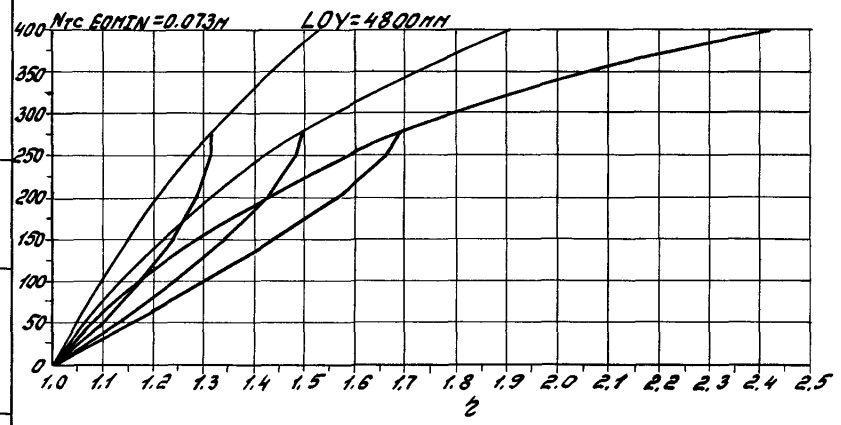
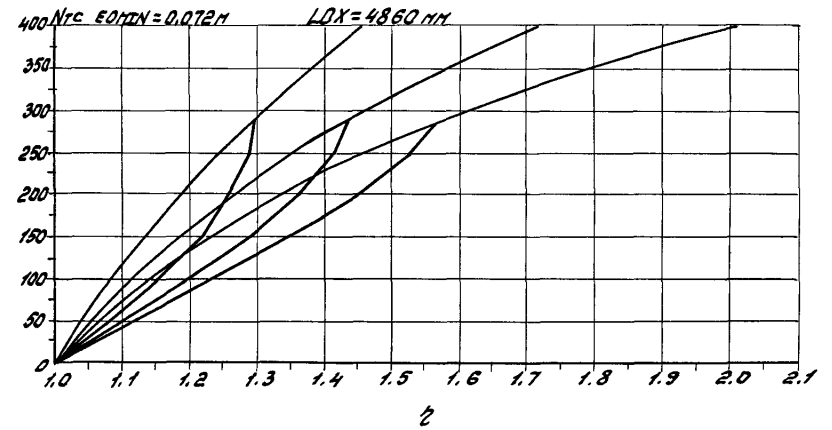
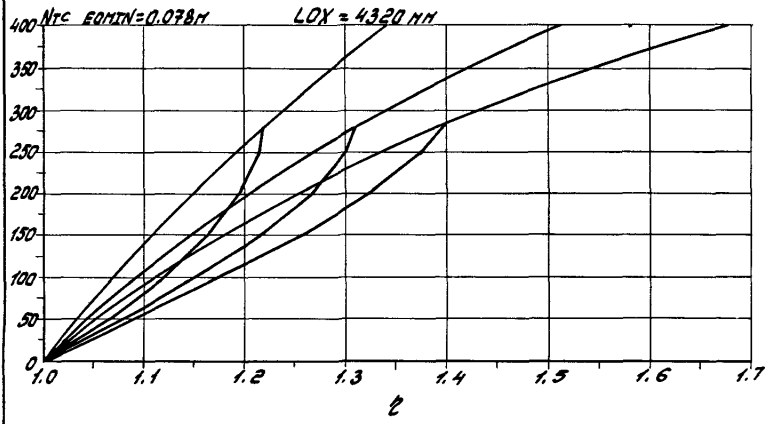

Vertical text label on the left margin, possibly a page or document identifier.

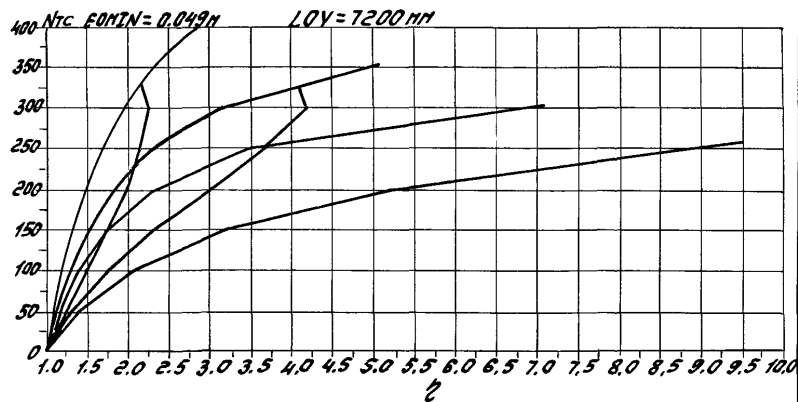
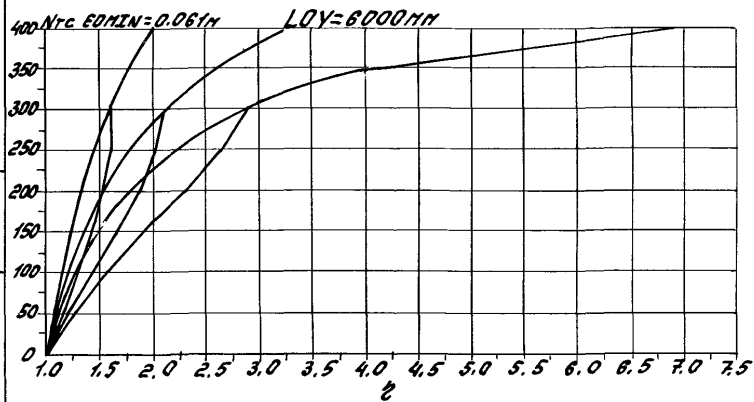
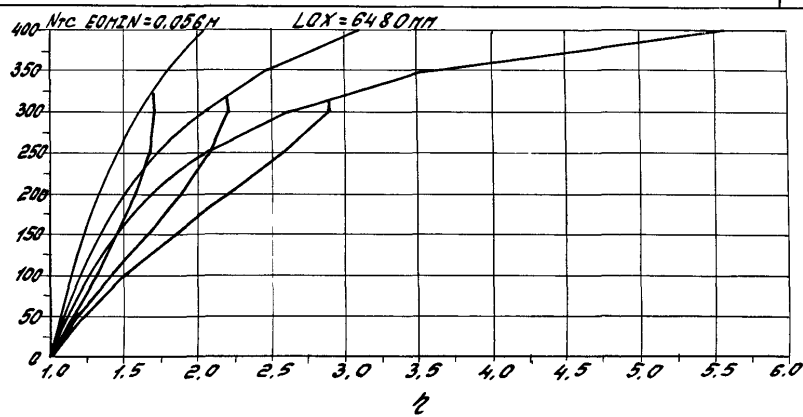
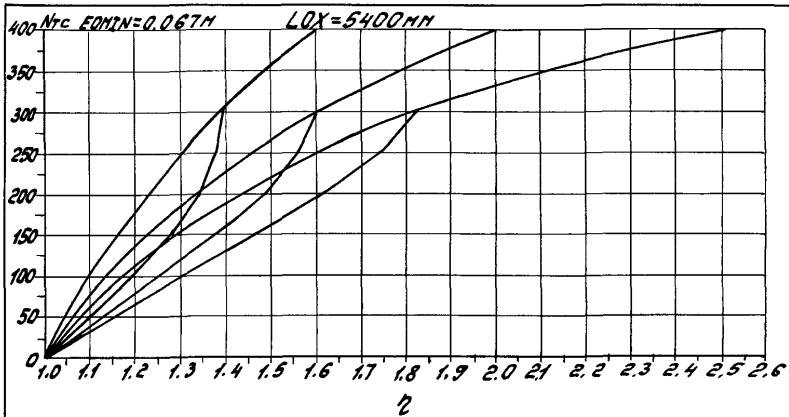

Шаб. №1000. Подпись и дата ВЗНМ-ШТБМ

1.020.1-4 0-9 002 Лист
168

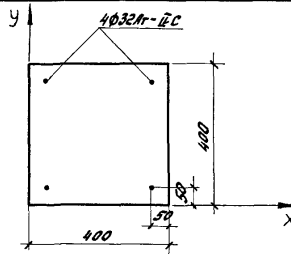
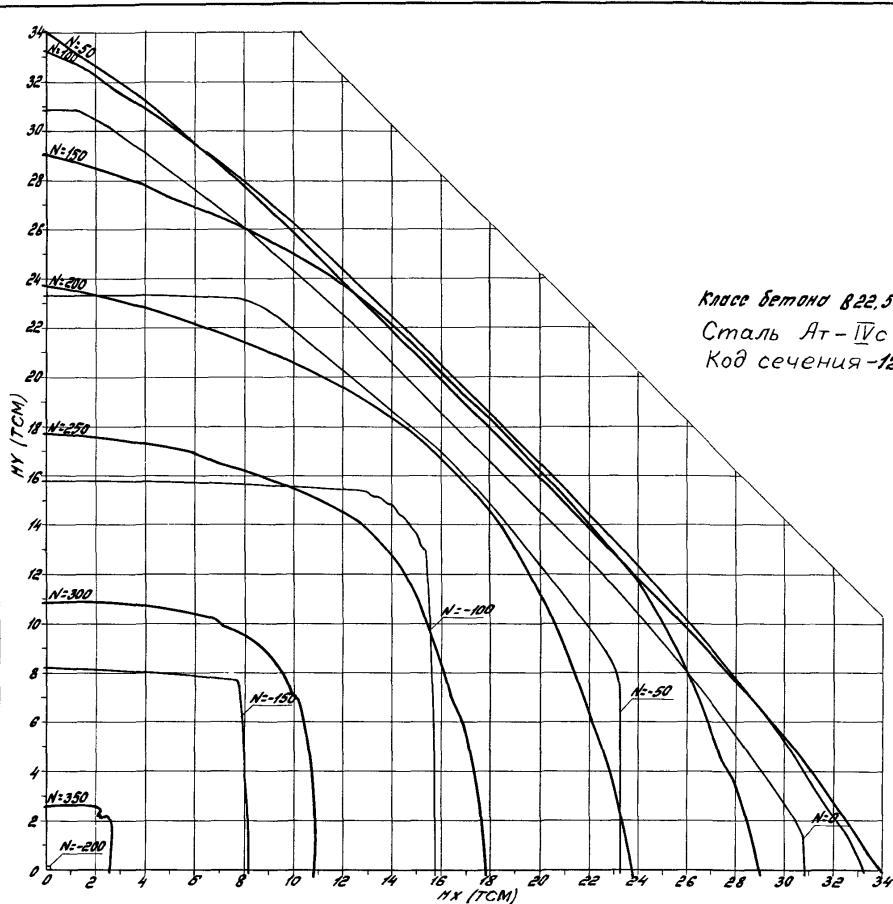

Класс бетона В22,5 ($R_b = 14.3 \text{ МПа}$, при учёте $\gamma_{b2} = 1.10$)
 Сталь Ат-IVс
 Код сечения-122а

1.0201-4 0-9 002

1/22

169

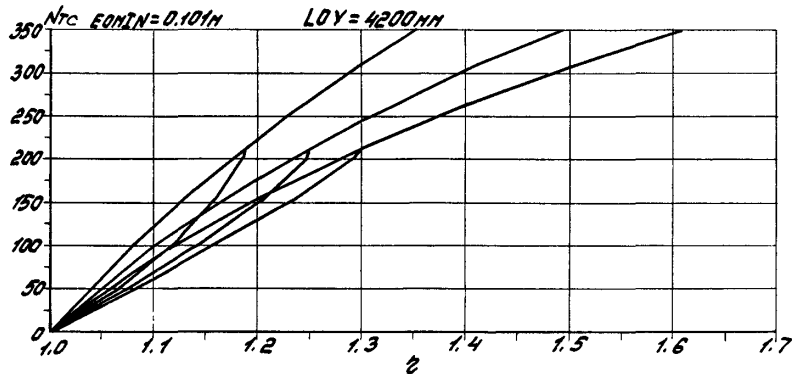
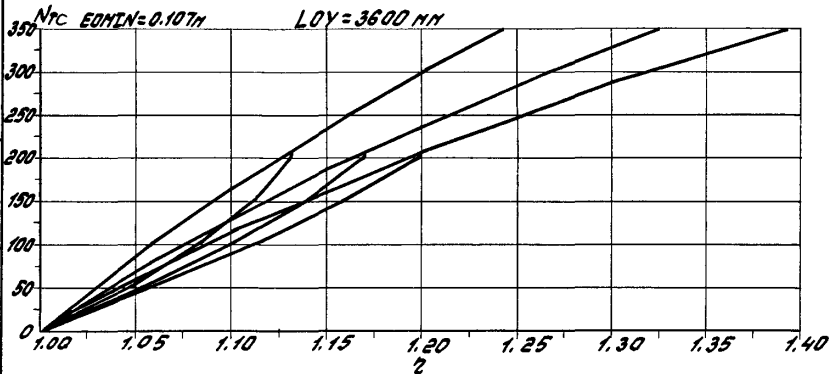
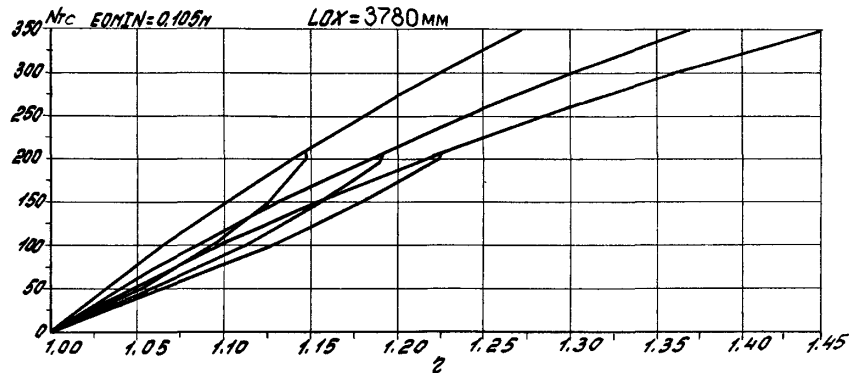
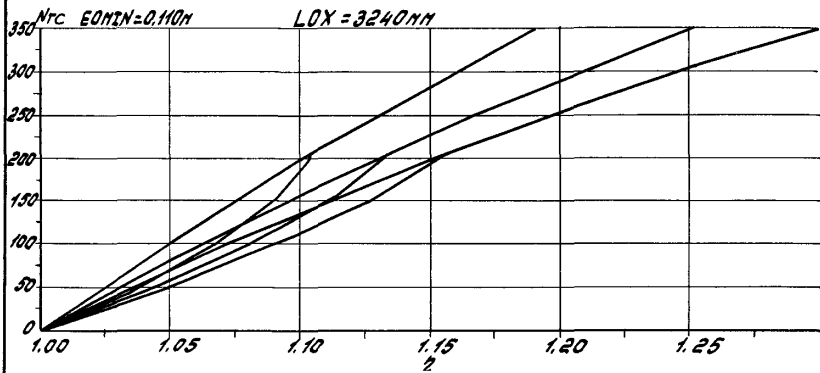

1/16.12.1974. 1/16.12.1974. 1/16.12.1974.

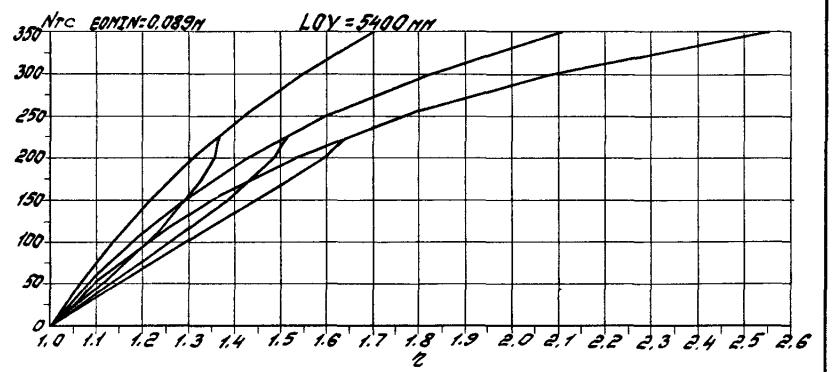
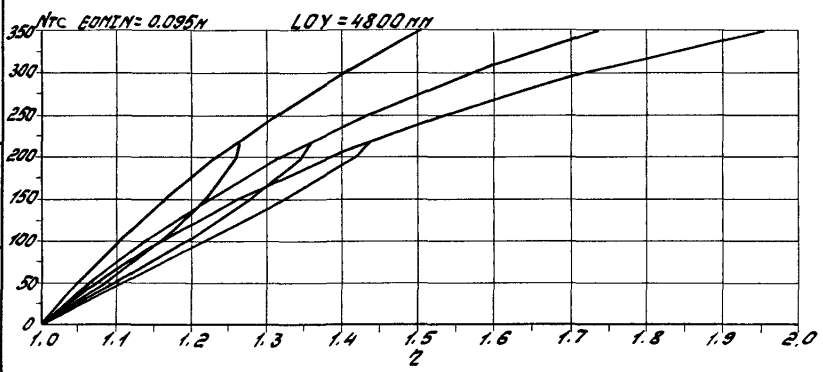
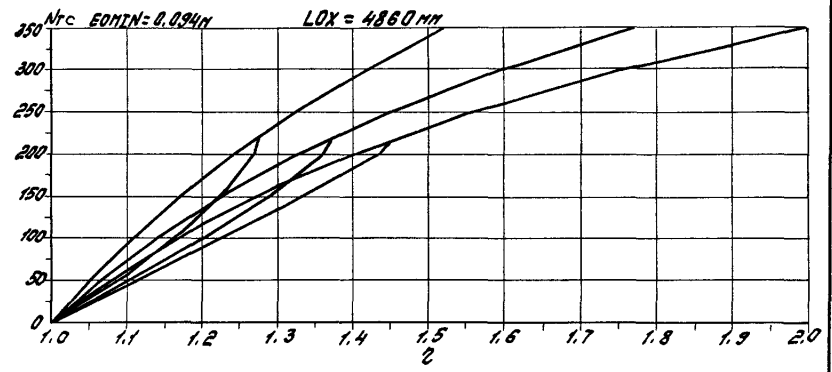
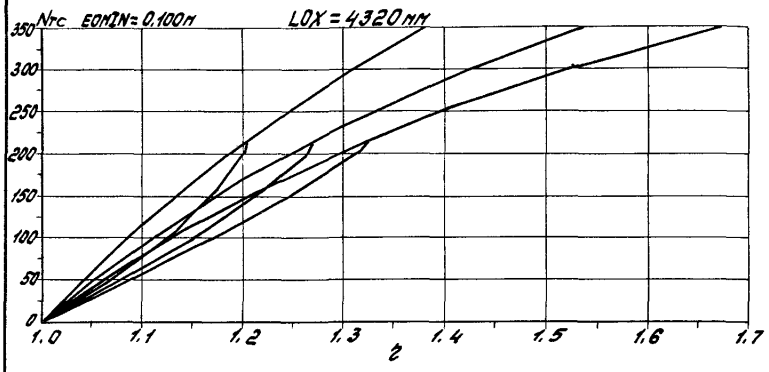

Угол наклона, градуса вправо от нуля

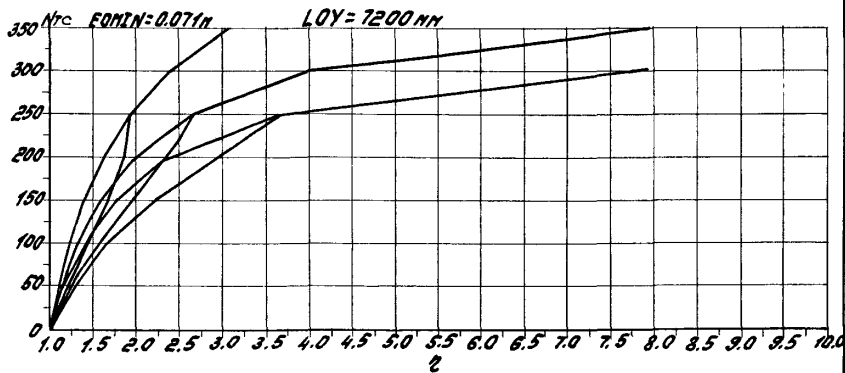
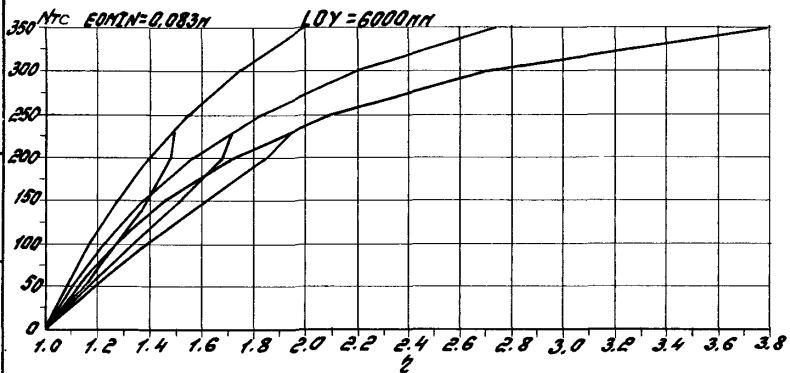
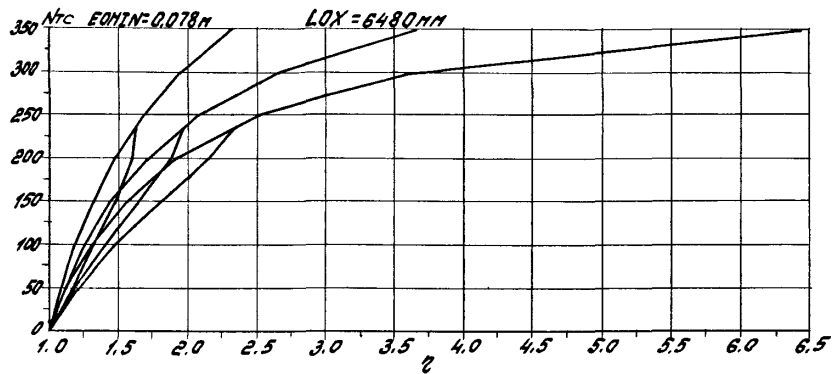
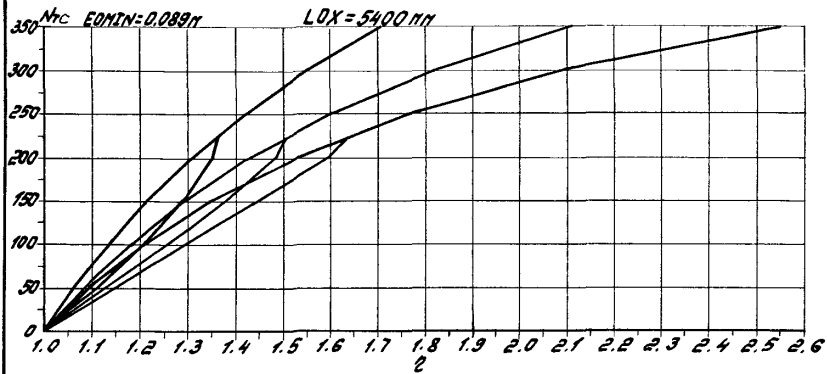

Лист № 172 из 172

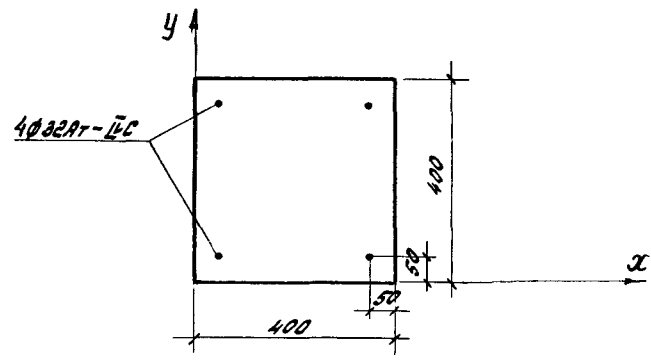
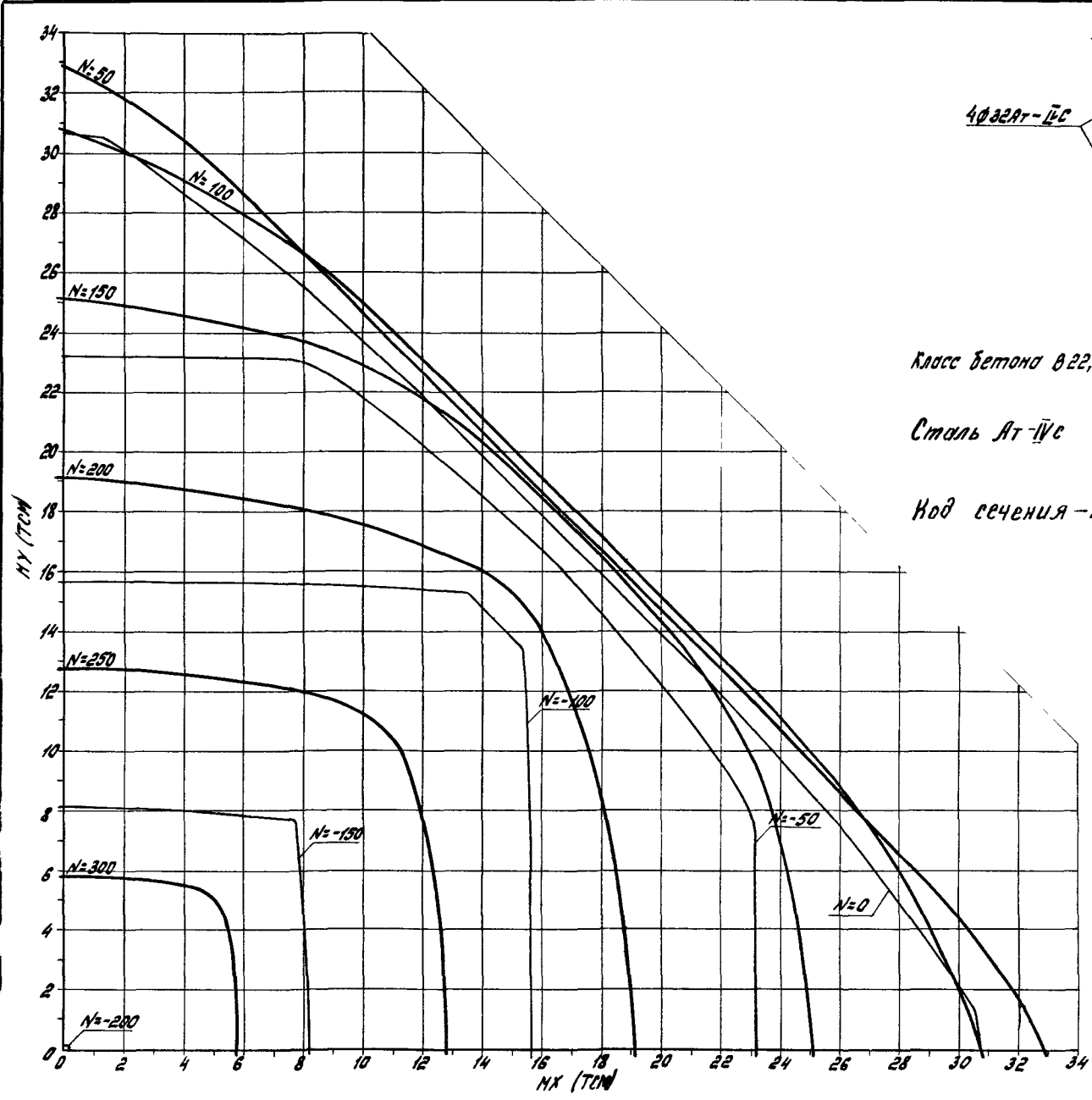

Класс бетона В22,5 ($R_b = 11$, $\gamma_{b2} = 0.90$)

Сталь А1-1C

Код сечения - 122Б

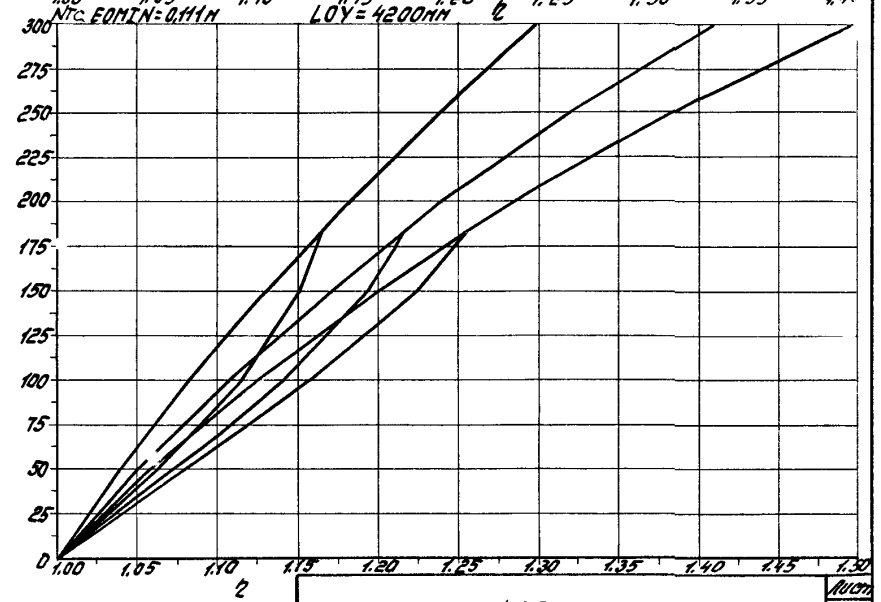
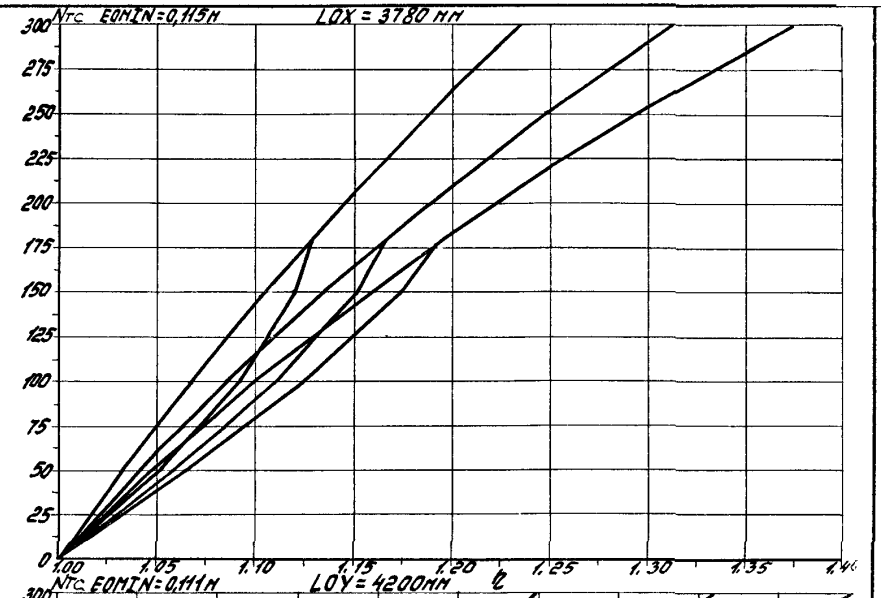
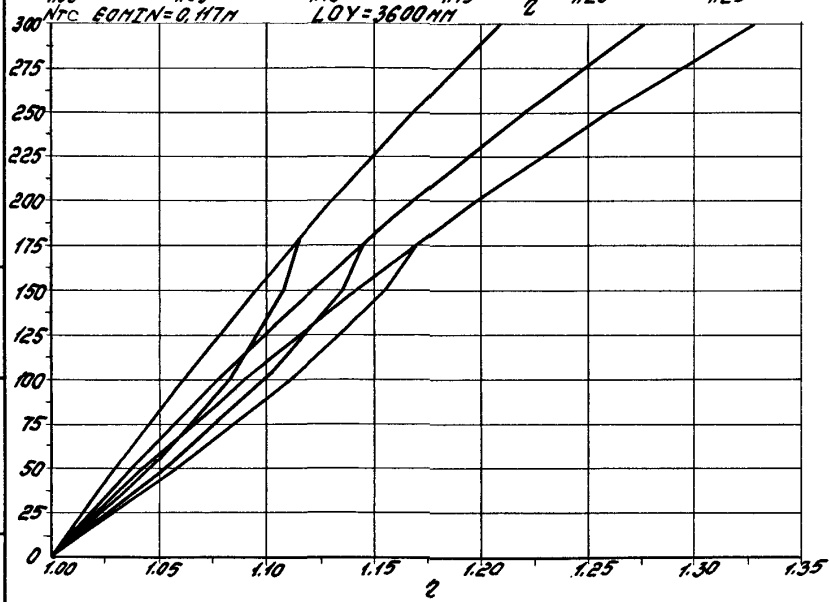
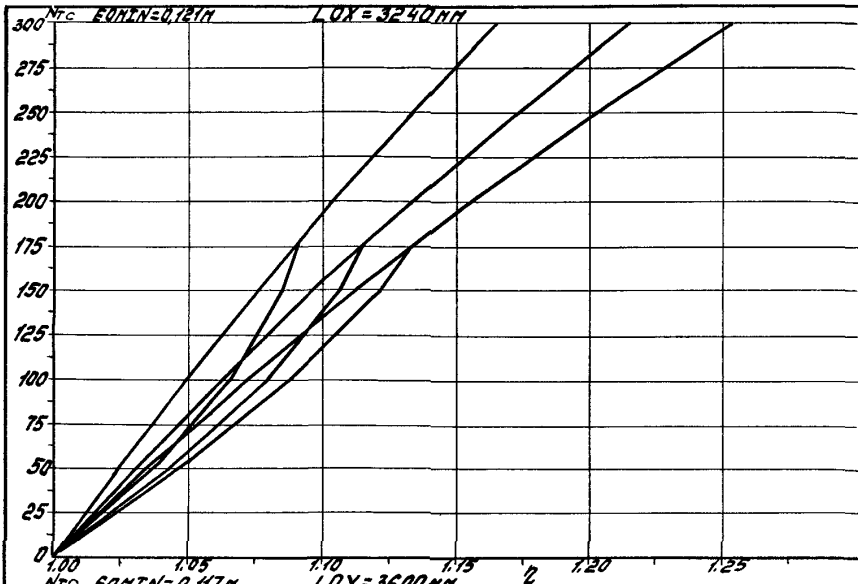

Длина по оси, мм

1.020.1-4 0-9 002

174

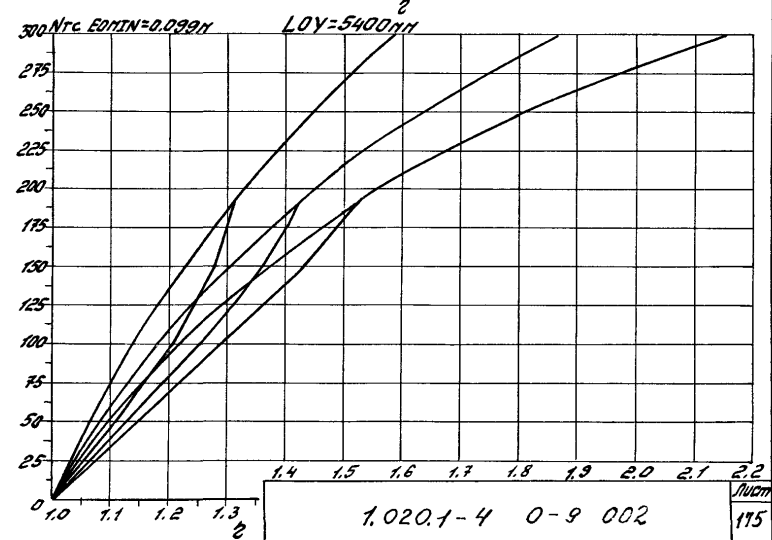
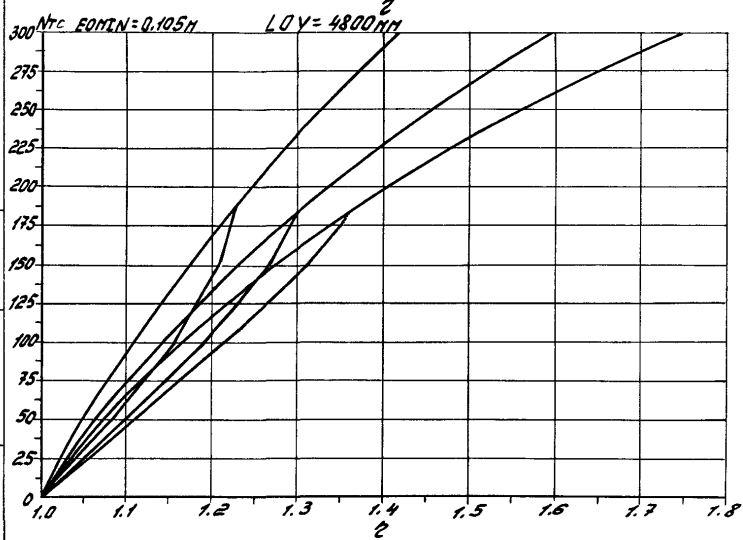
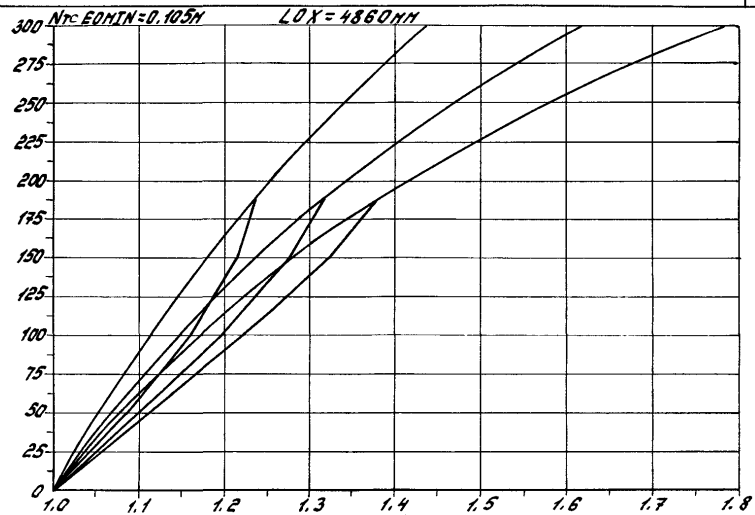
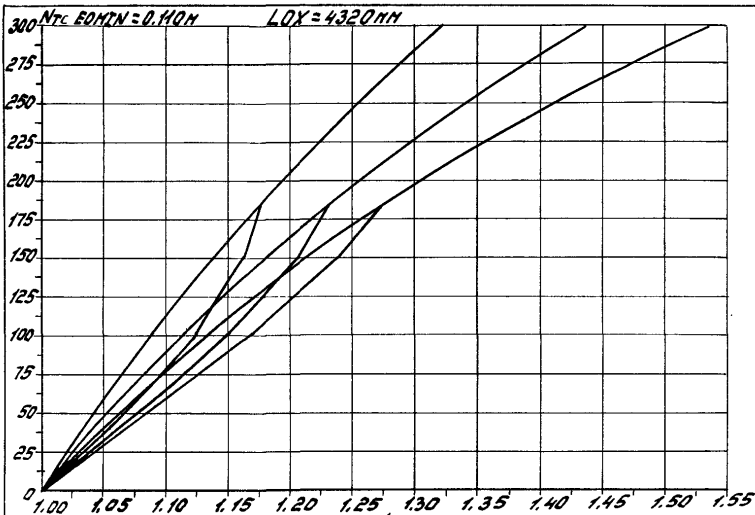

ИЗОМЕТРИЧЕСКИЕ ПОЛЯРЫ В ПЕРИОД ВВОДА

1.4 1.5 1.6 1.7 1.8 1.9 2.0 2.1 2.2
μm

1,020.1-4 0-9 002

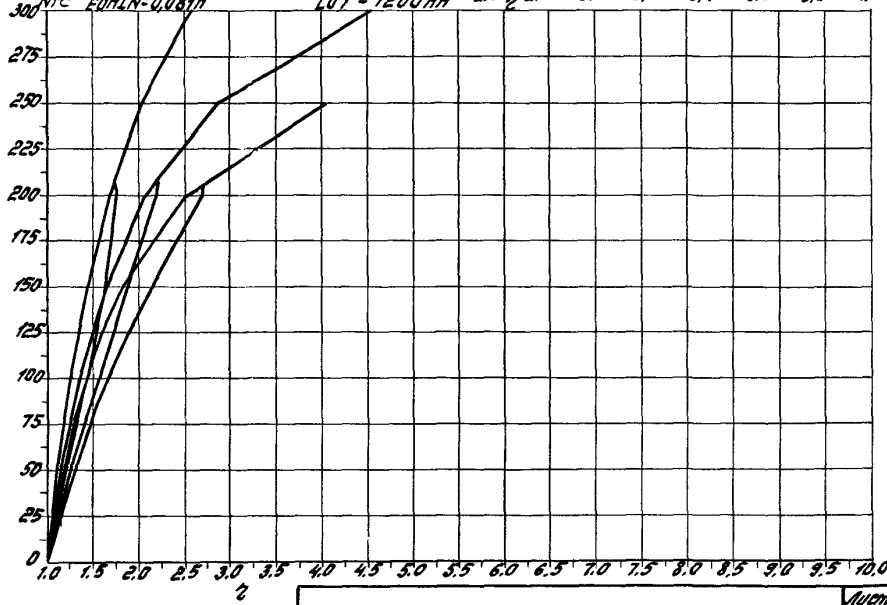
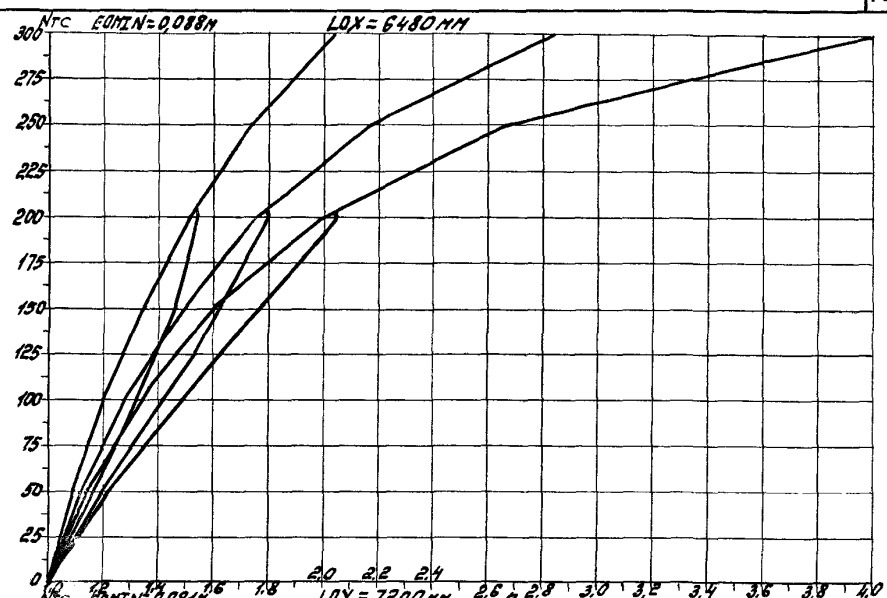
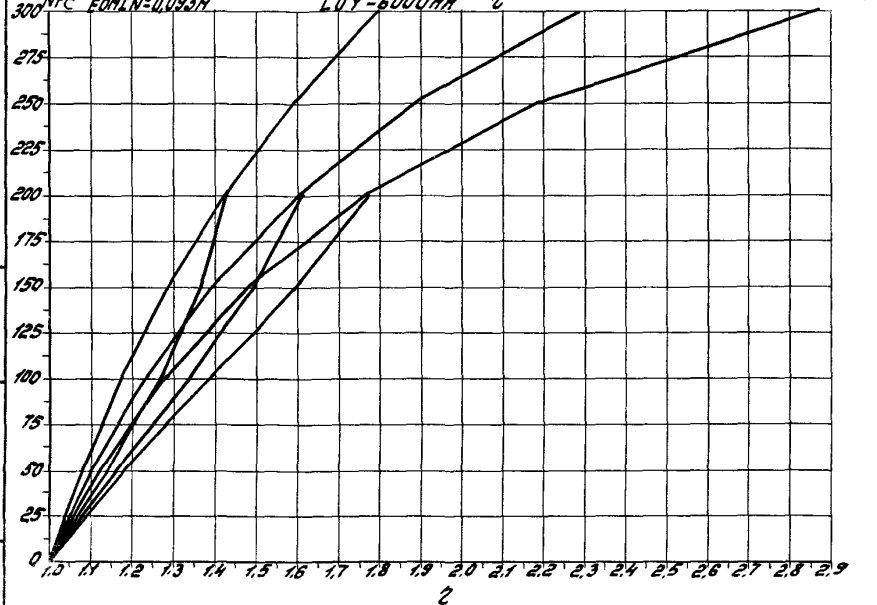
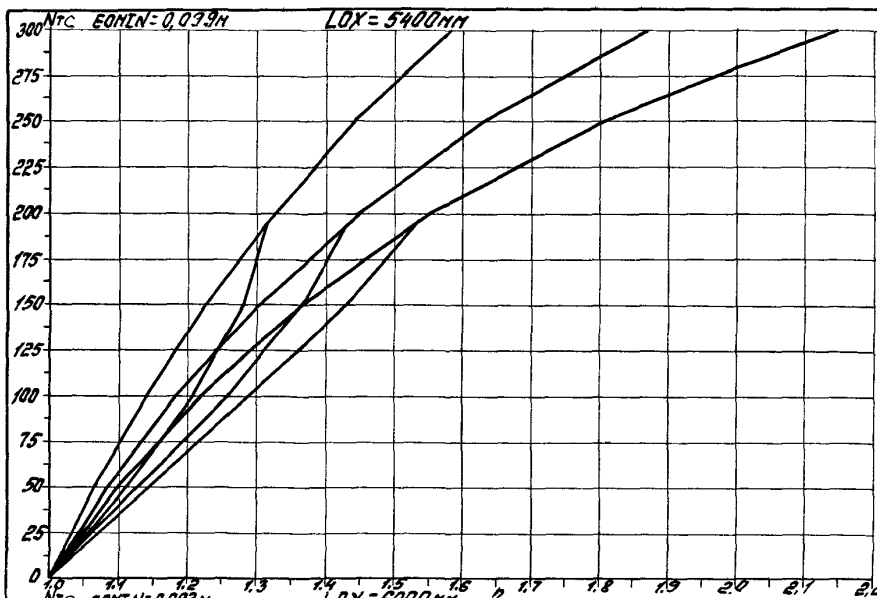

Упб. К. 11000. Матрицы и зерно. Векторное

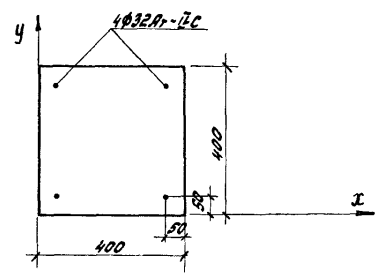
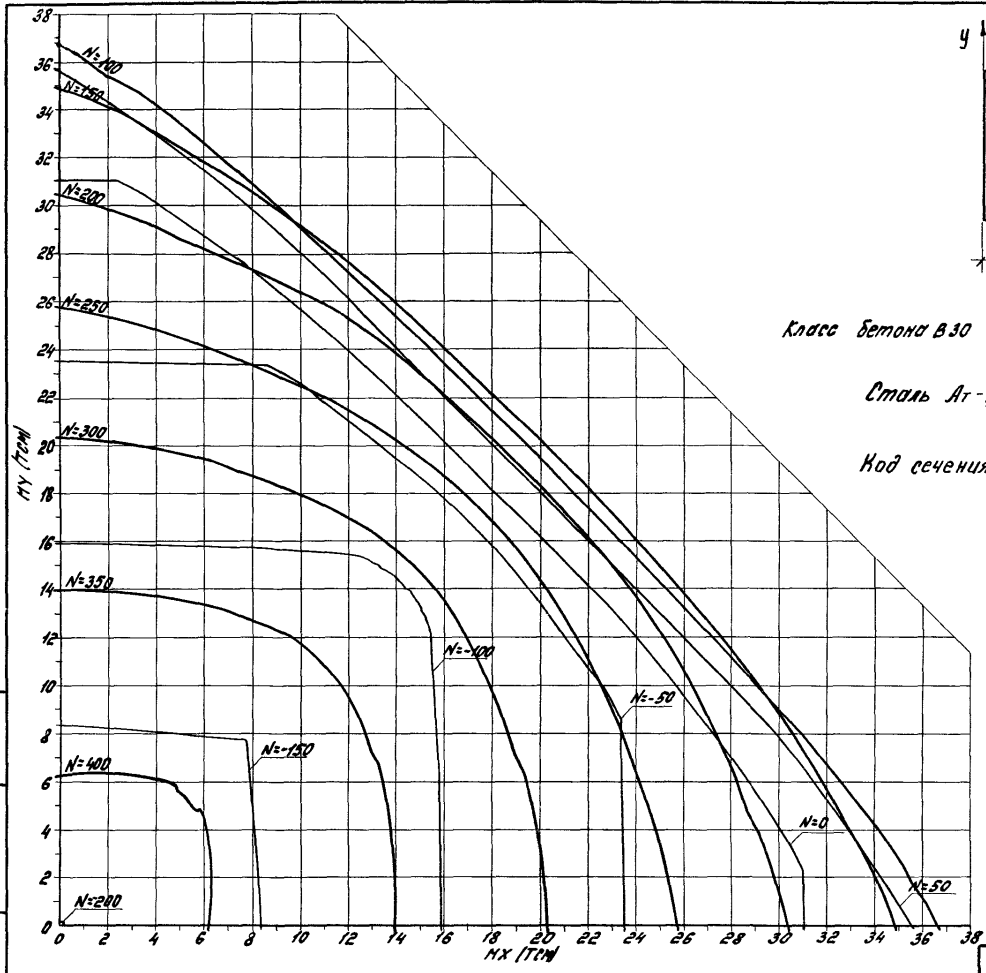

Класс бетона В30 ($R_b=18$, ТМЛ при учёте $\gamma_{b2}=1,10$)

Сталь Ат-IVС

Код сечения - 123а

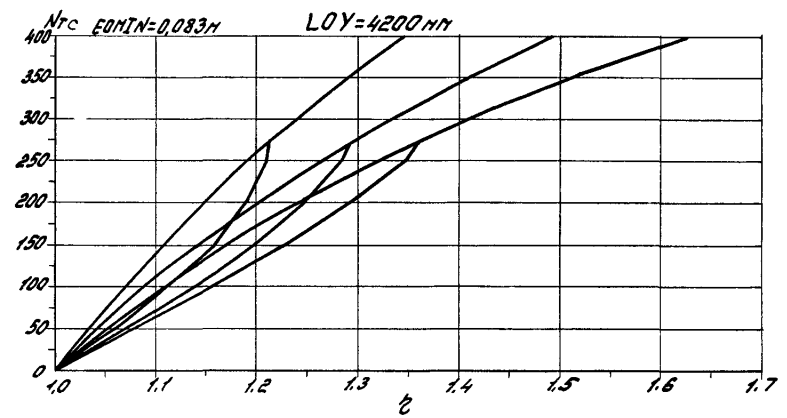
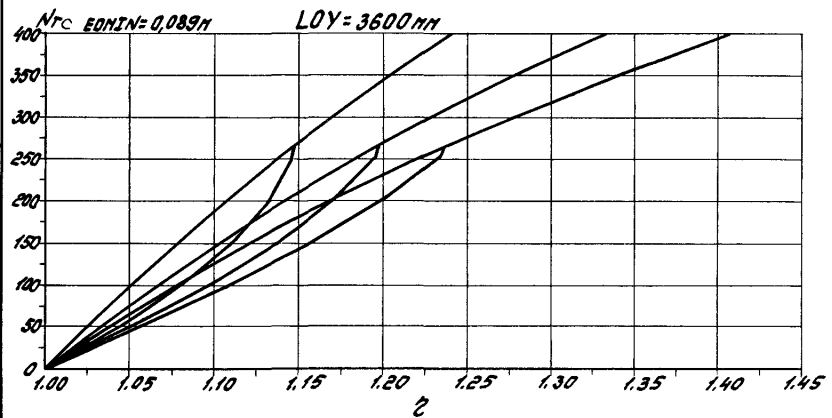
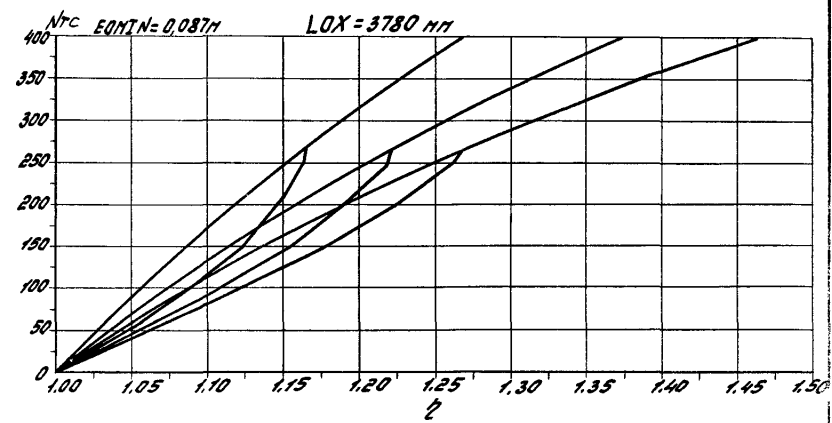
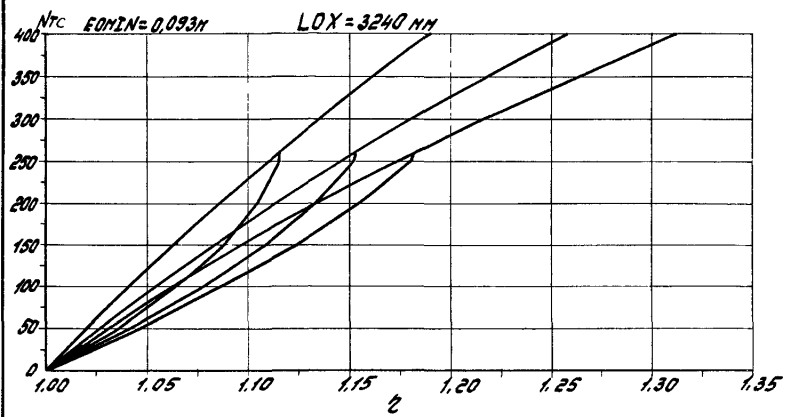

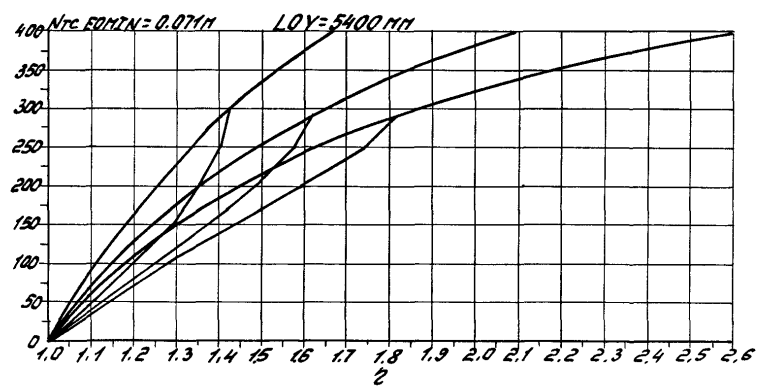
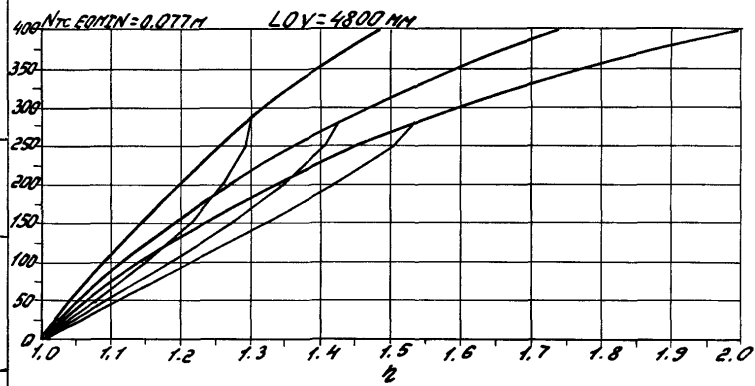
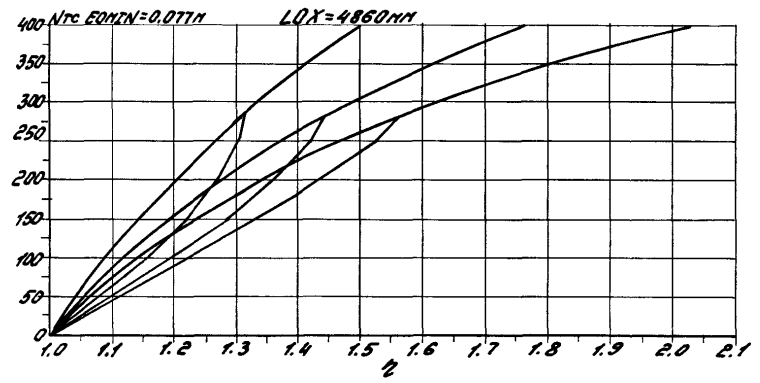
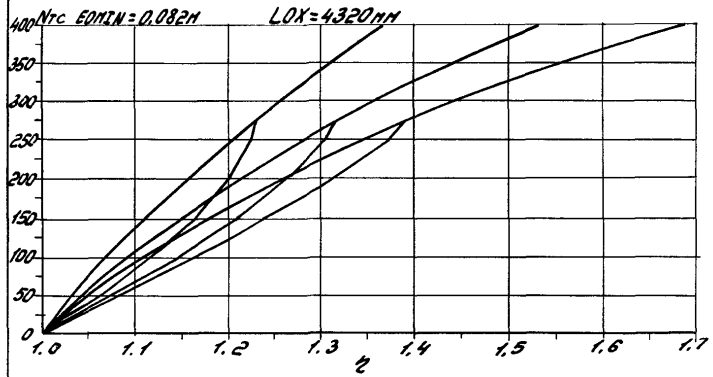

Ушб. А. Раҳимов, М. Раҳимов ва бошқалар. 1984 й. 1-қ. 179-180-бет.

1.020.1-4 0-9 002 179

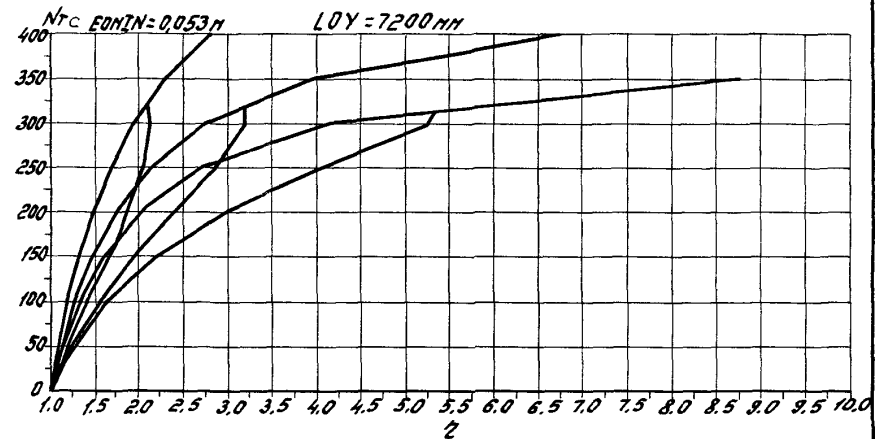
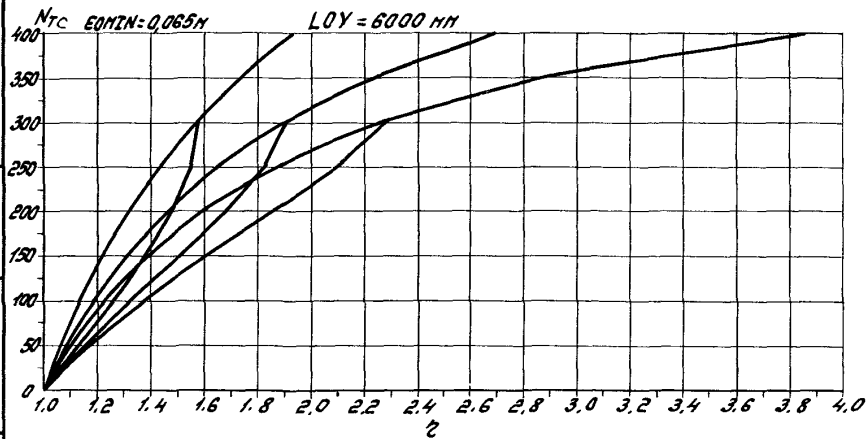
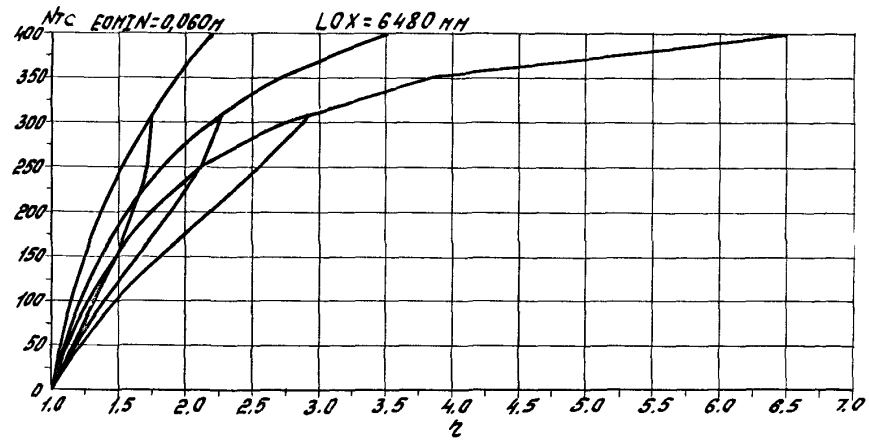
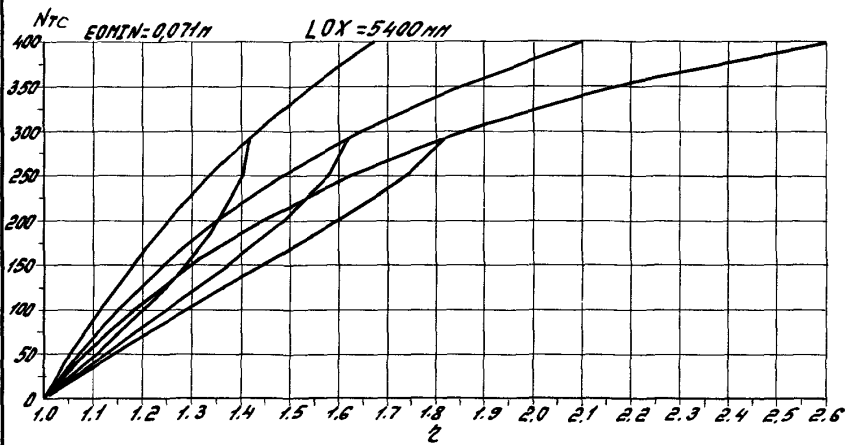

1.020.1-4 0-9 002

24166-02

85

180

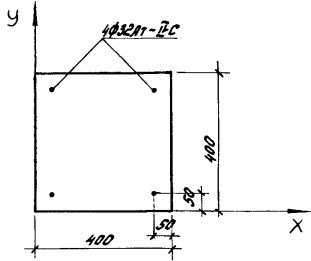
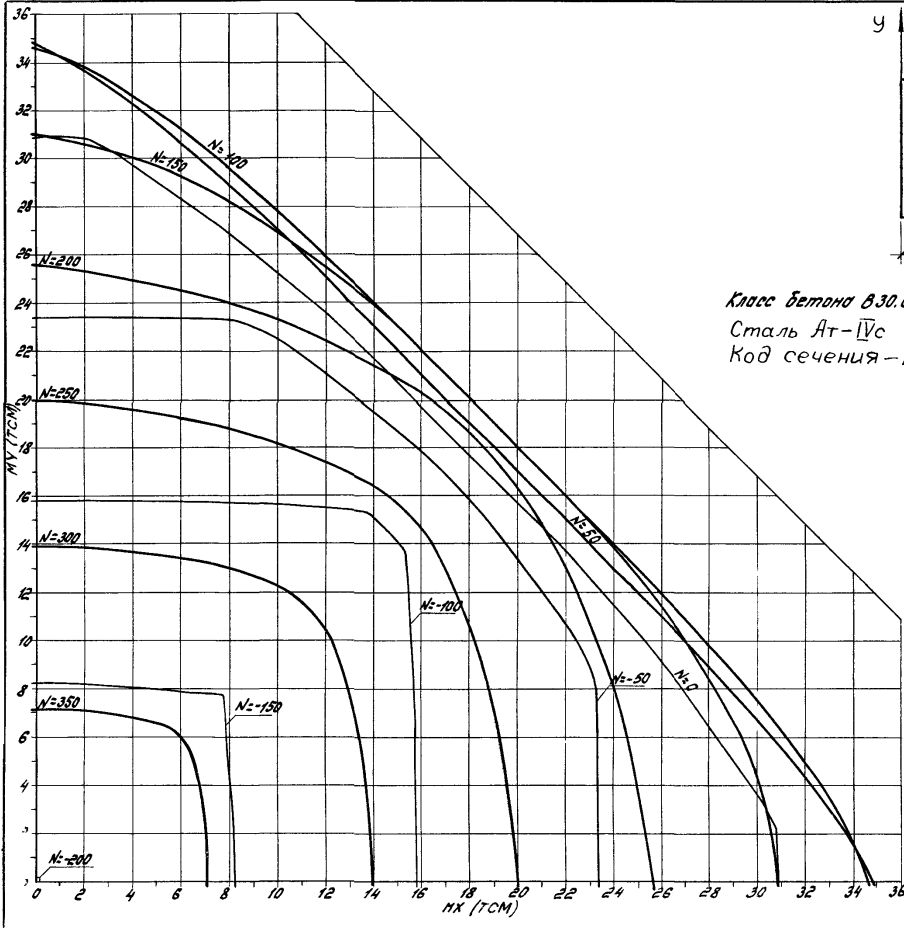

Класс бетона В30.0 ($R_b = 15.3 \text{ МПа}$ при учёте $\gamma_c = 0.90$)
 Сталь Аt-IVc
 Код сечения - 123б

1.020.1-4 0-9 002

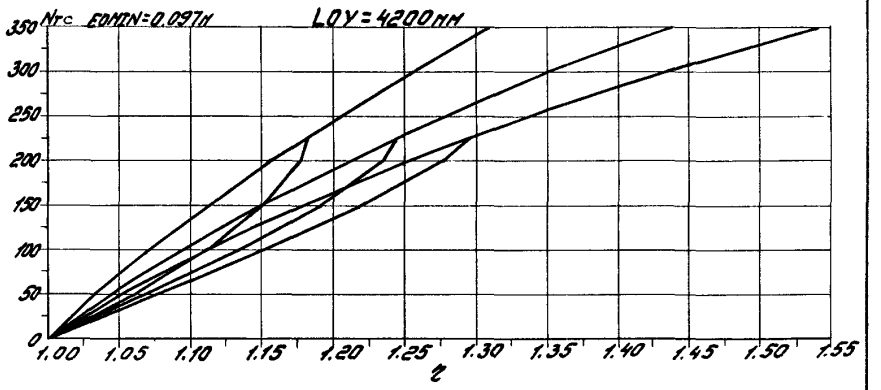
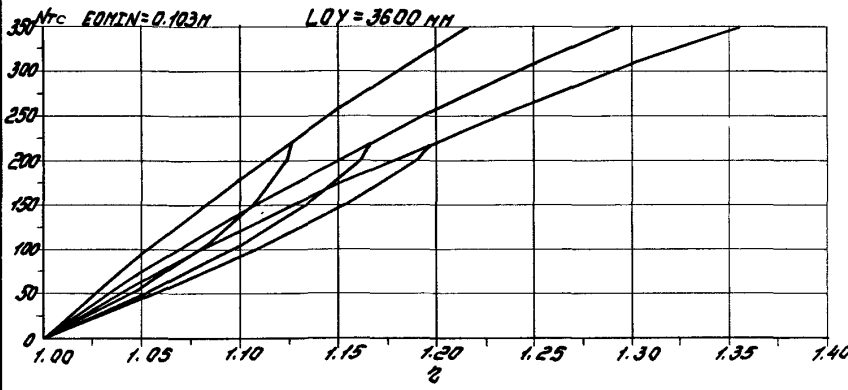
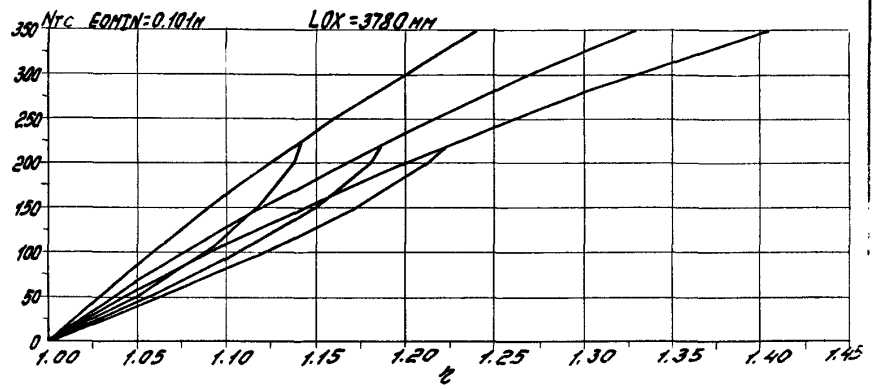
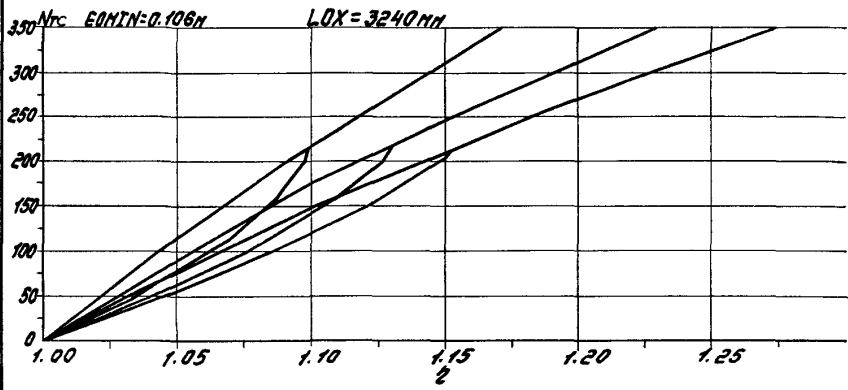

Виде А.А. 10/20/2011

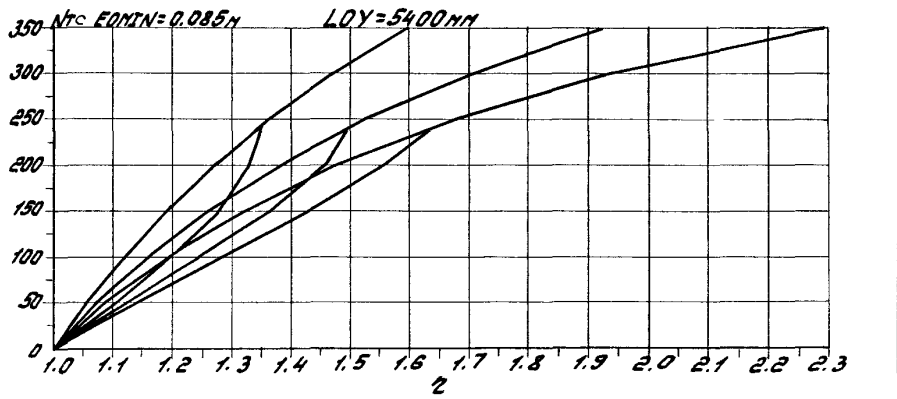
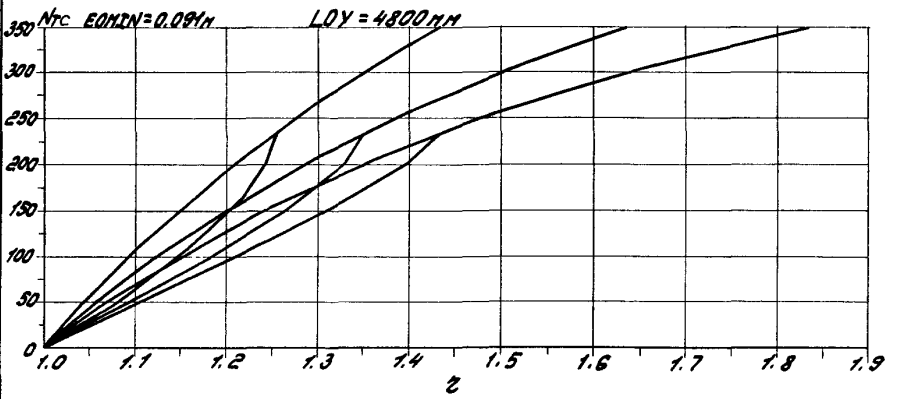
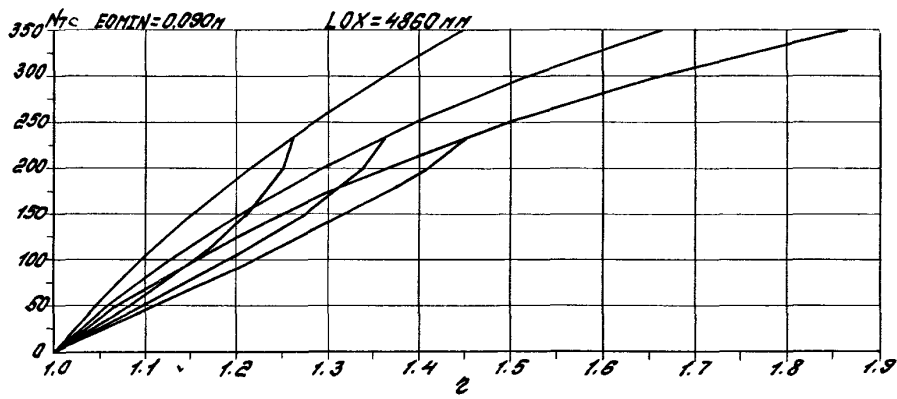
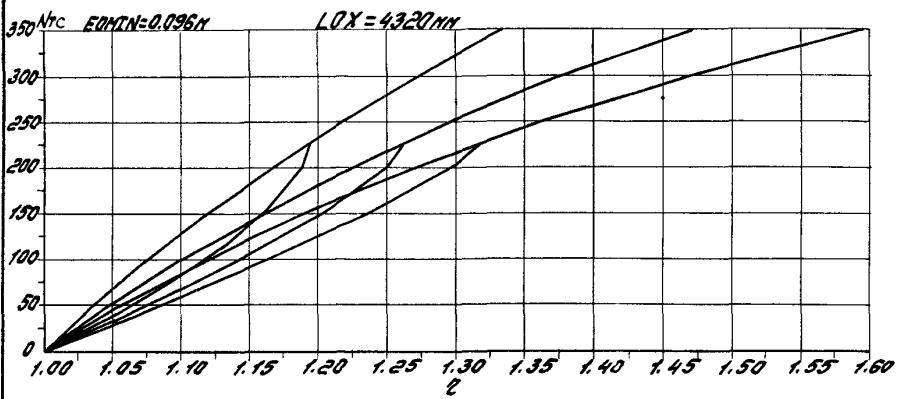

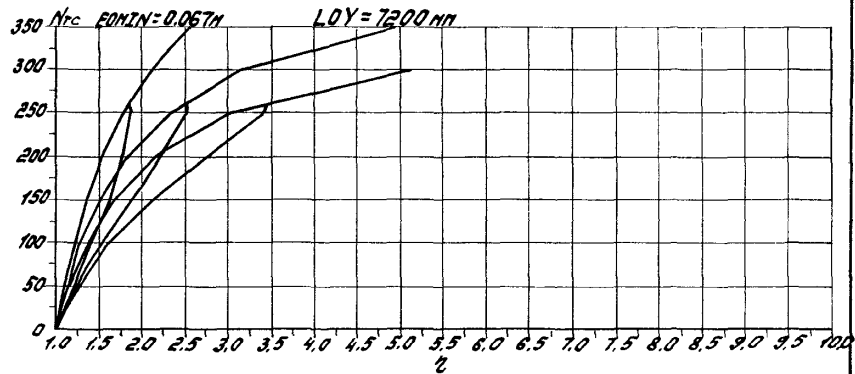
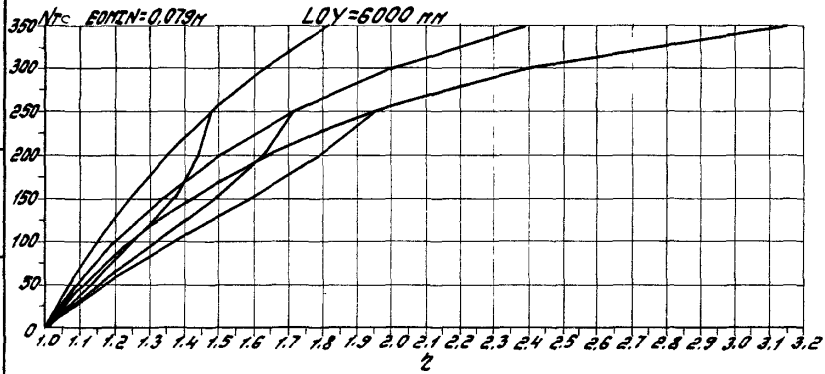
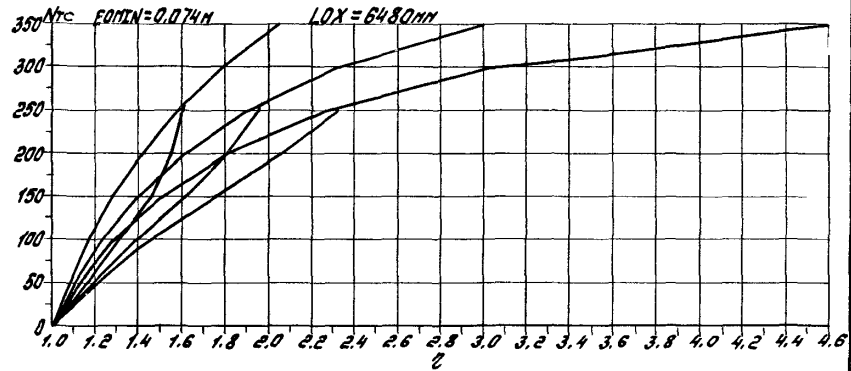
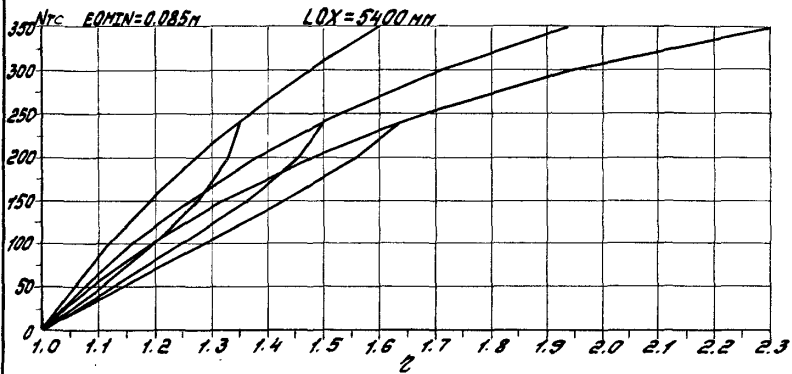

1.020.1-4 0-9 002

1.020.1-4 0-9 002

184

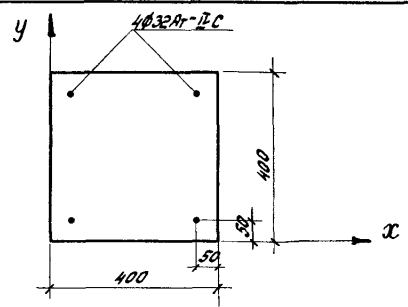
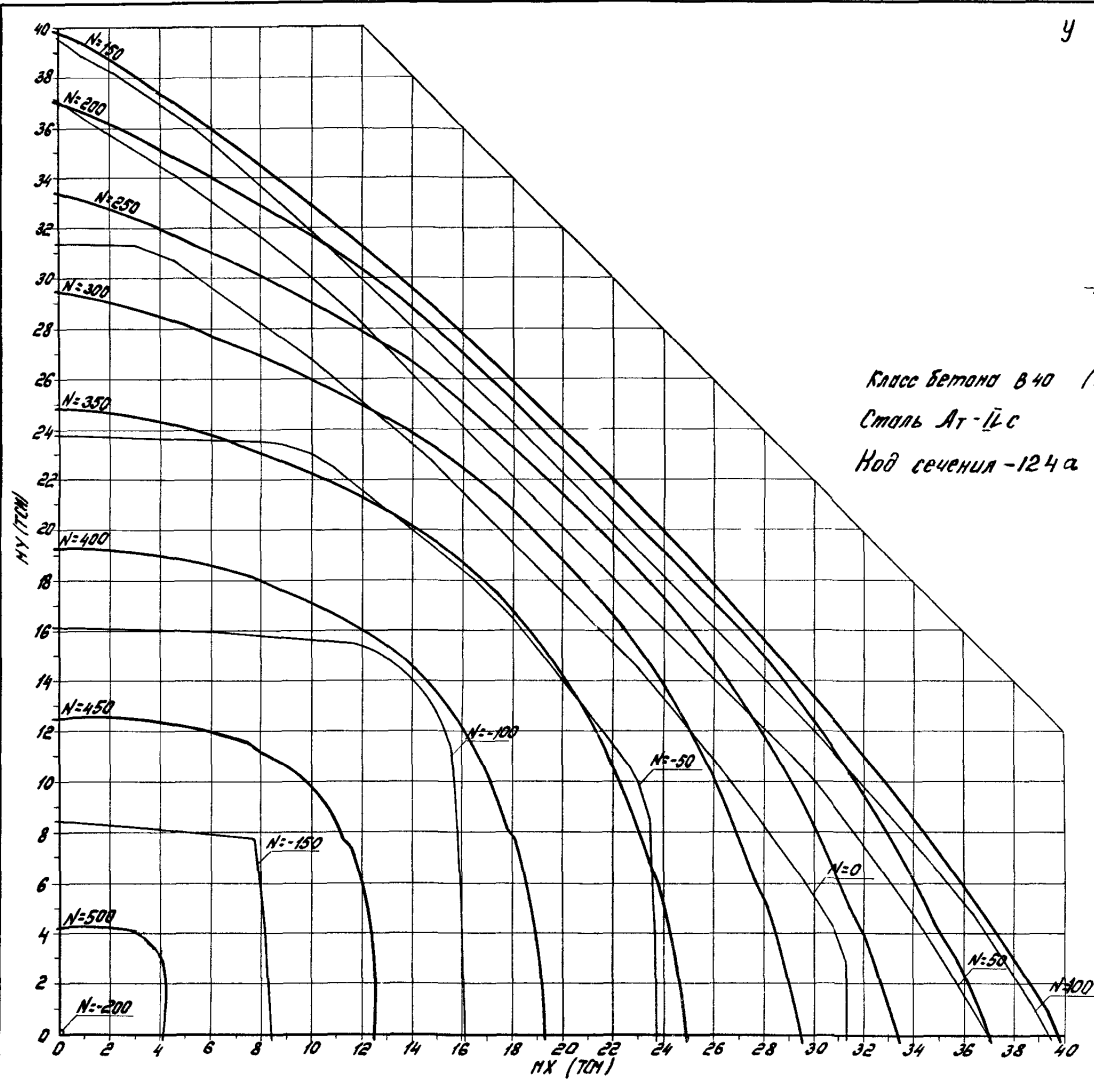

Класс бетона В40 ($R_b = 24,2$ МПа при учёте $f_{R2} = 1,10$)
 Сталь А1-12С
 Нод сечения -124а

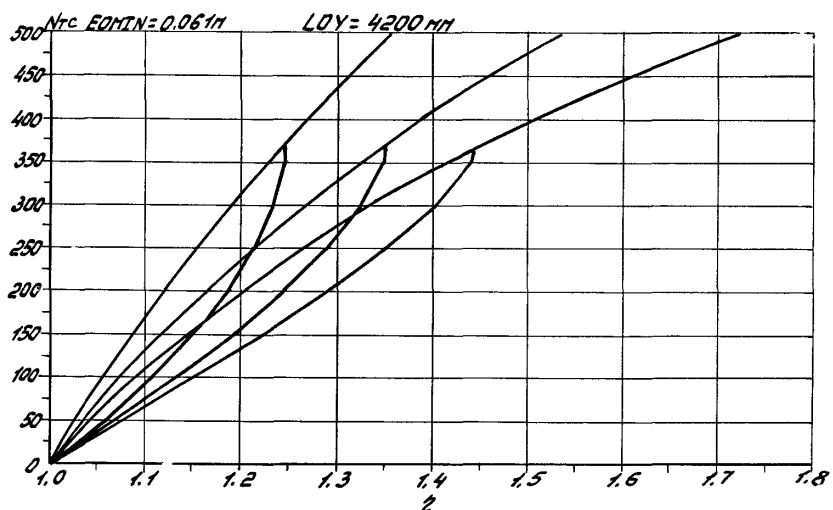
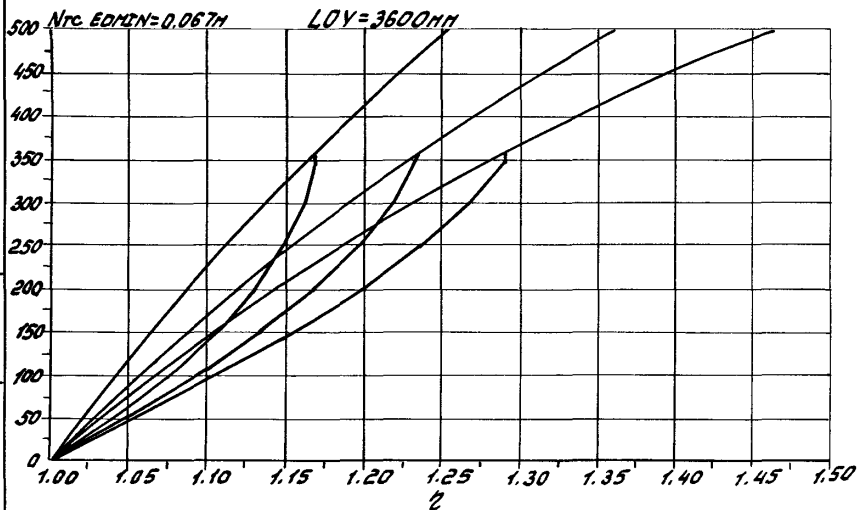
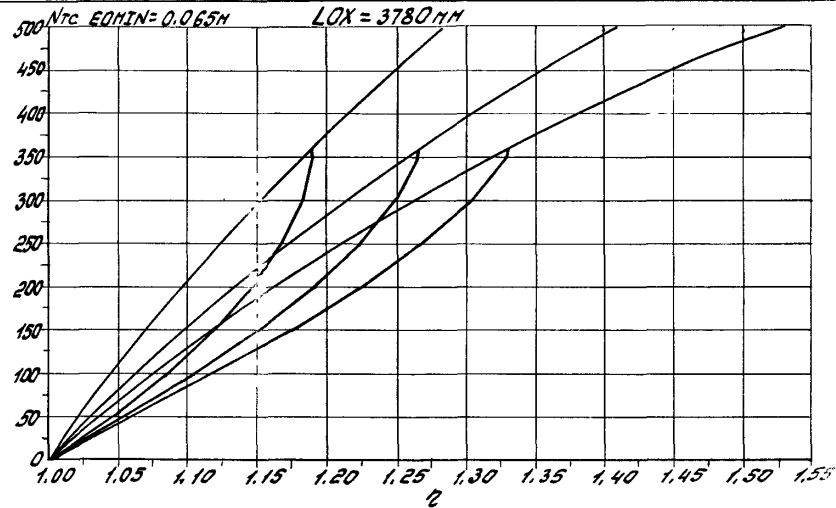
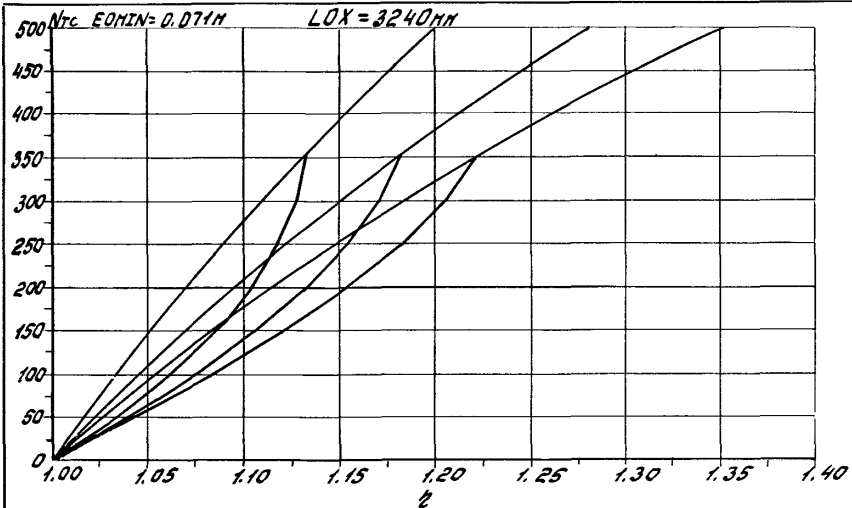

1,020.1-4 0-9 002 11/20/66
186

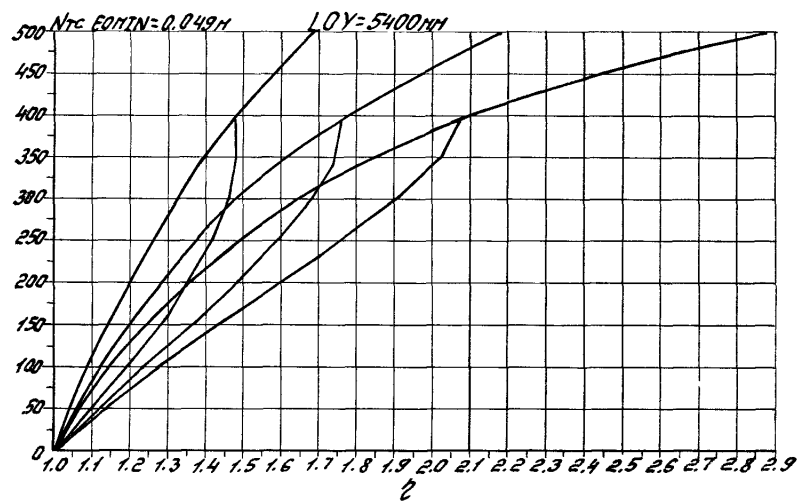
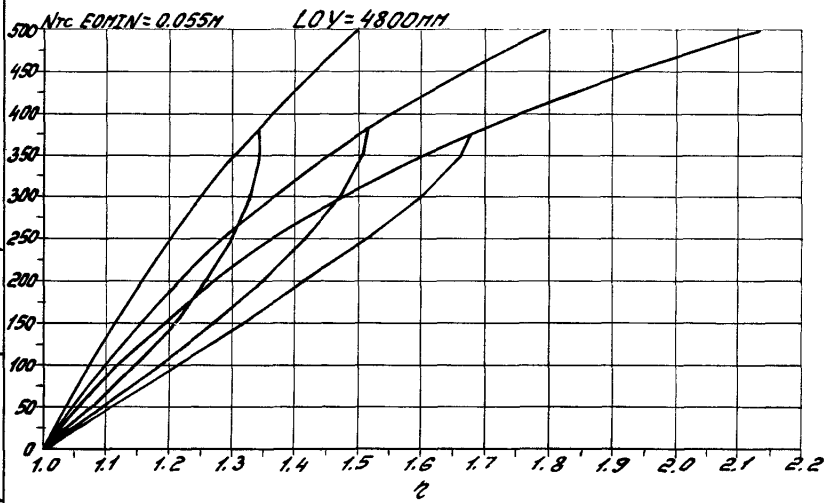
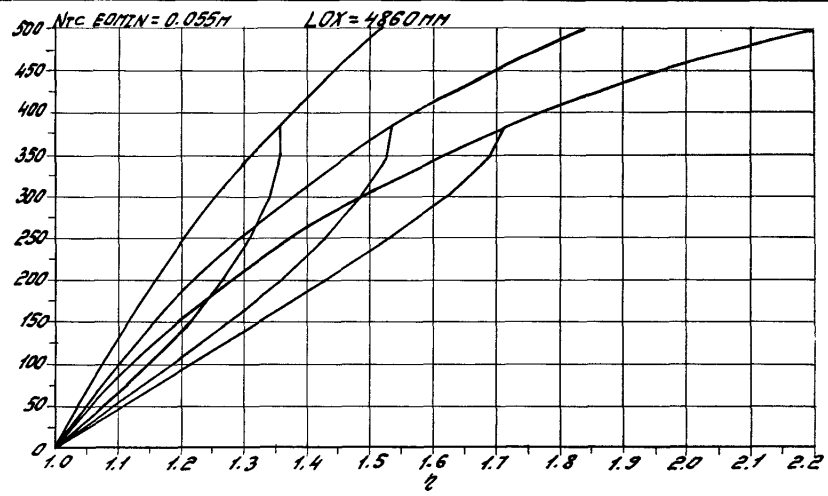
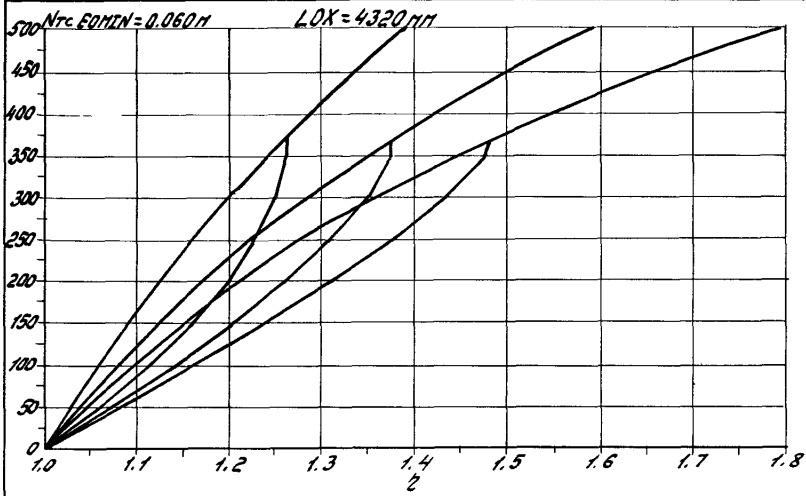

Вид в плане

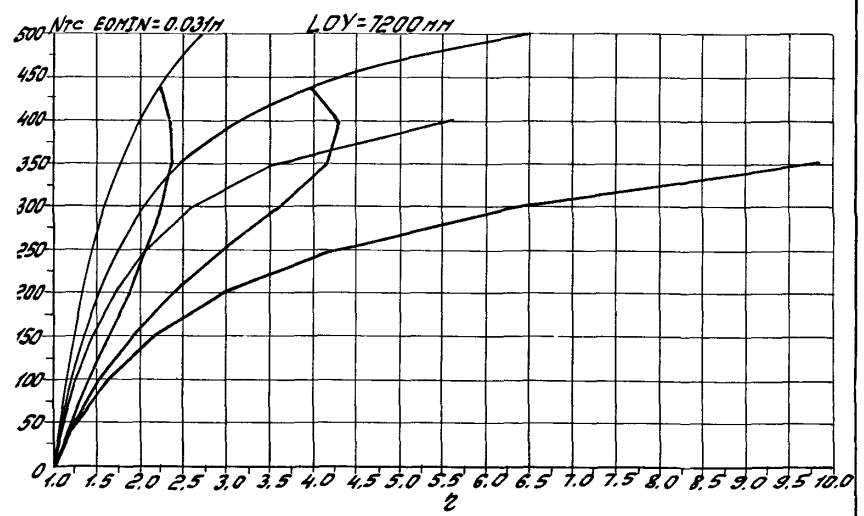
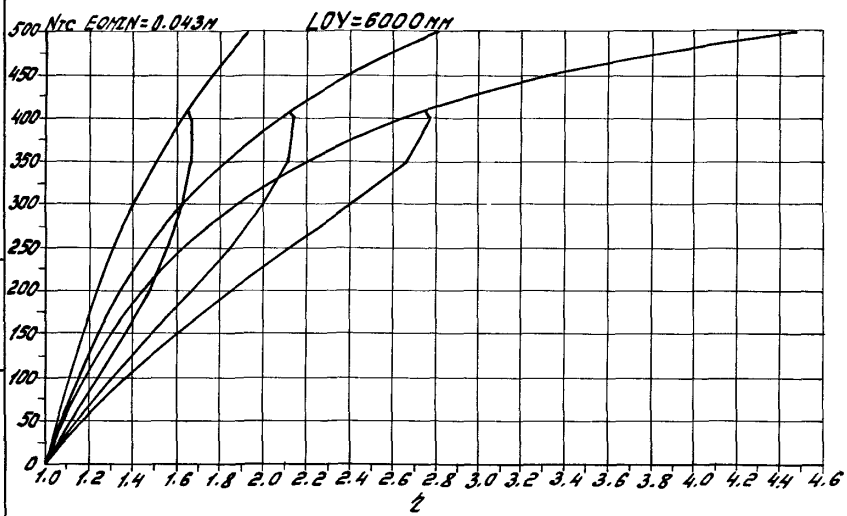
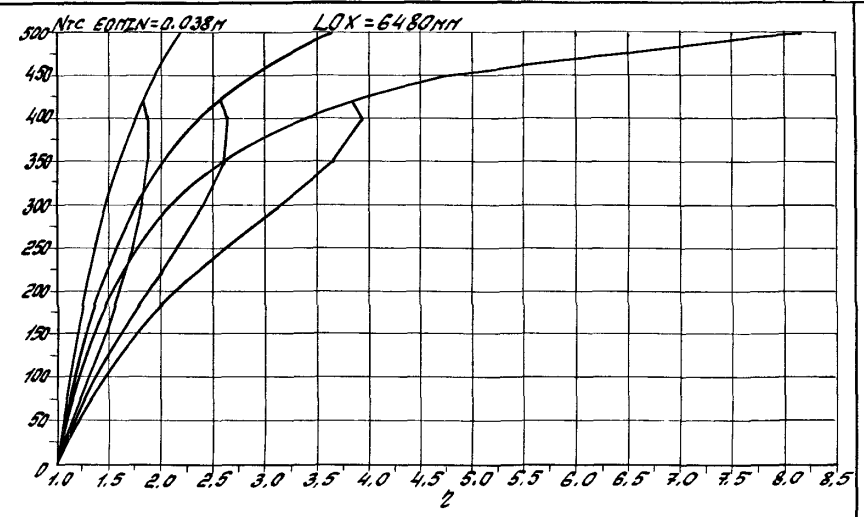
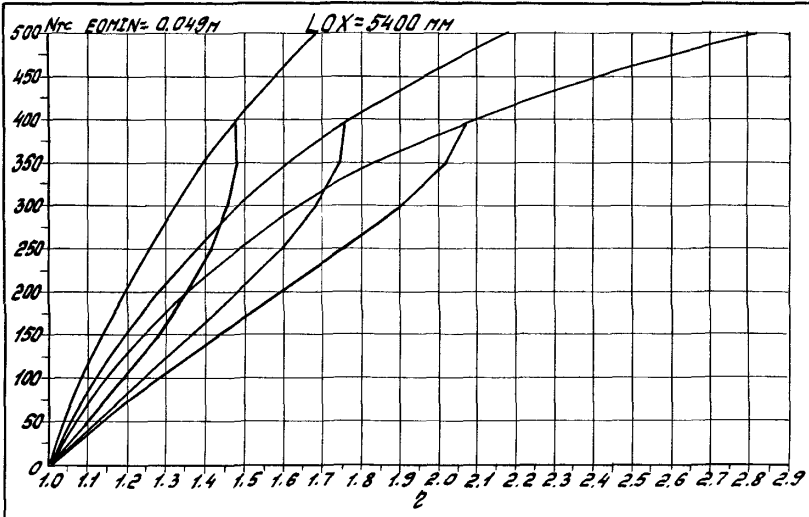

Упр. № 10001. Продукция УЗСМ. ВЗСМ. УМБ. М

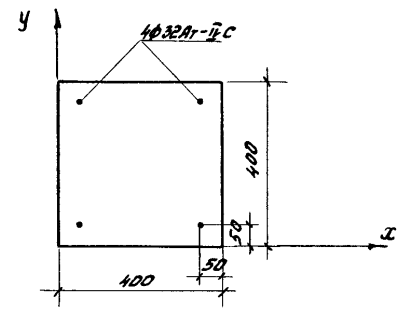

Класс бетона В40 ($R_b = 1,8 \text{ МПа}$ при учёте $\gamma_{b2} = 0,90$)

Сталь А-I-IVс

Код сечения -124Б

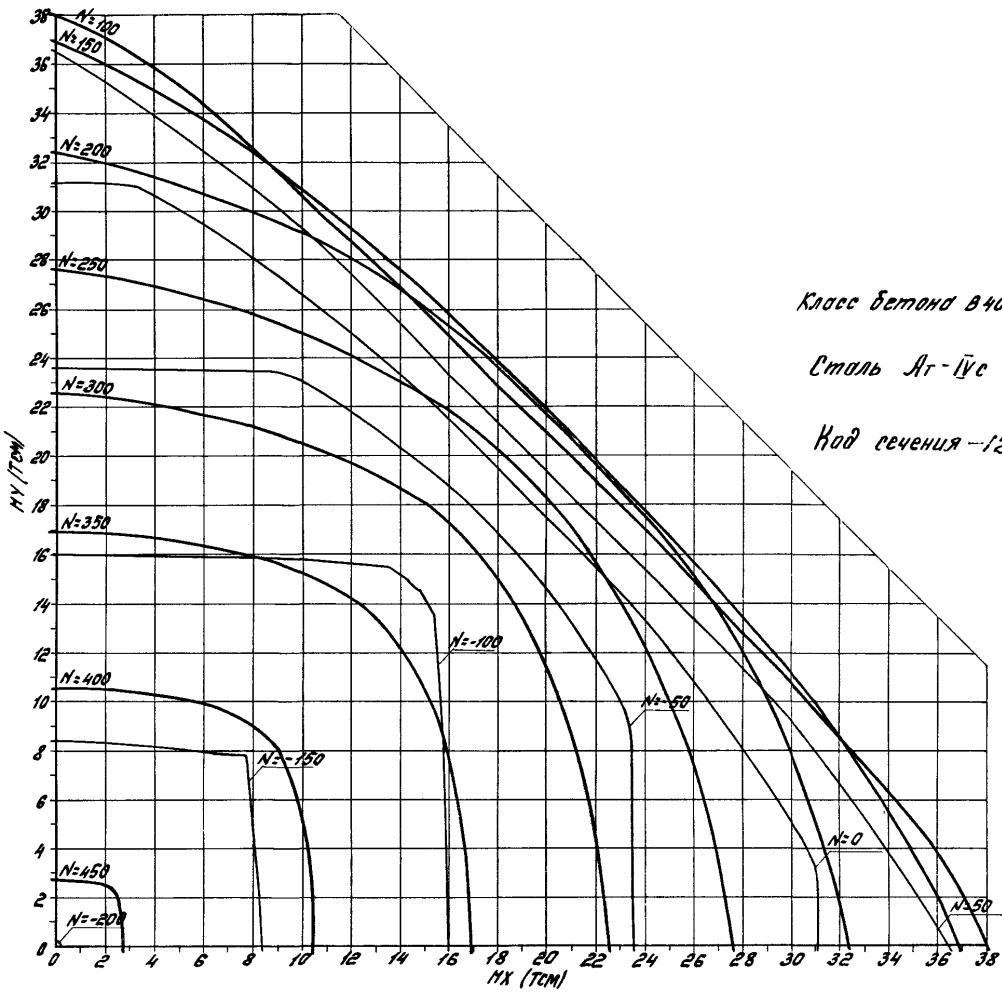

вдоль и поперек

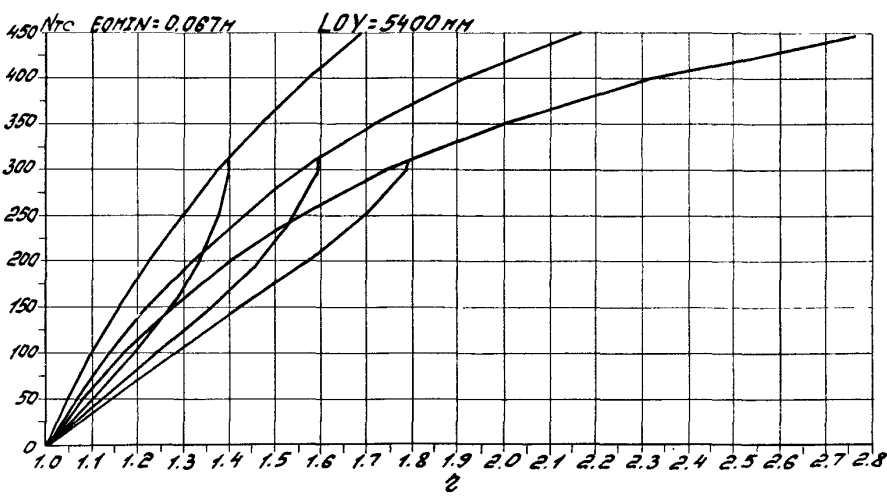
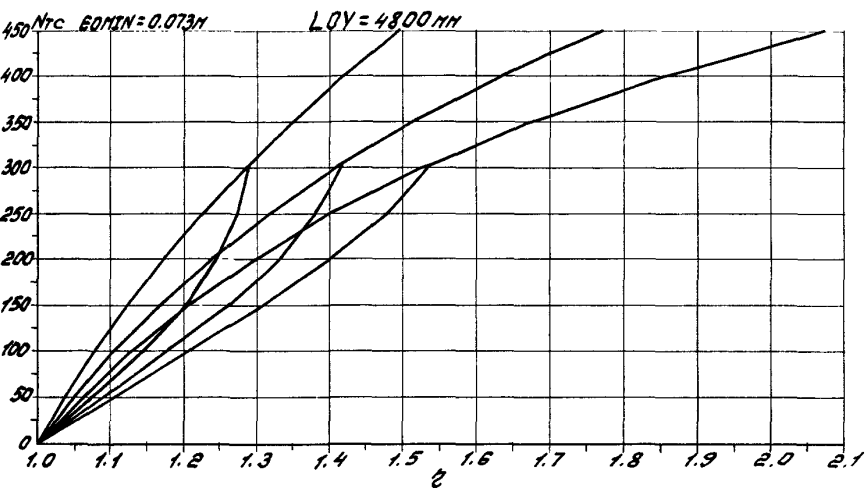
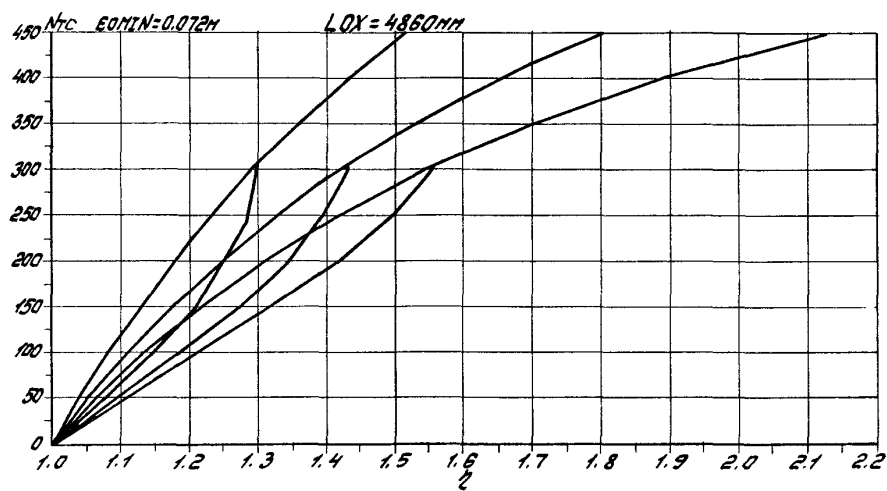
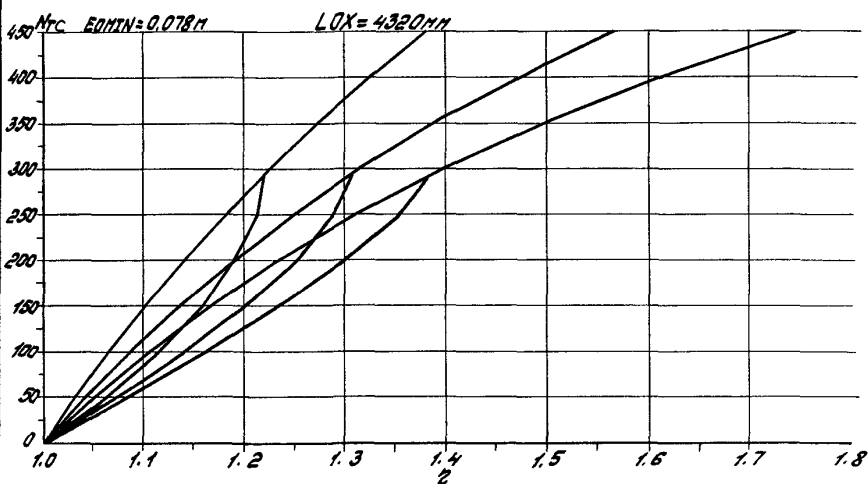

Уд. А. 1000/1000 (по числу в строке)

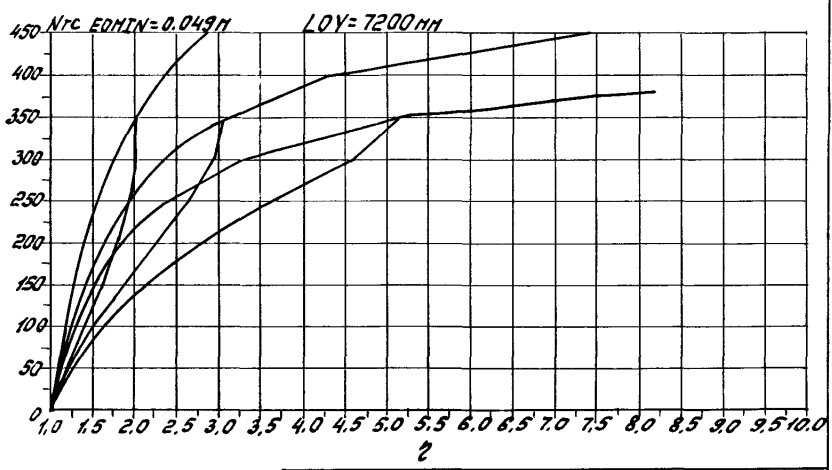
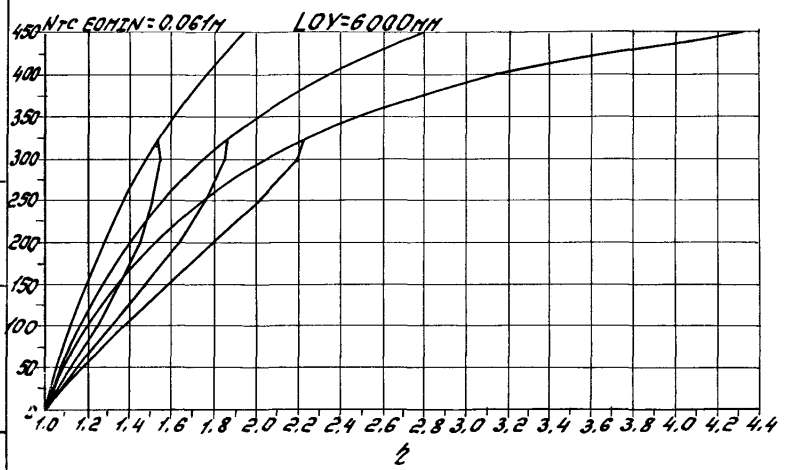
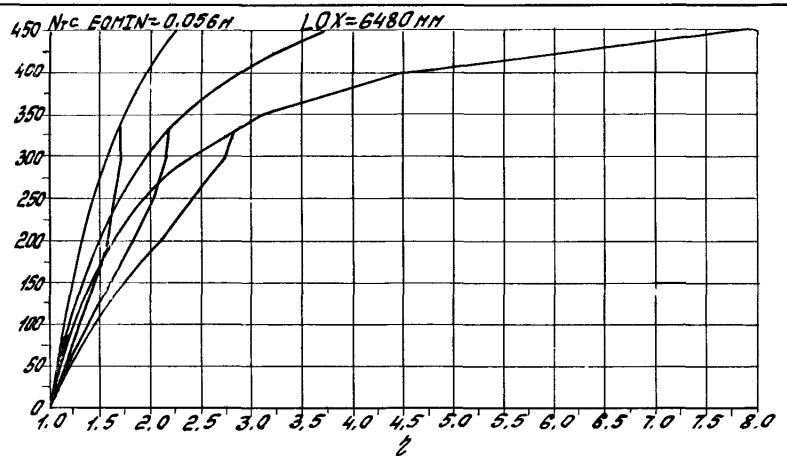
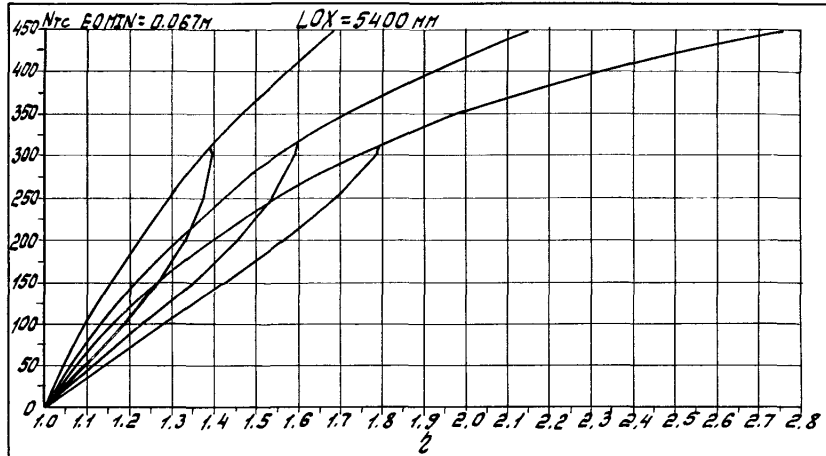

Учб. Машин. Таблицы и диаграммы для расчета

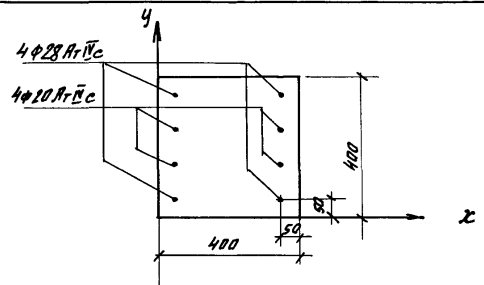
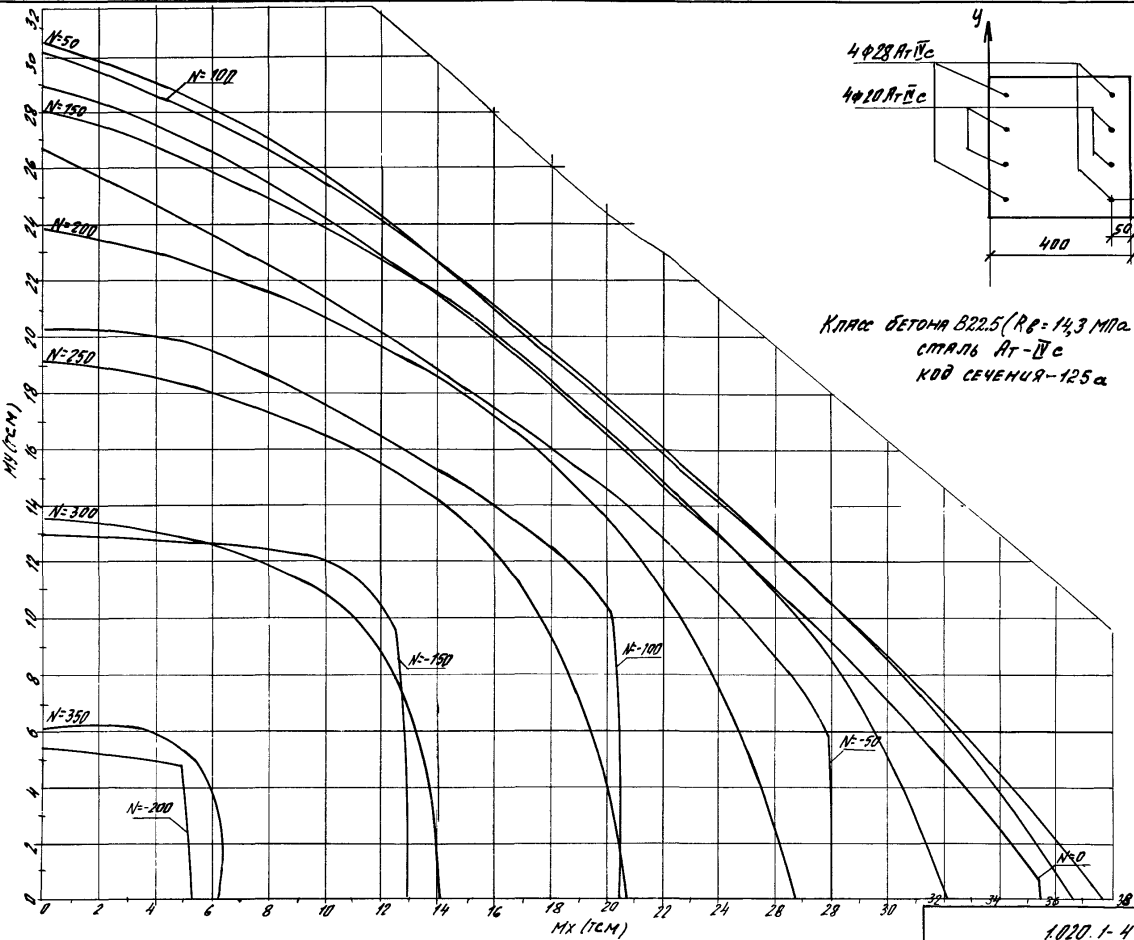

КЛАСС БЕТОНА B22.5 ($R_B = 14.3$ МПа при учете $\gamma_{B2} = 1.10$)
 СТАЛЬ A-I
 КОД СЕЧЕНИЯ-125а

-1071- ВЕРХ УЧАСТКА

1020.1-4 09 002

193

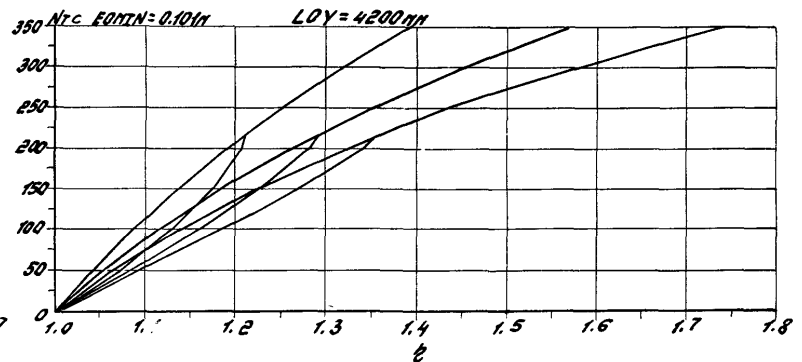
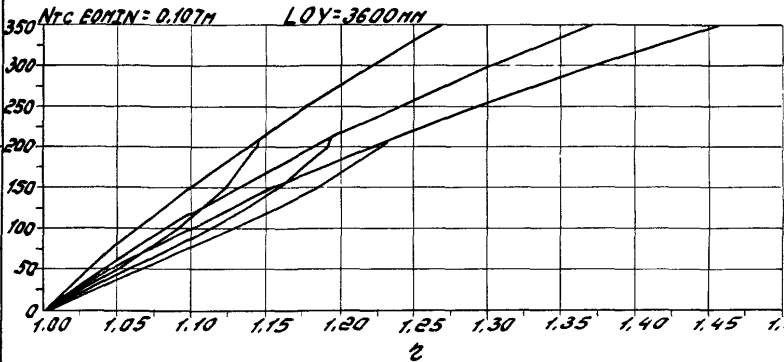
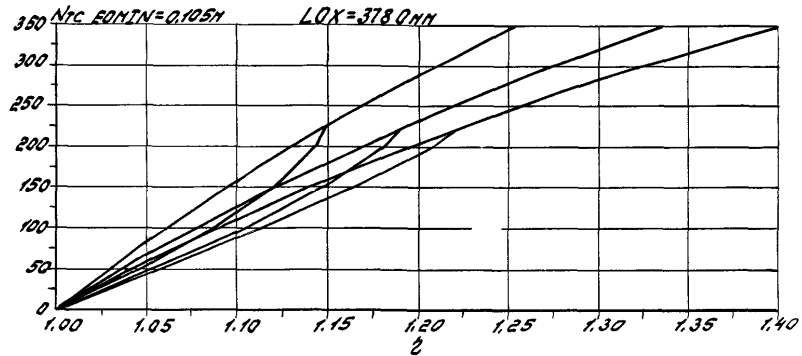
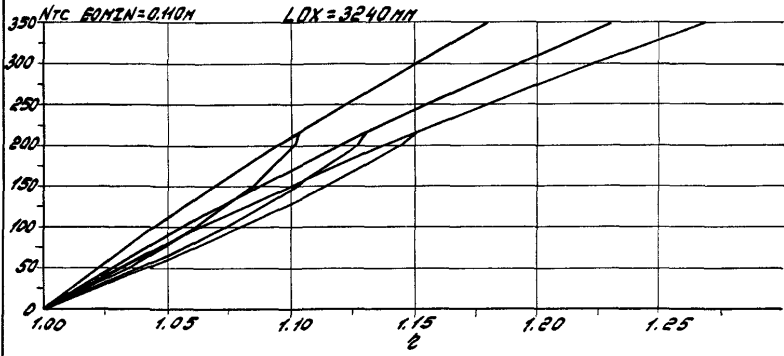

Указ. N. мод. | Точность и формат | Единиц. измерения

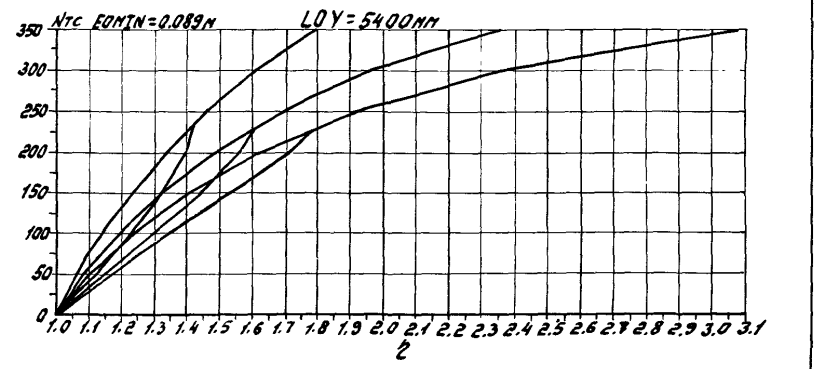
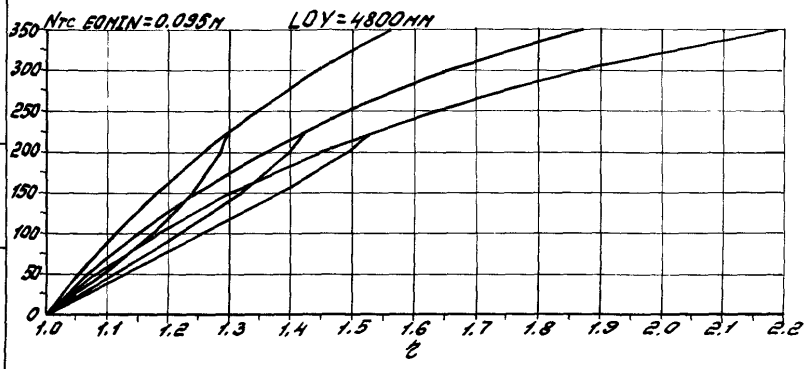
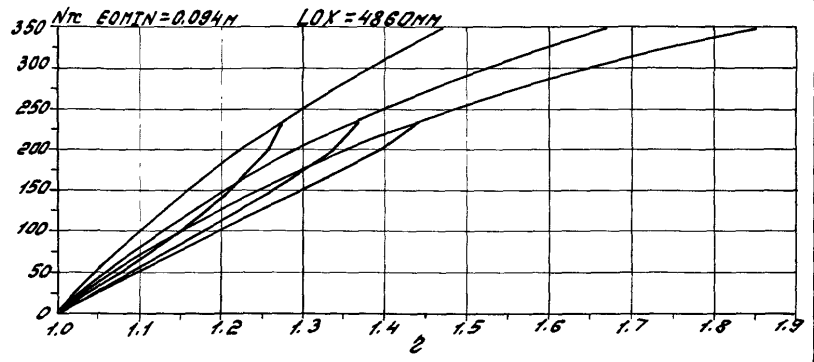
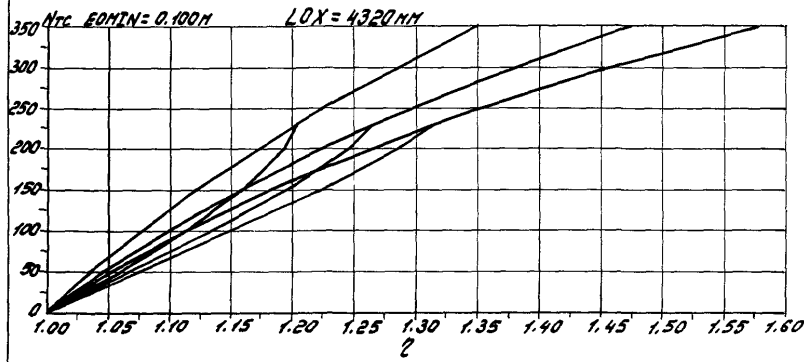

Cb U/min
NTC

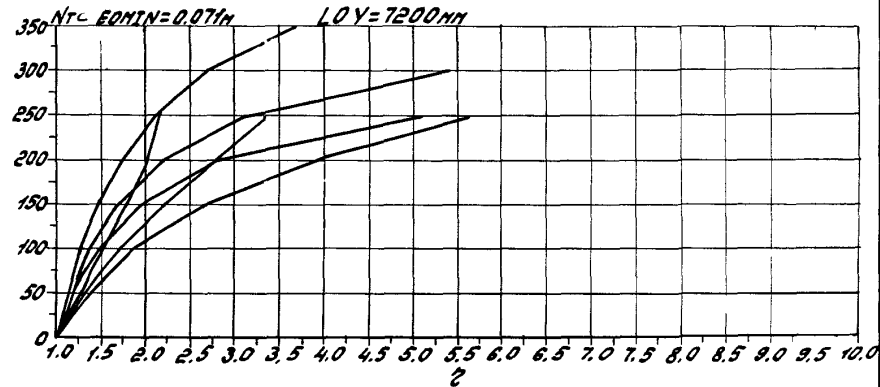
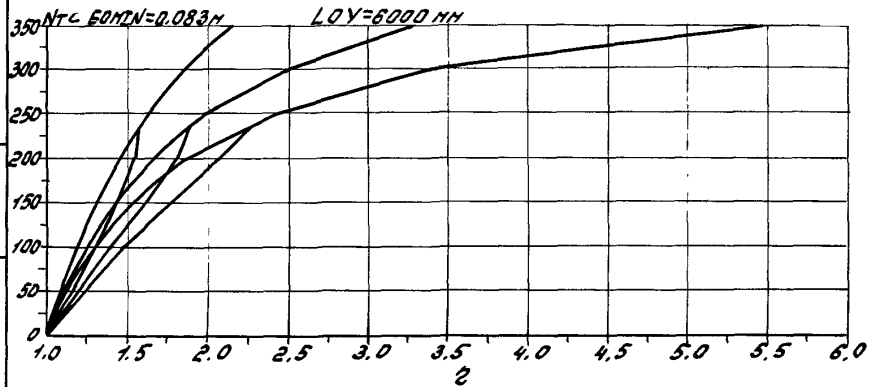
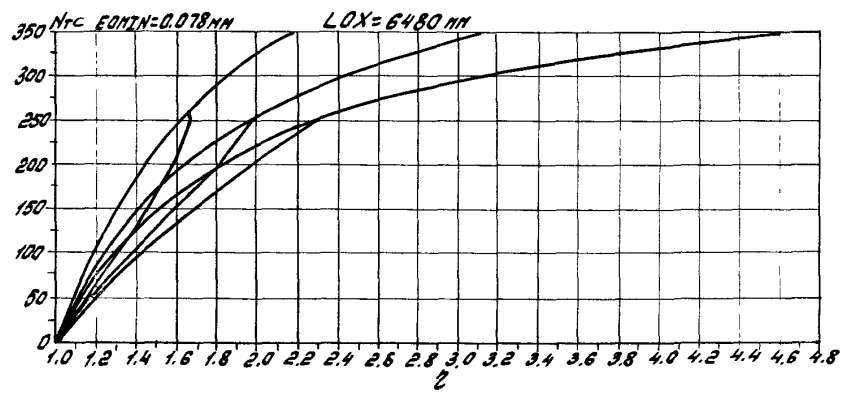
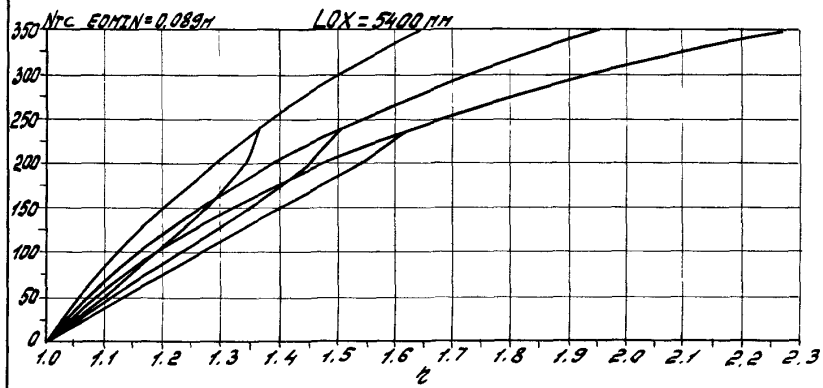

Шаб. N. мод. 1. Подпись и дата. Измер. ш. 6. N

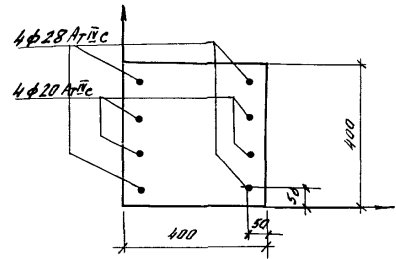
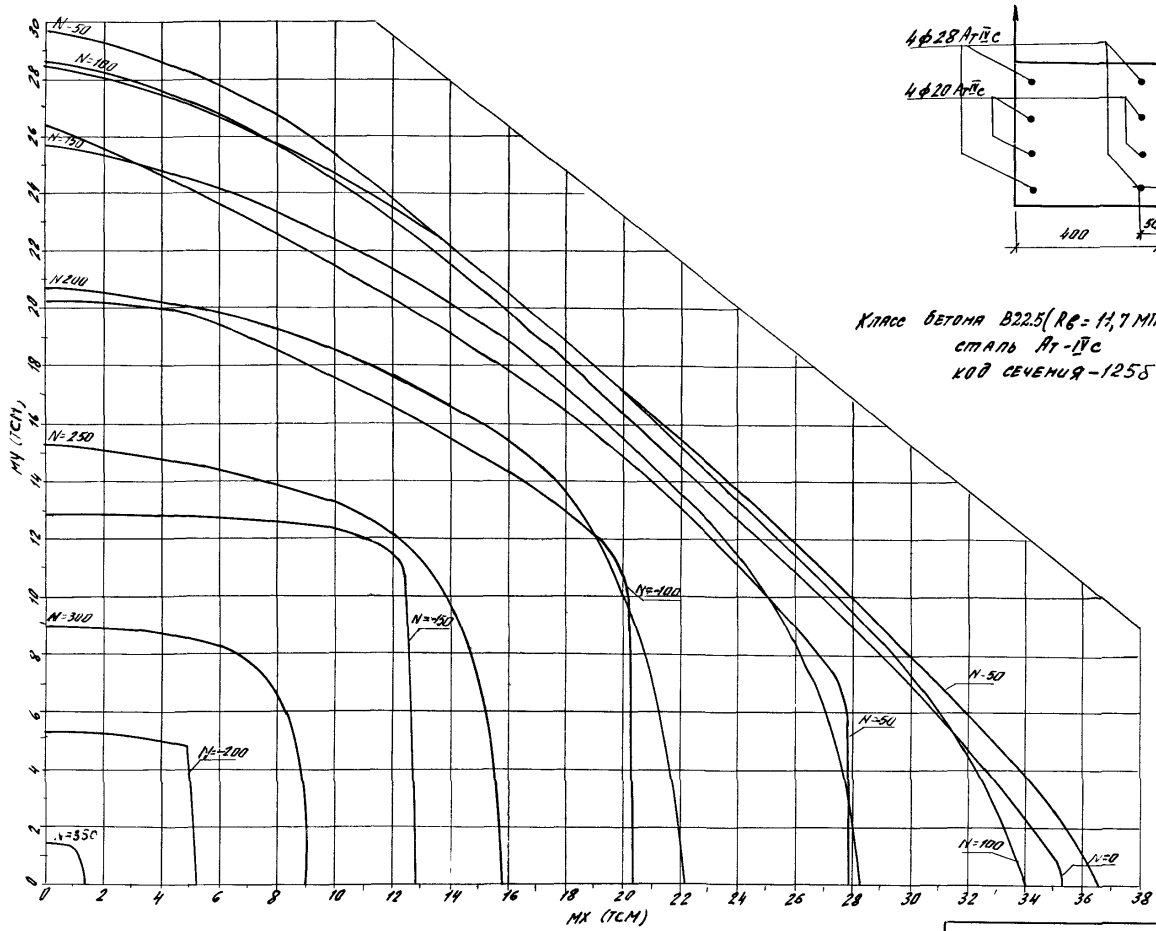

Класс бетона В22.5 ($R_b = 17,7$ МПа при учете $\gamma_{b2} = 0,90$)
 сталь А-I-C
 КДБ сечения - 1258

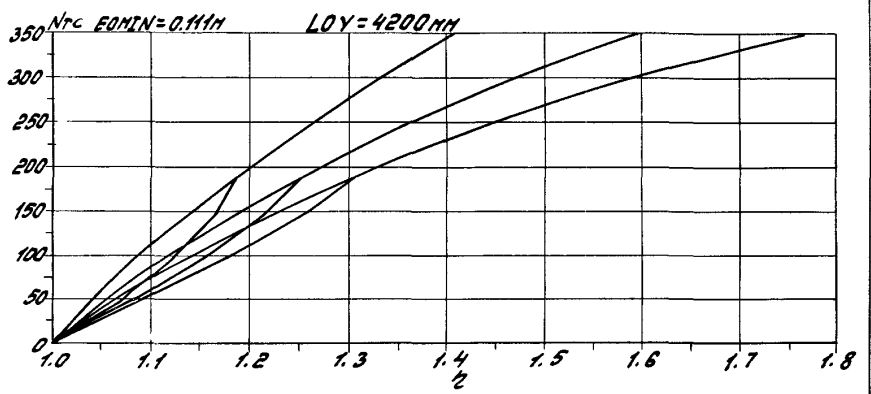
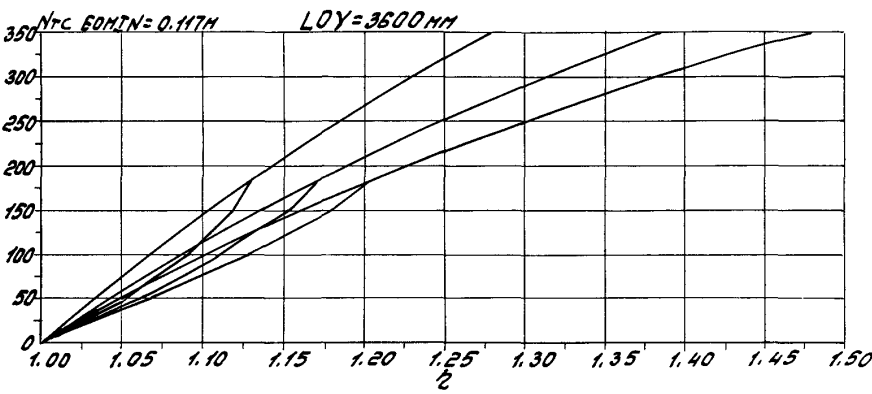
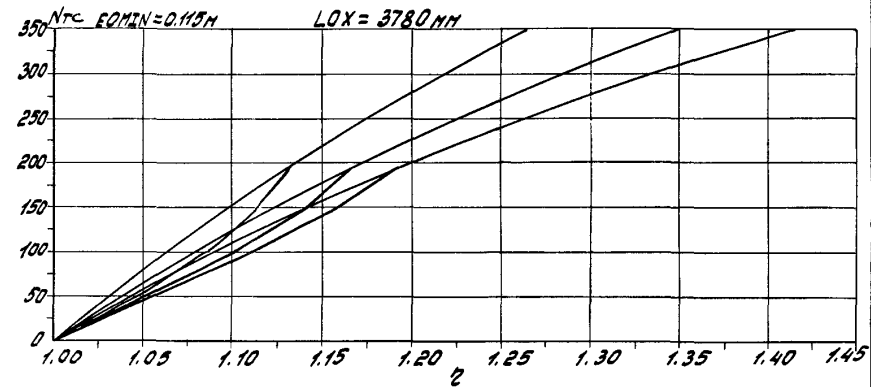
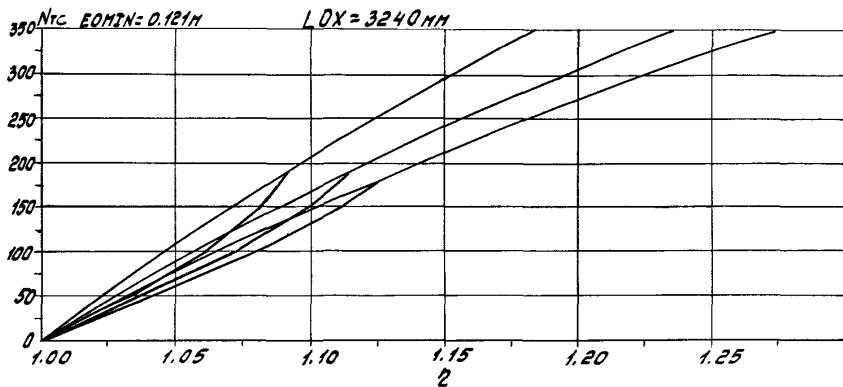

1.020.1-4 0-9 002

1.020.1-4 0-9 002	198
-------------------	-----

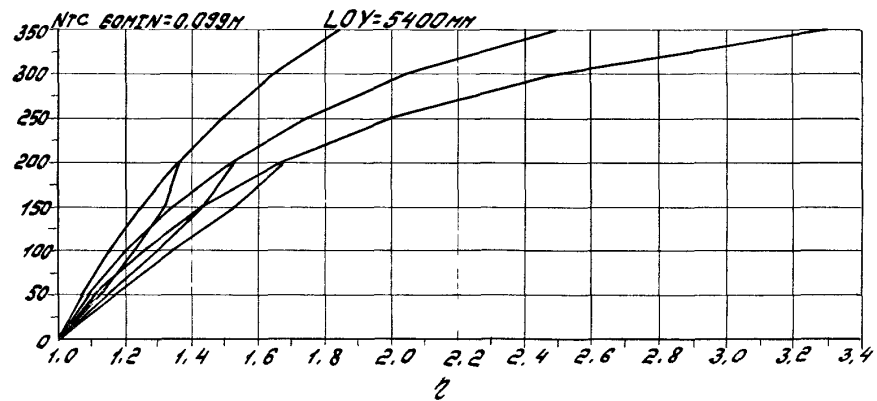
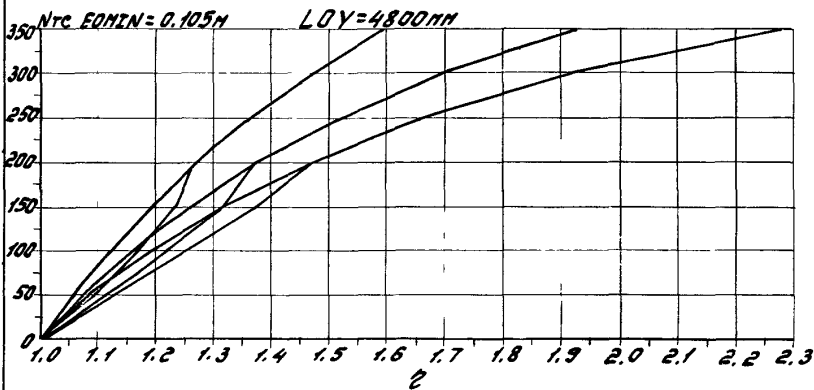
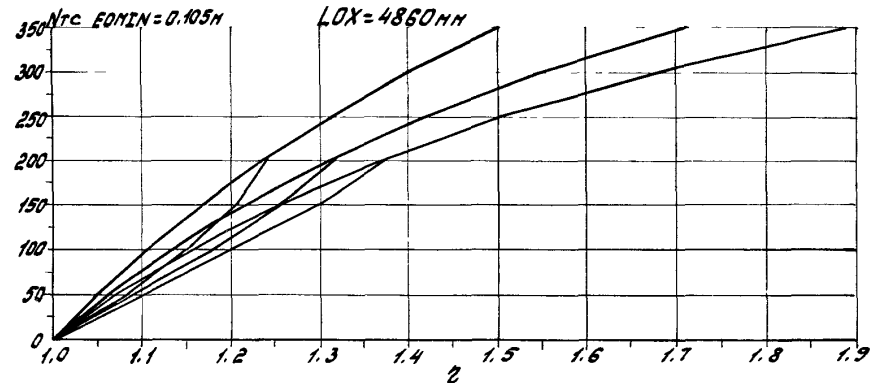
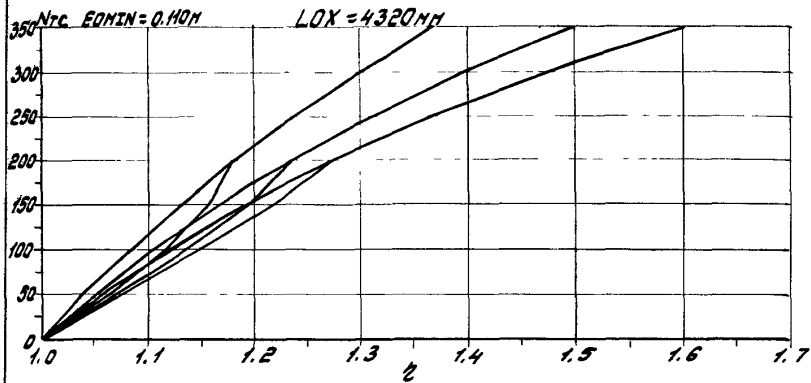

1.020.1-4 0-9 002

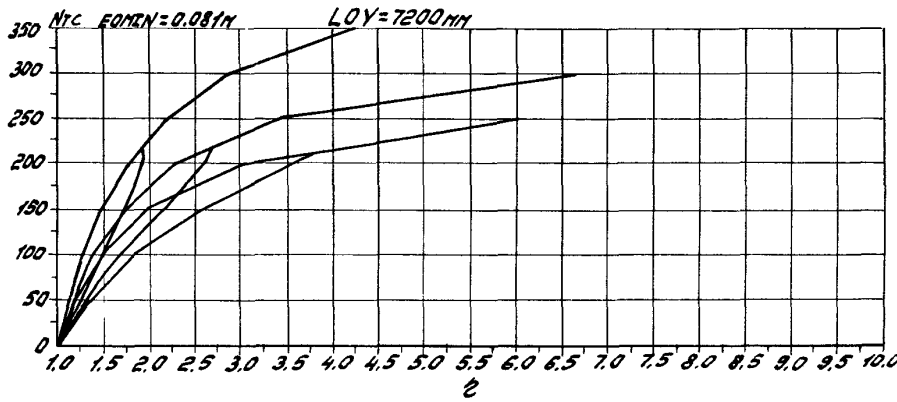
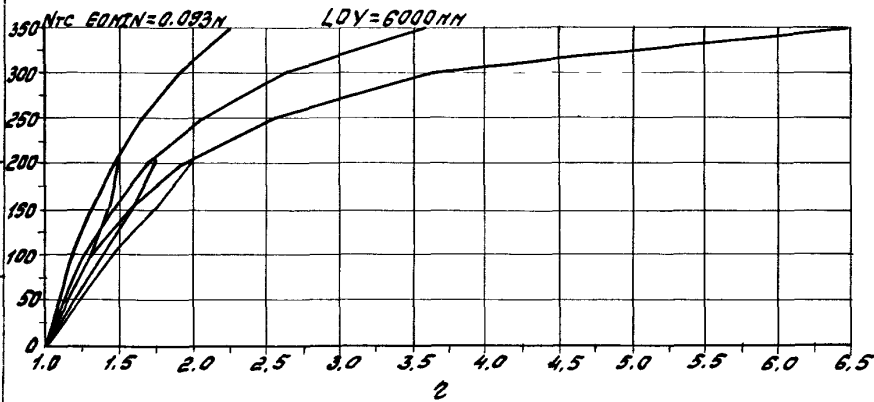
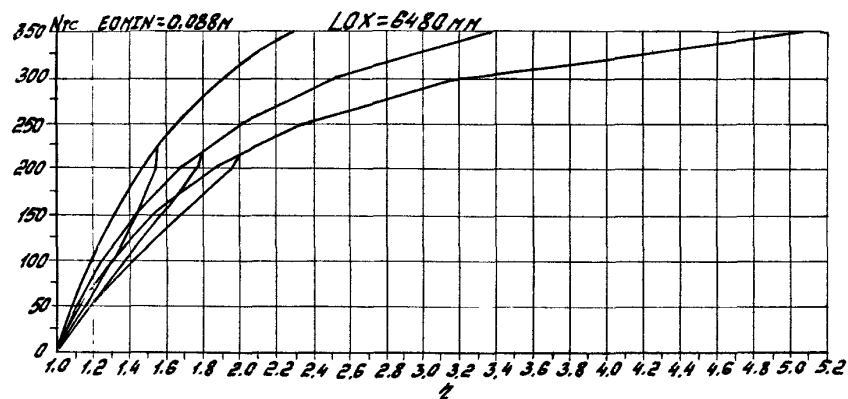
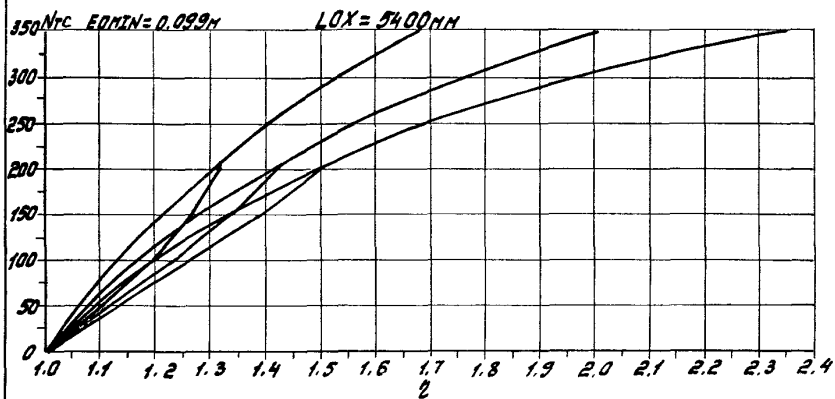

Nrc - Nrc, EOMIN - EOMIN, LOX - LOX, LOY - LOY

1.020.1-4 0-9 002 200

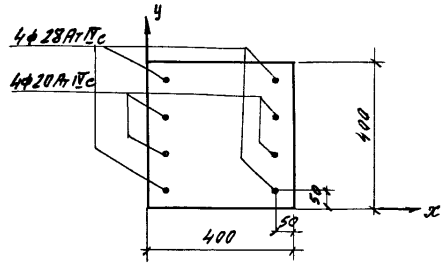
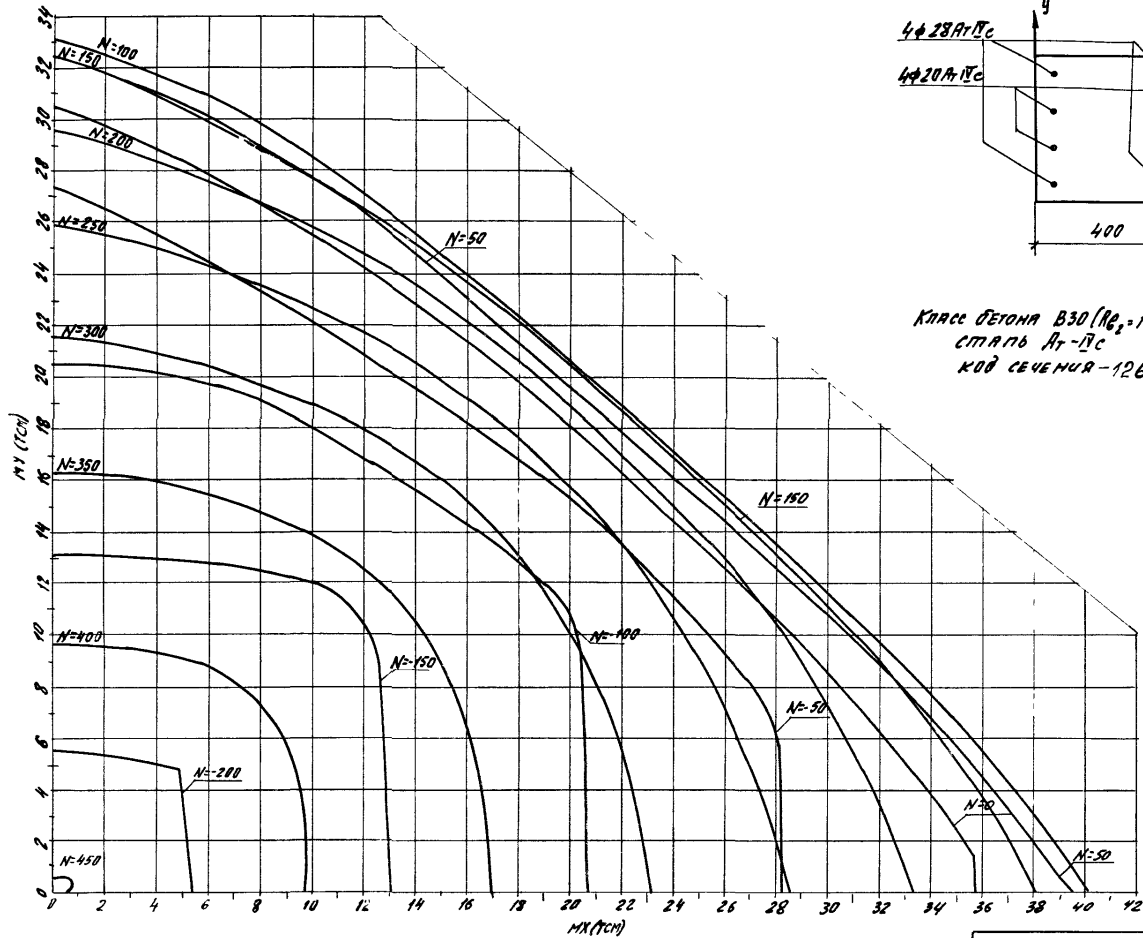

Класс бетона В30 ($R_b = 15,3$ при учете $\delta_{0,2} = 1,1$)
 сталь А1-11С
 код сечения - 126а

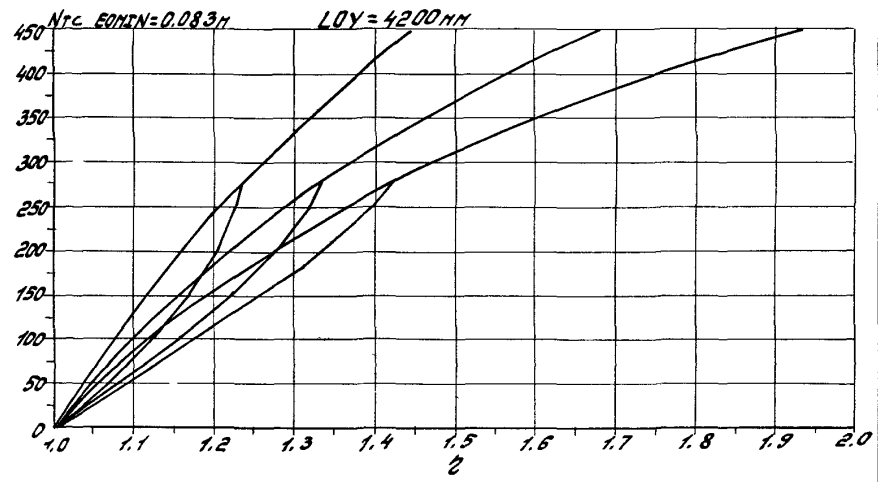
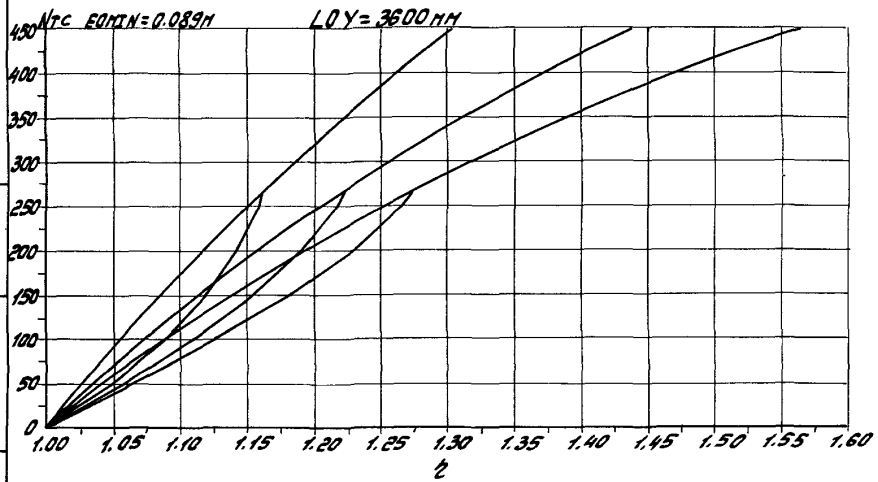
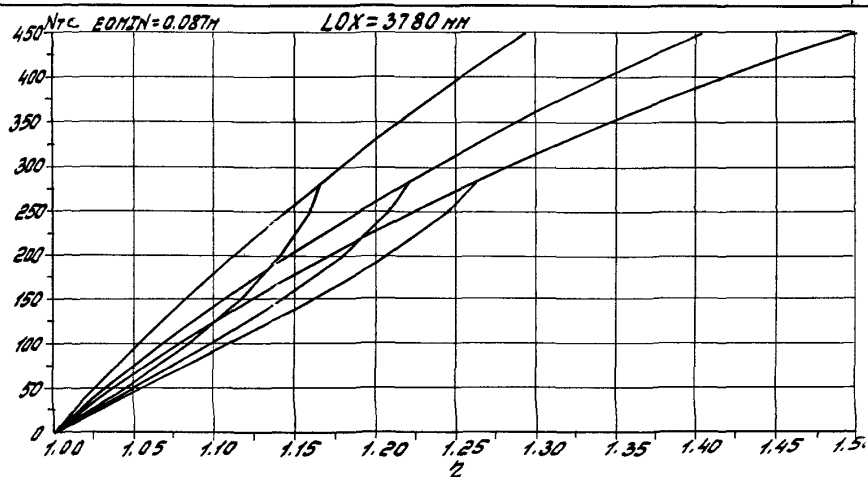
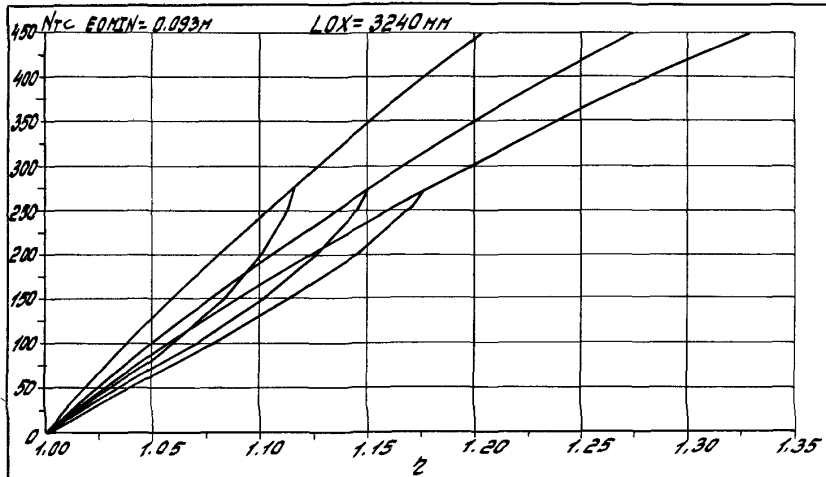

Кривые, вычисленные по формуле (3.3) при L=0.083H

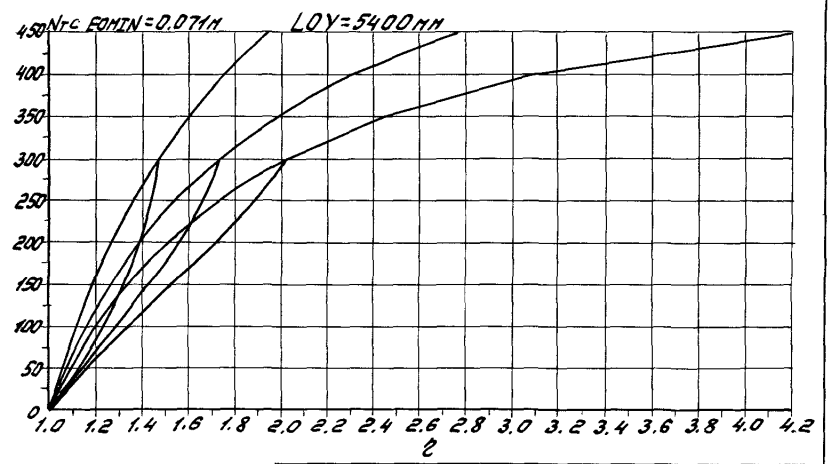
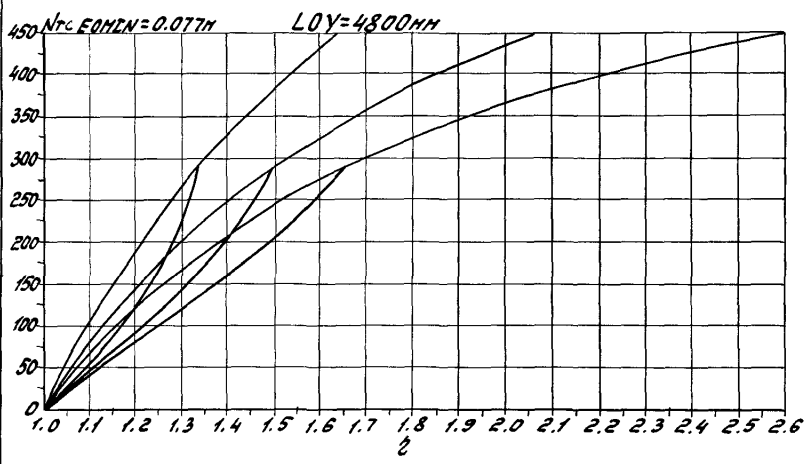
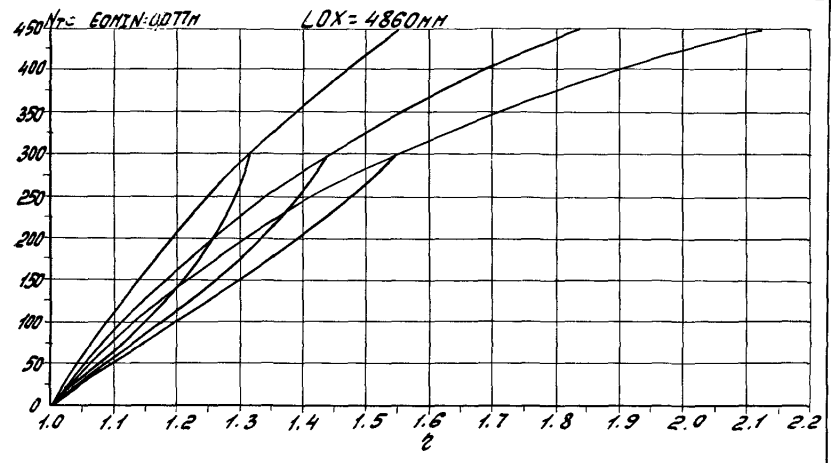
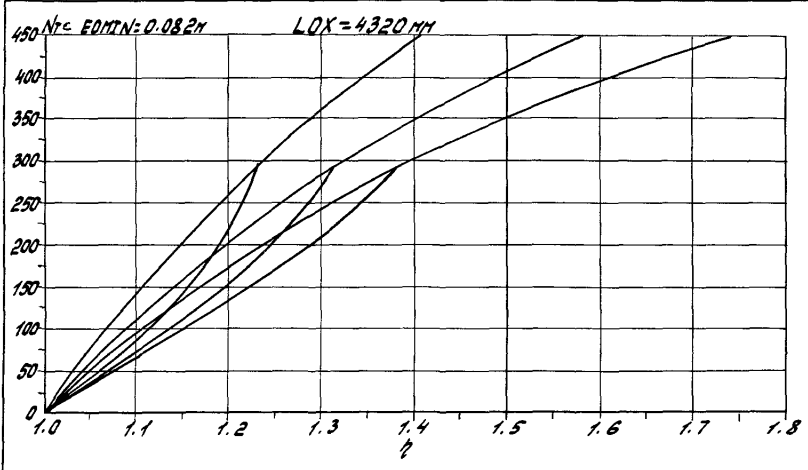

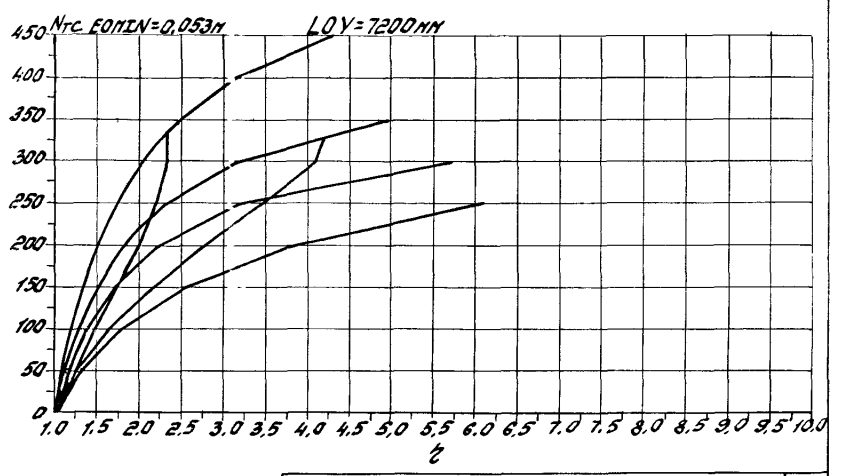
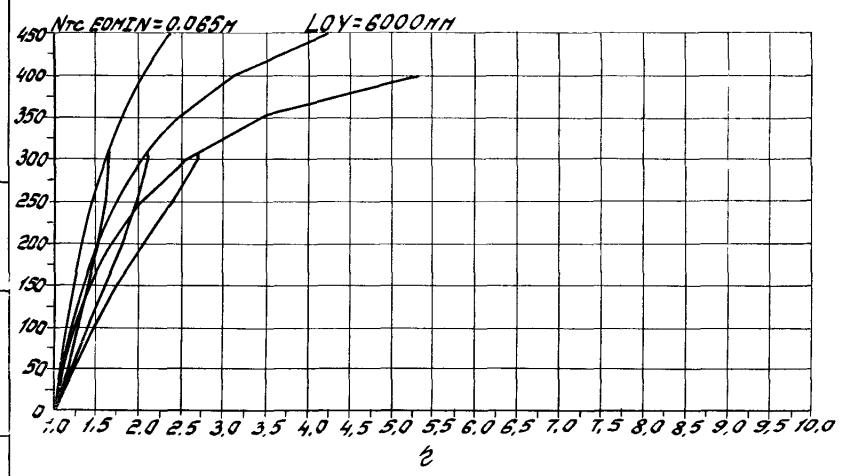
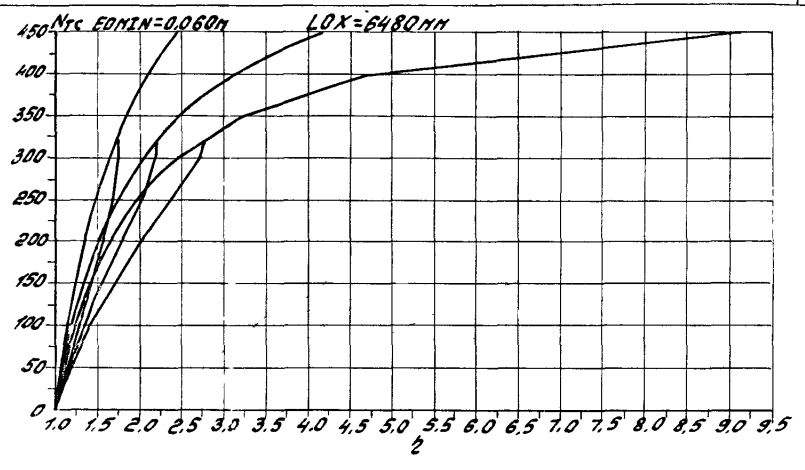
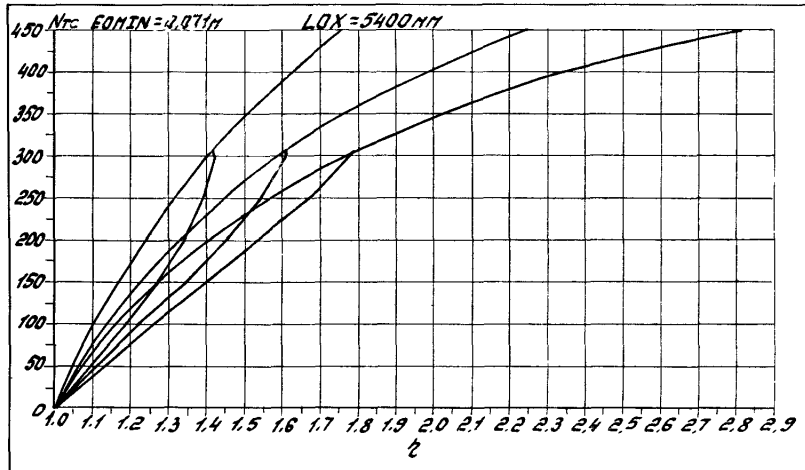

Unit: y-axis: *Nrc*; x-axis: z

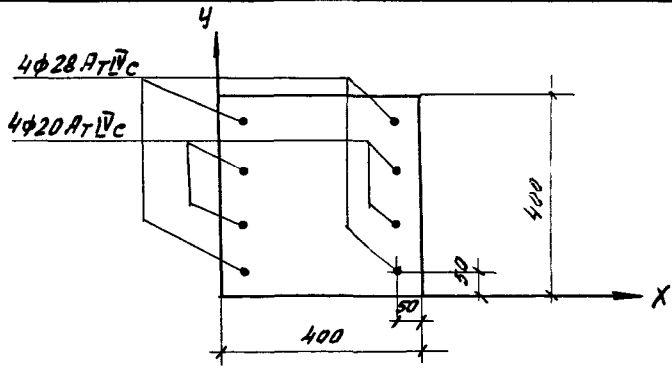
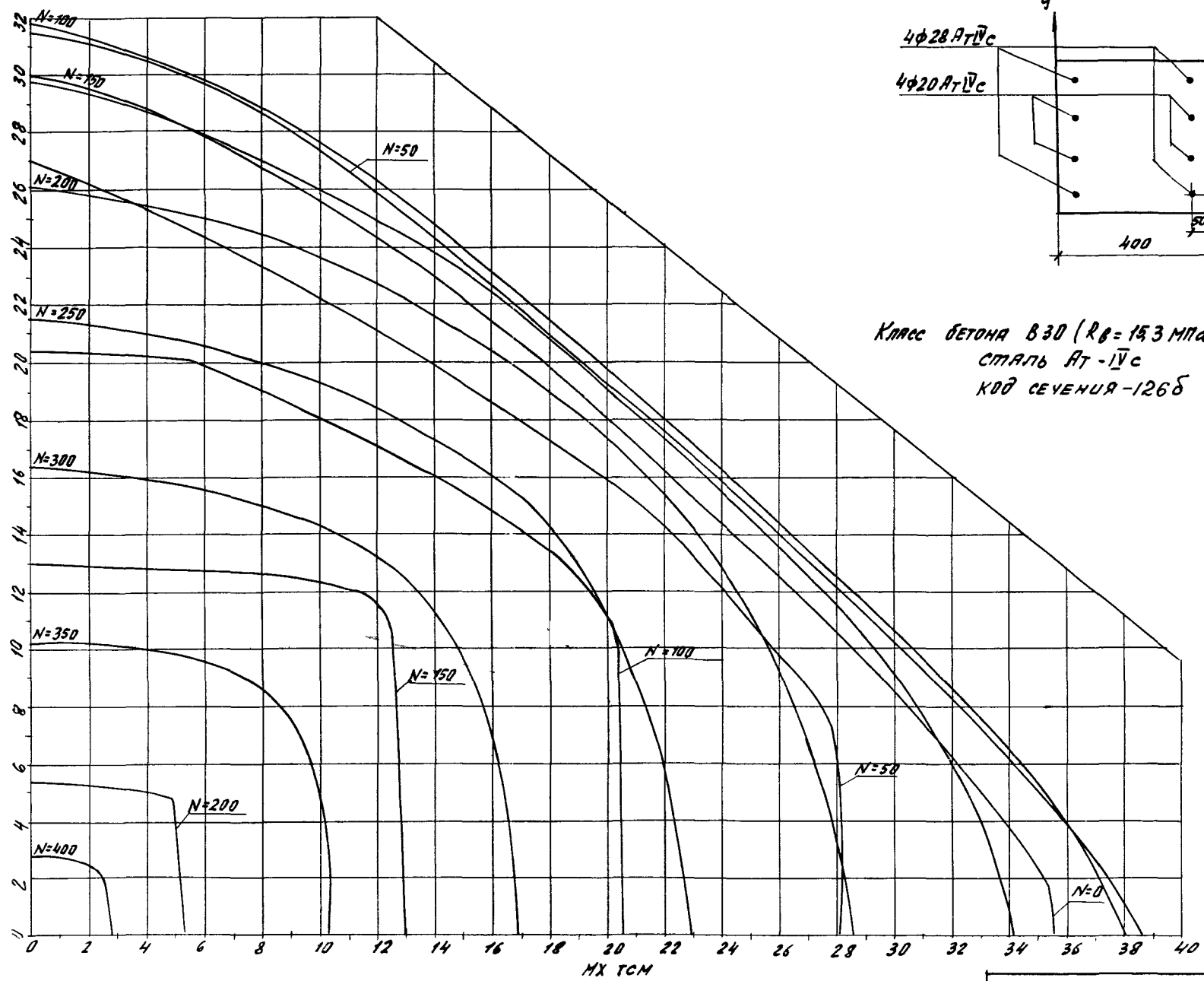

Класс бетона В30 ($R_b = 15.3$ МПа при учете $\gamma_{b2} = 0.90$)
 Сталь АТ-IVс
 Код сечения -126б

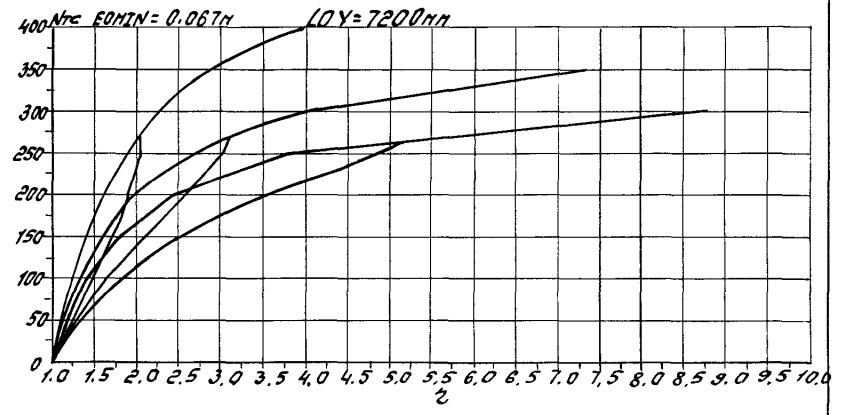
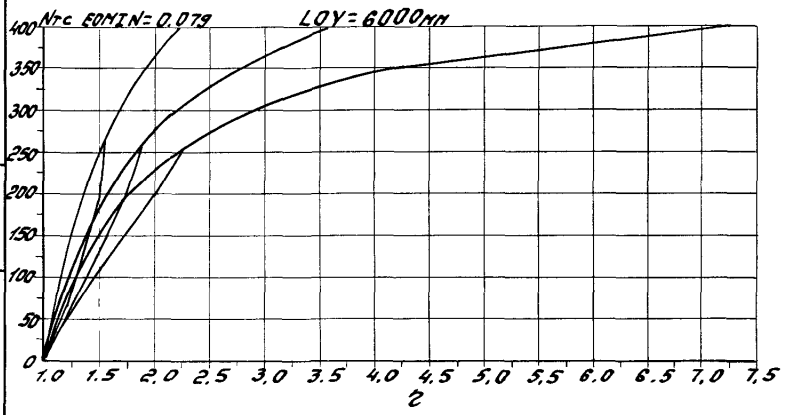
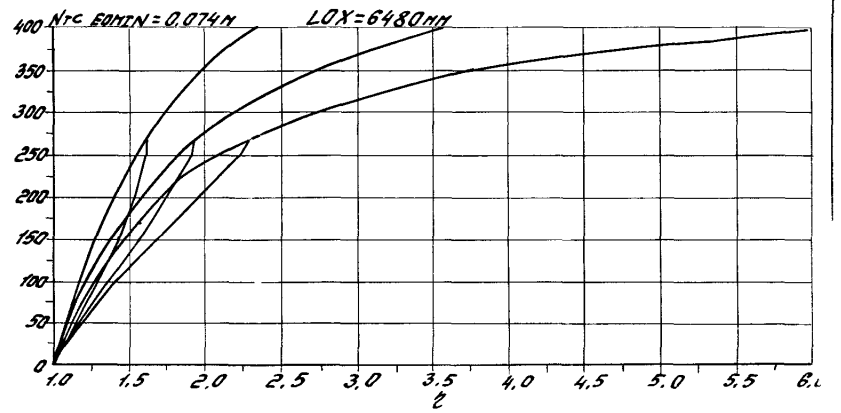
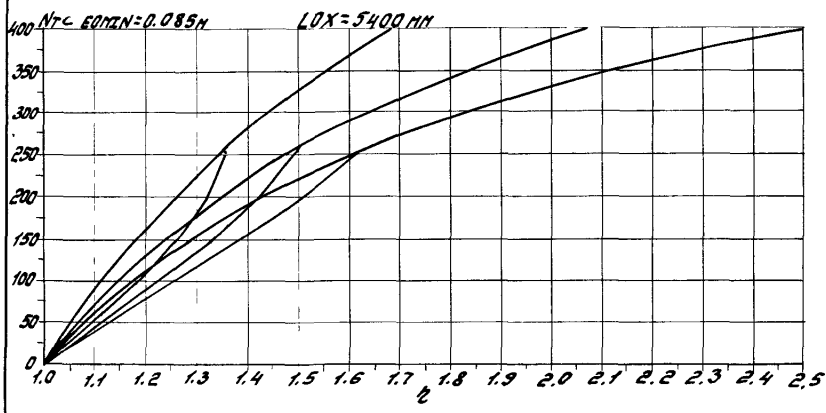

УМБ. N. 2002. УЧУНУСЪ У БАРУ БЭСОН УИГЭН

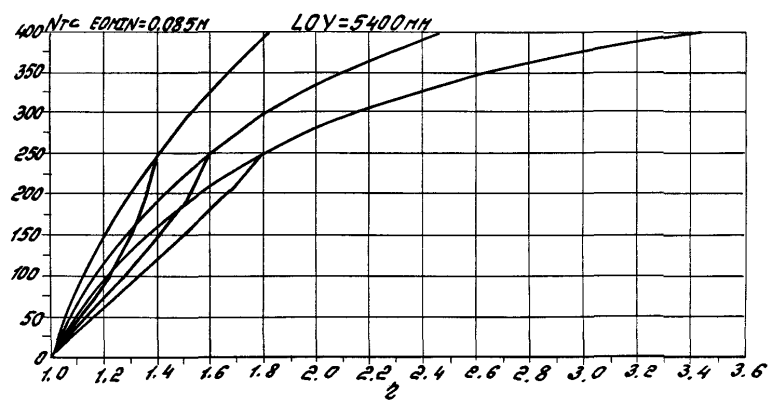
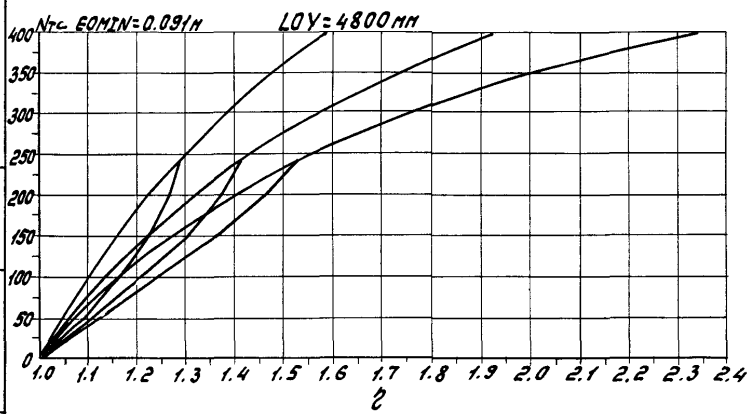
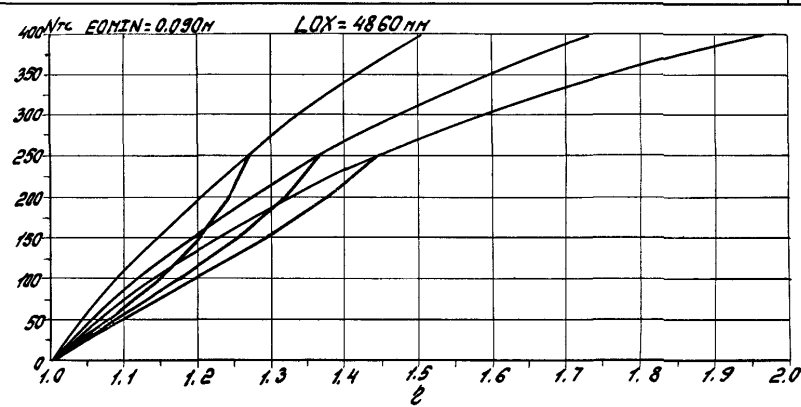
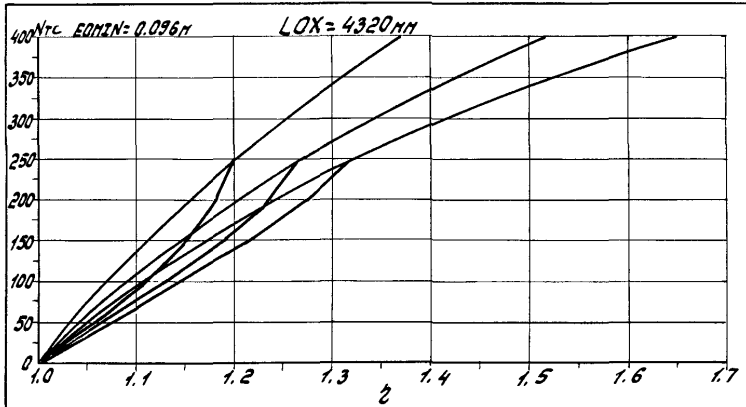

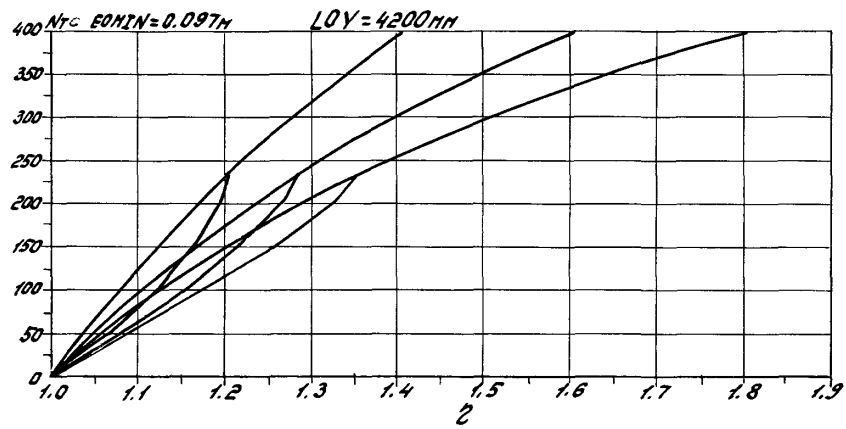
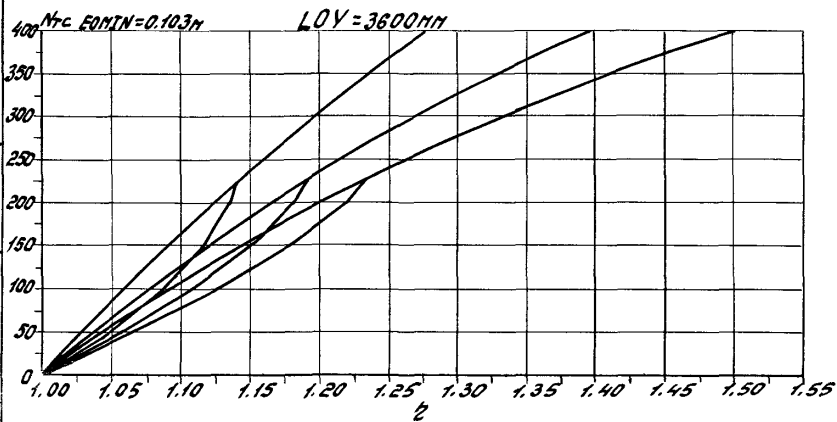
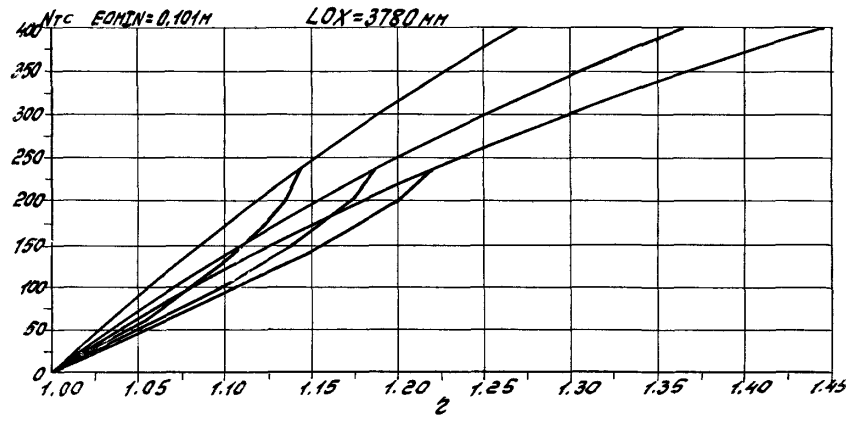
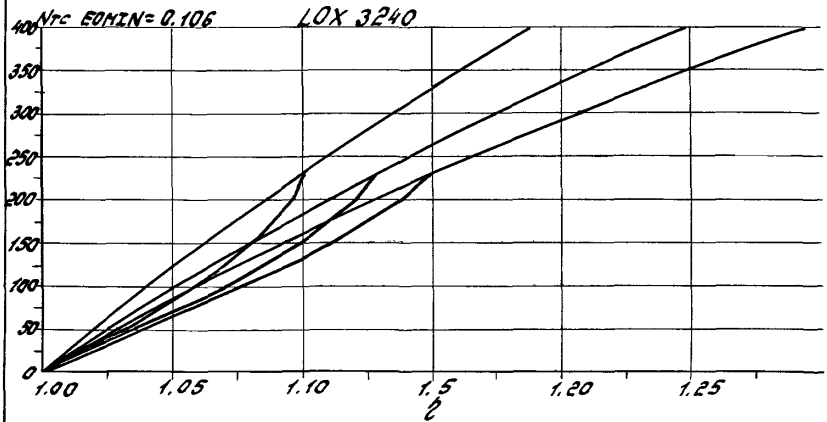

Уш.ч. N.1001. Подпись и печать стр. 016.11

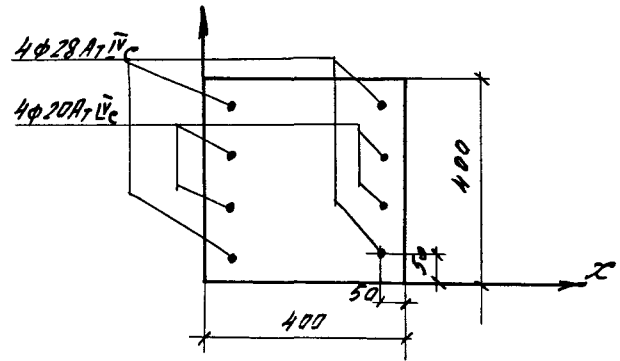
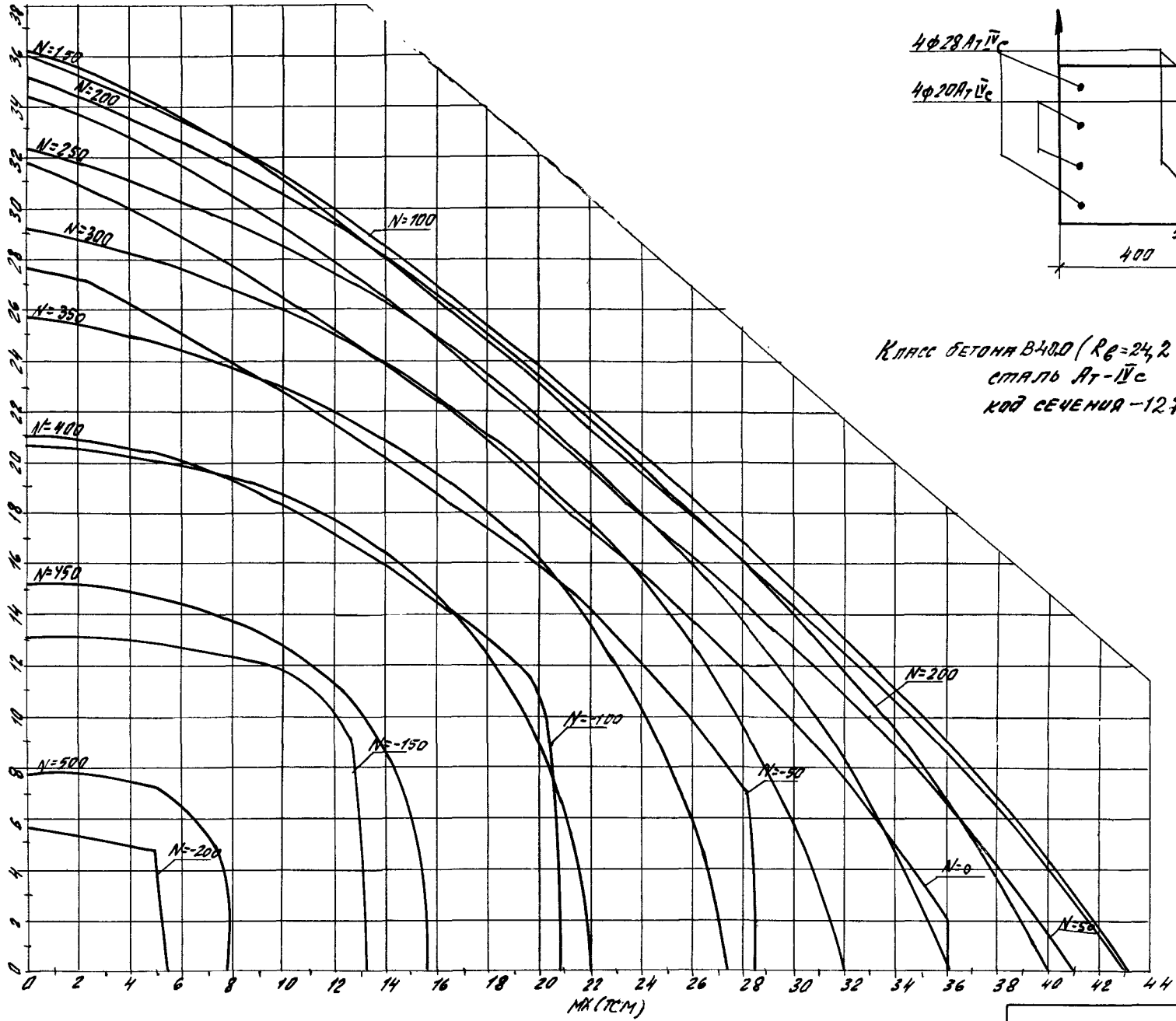

Класс бетона В40.0 ($R_b = 24.2$ МПа при учете $\gamma_{b2} = 1.10$)
 сталь А1-11с
 код сечения -127д

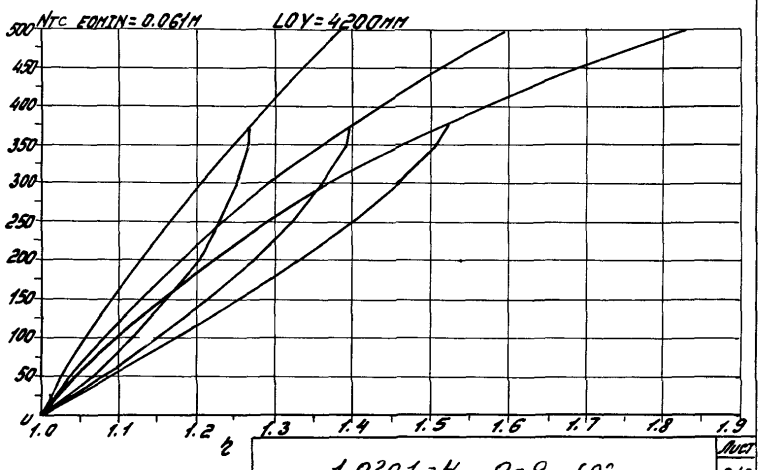
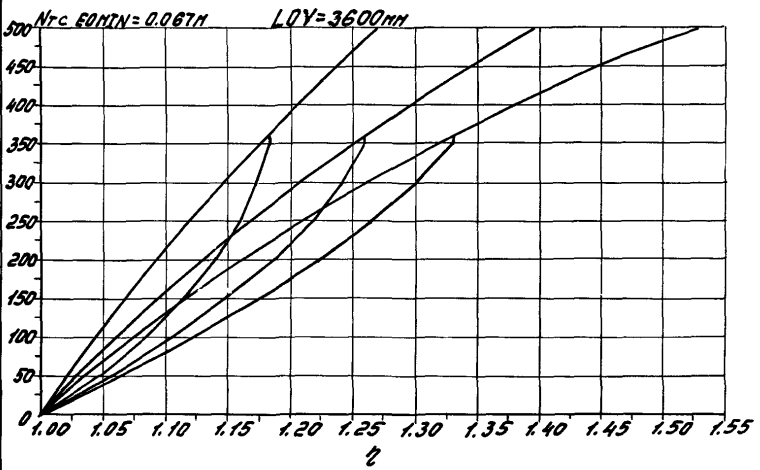
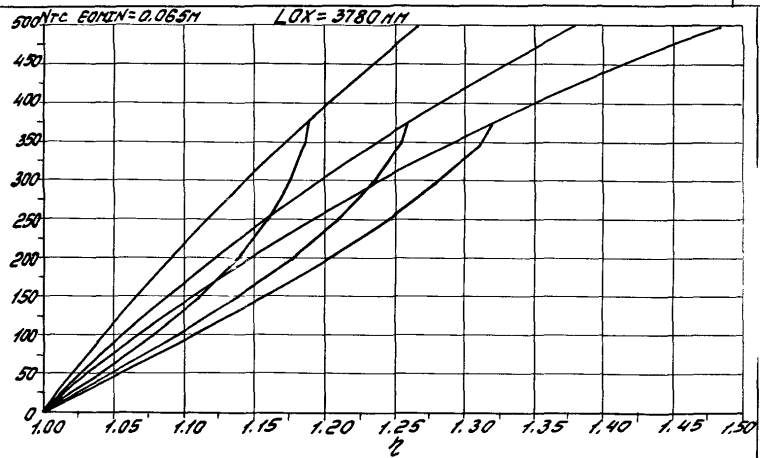
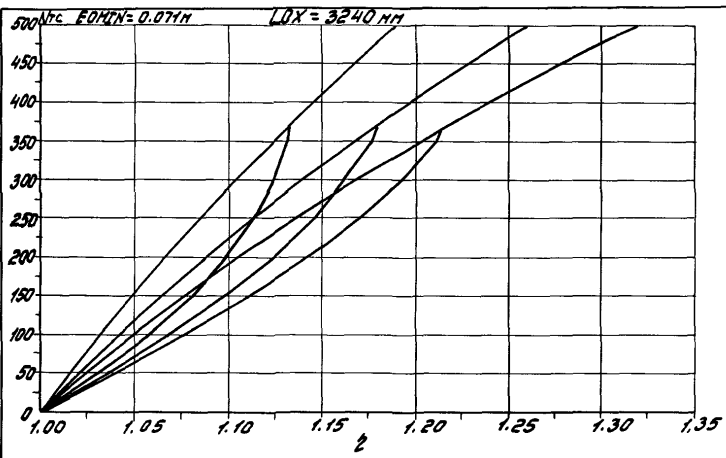

1.0201-4 0-9 102 Rect
210

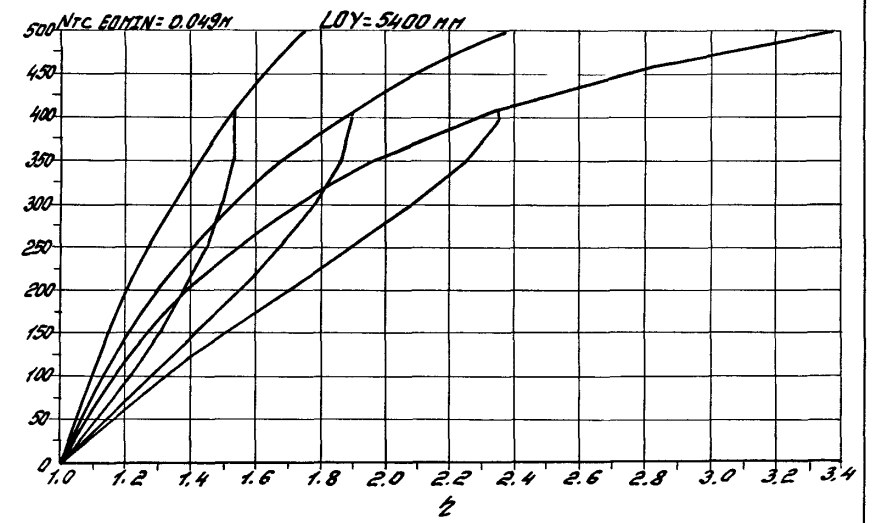
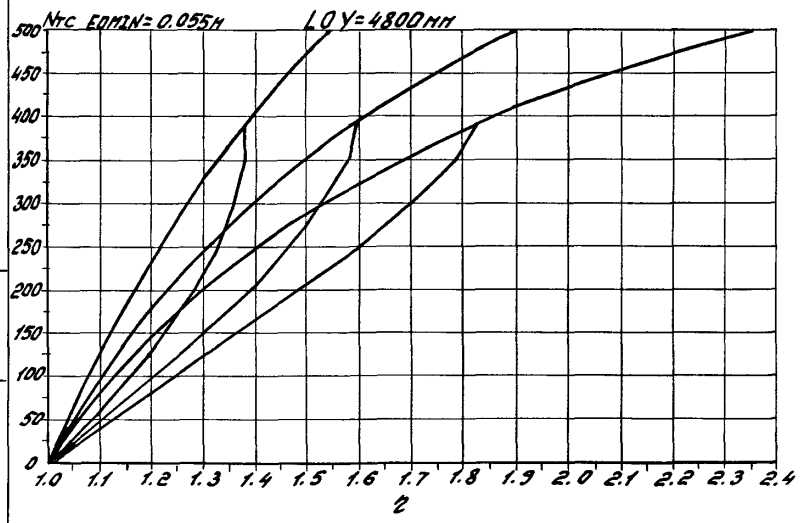
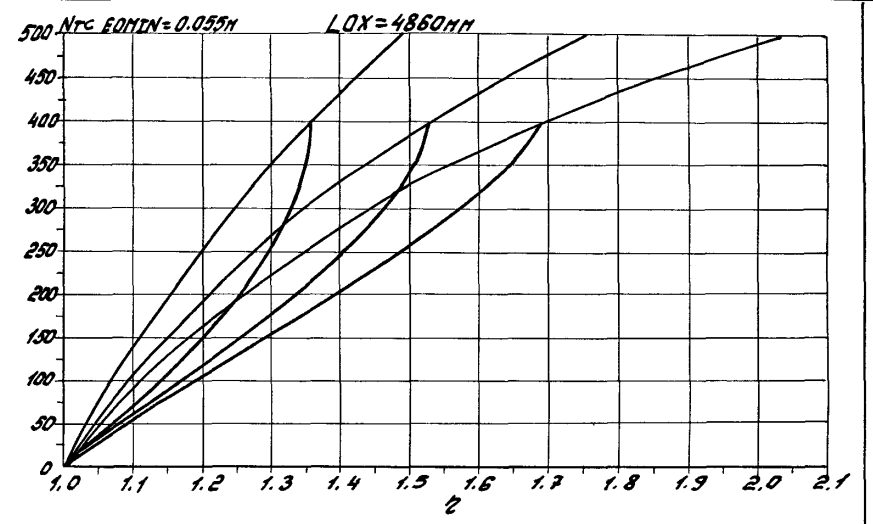
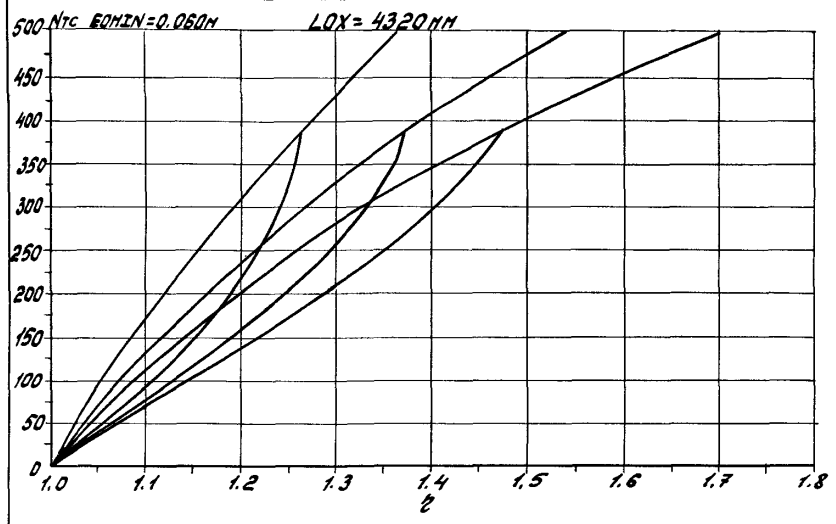

Учб. изд. ВИАВ. Москва. 1957. 100 стр.

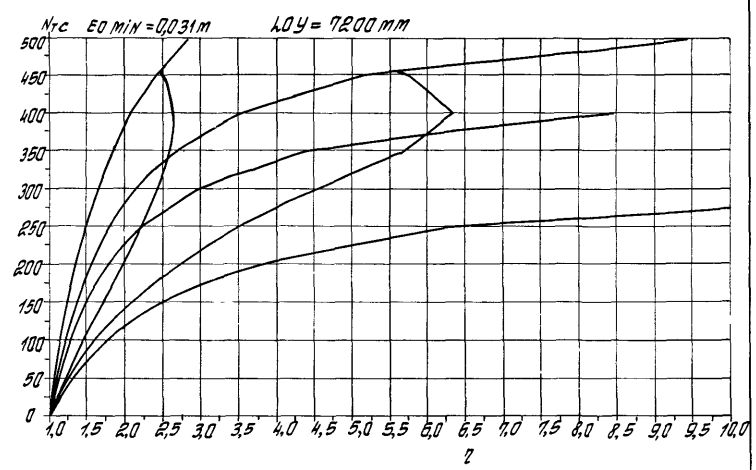
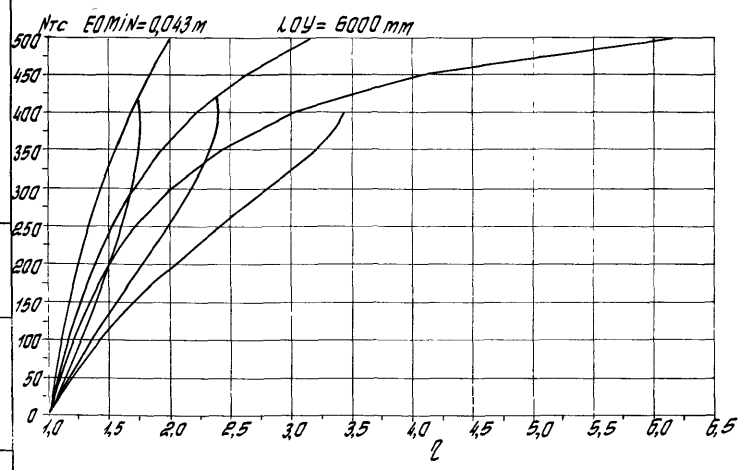
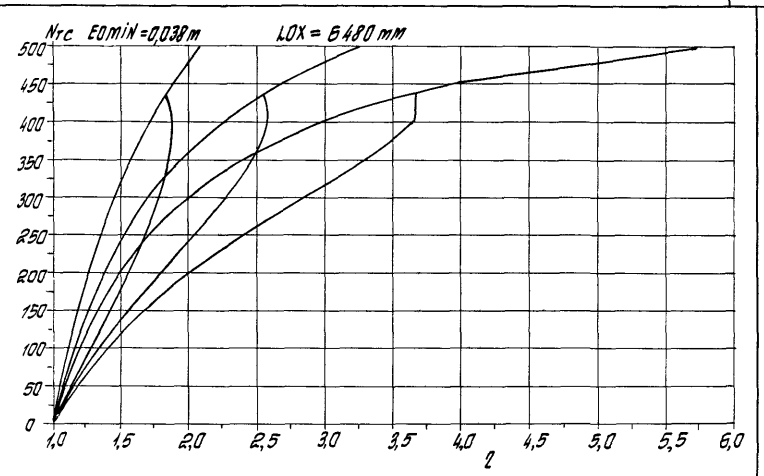
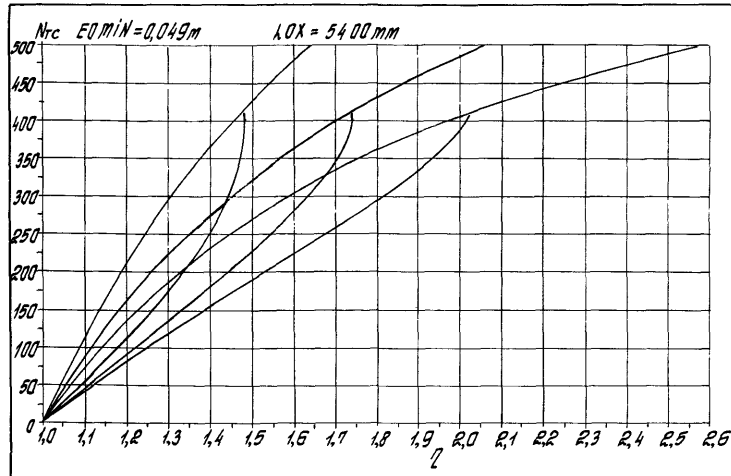

Лит. № 1000. Инв. № 1000. Л. 1000. 1000.

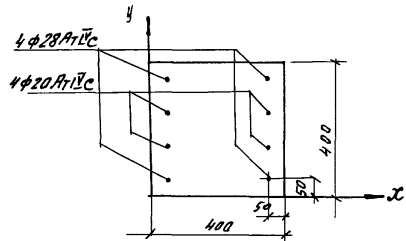
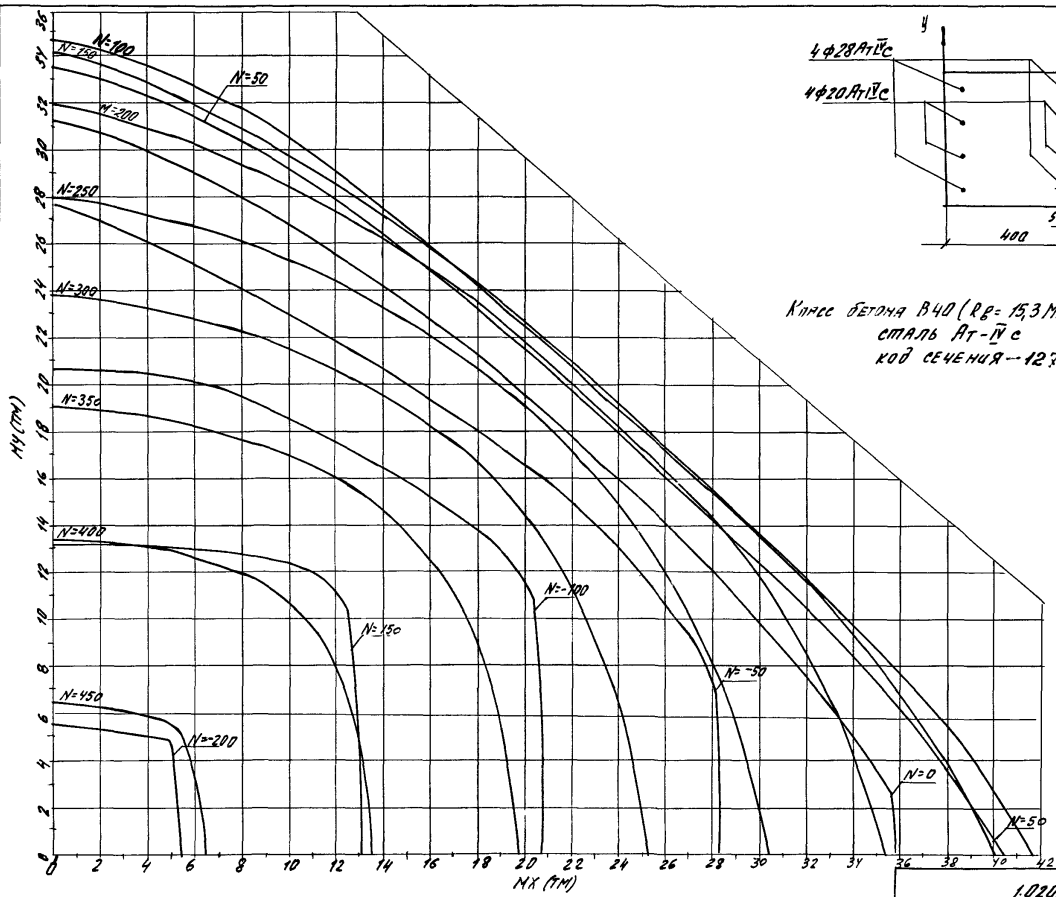

Класс бетона В40 ($R_B = 15,3 \text{ МПа}$ при учете $\gamma_{B2} = 0,90$)
 сталь Ат-II с
 код сечения -- 1275

12 Nk max, Mmax, Pmax и др. Вспомогат. табл.

1.020.1-4 0-9 002

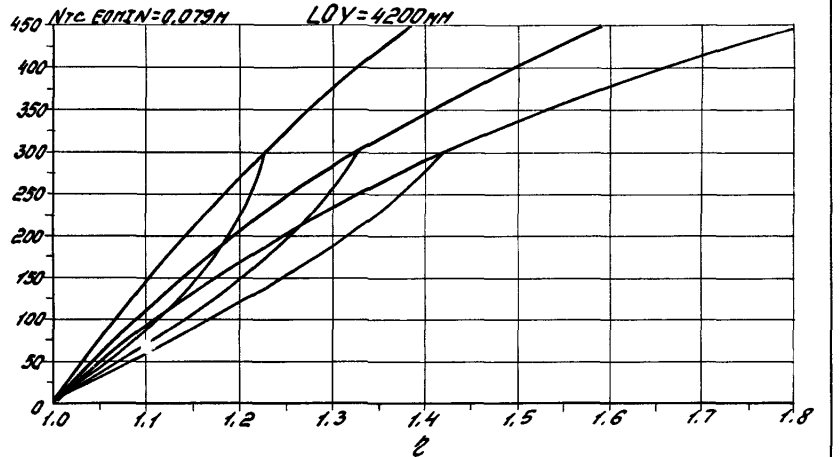
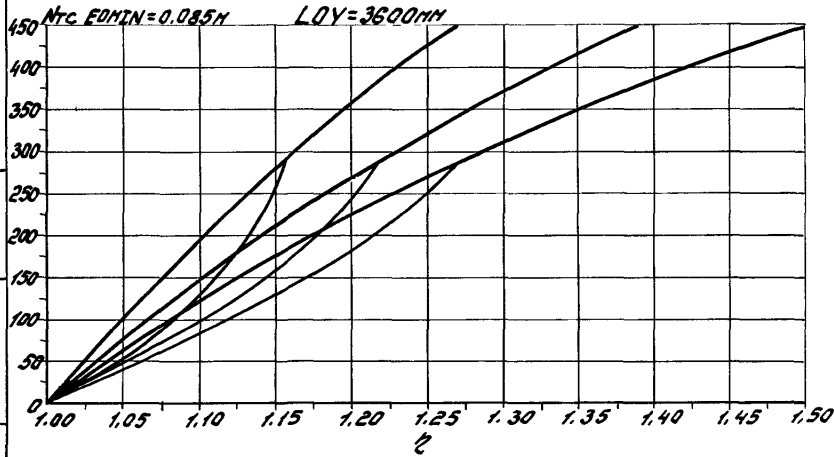
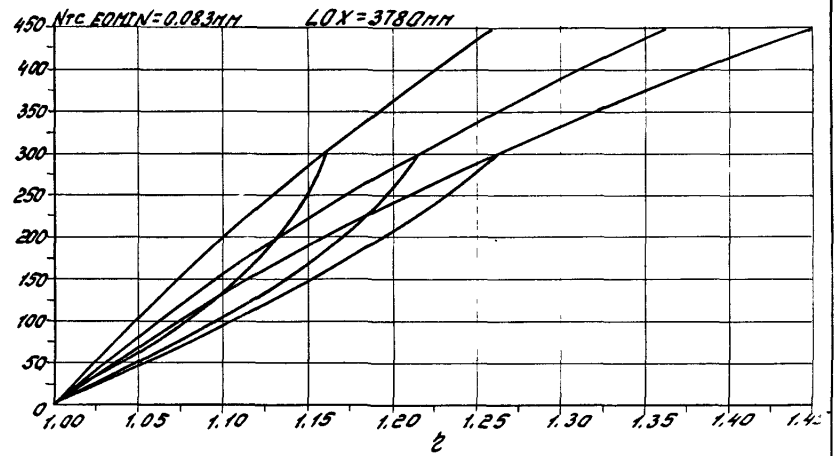
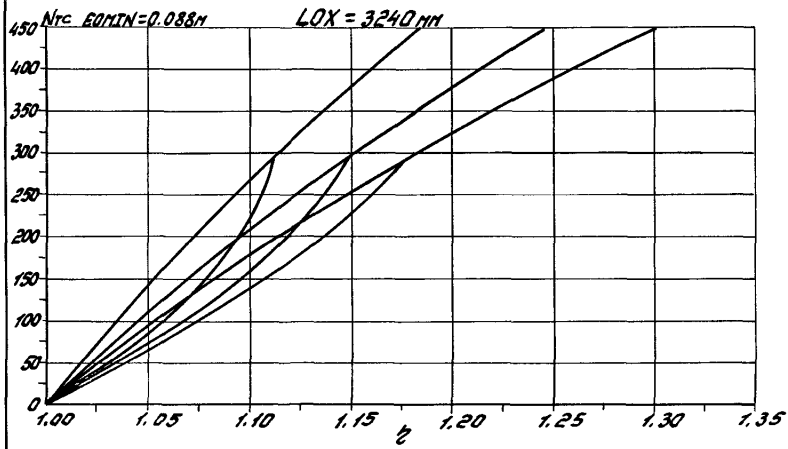

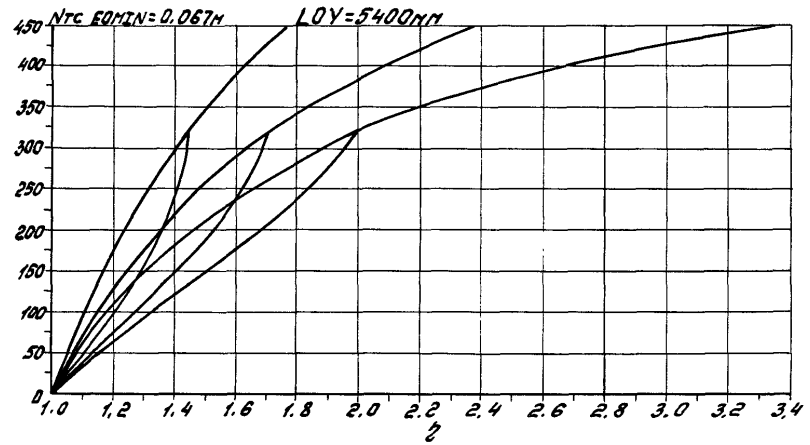
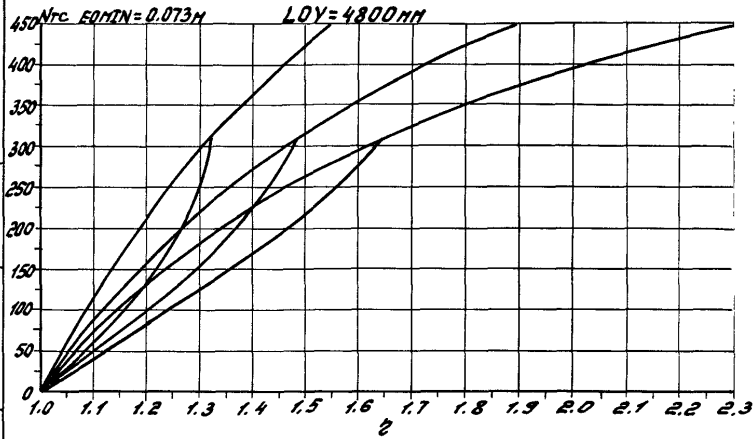
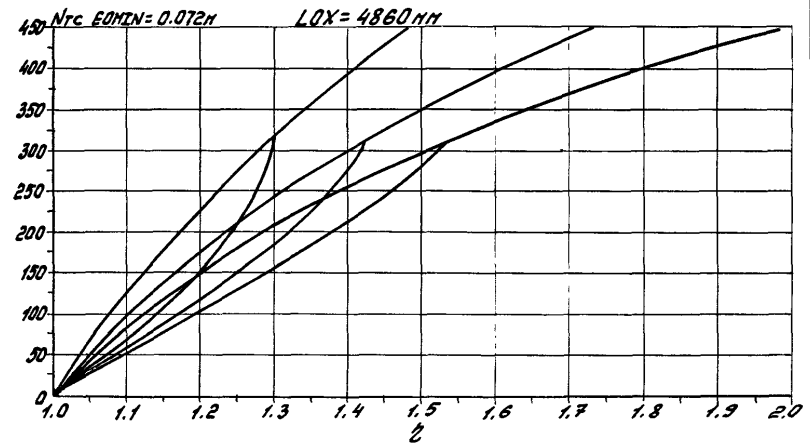
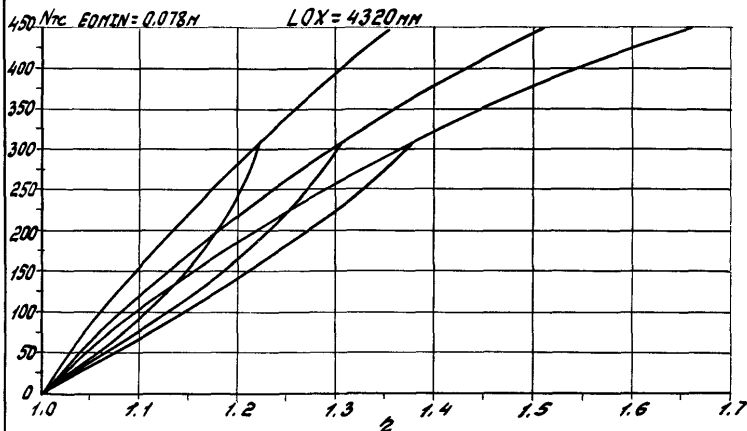

Дат. вводи. "число года" "время года"

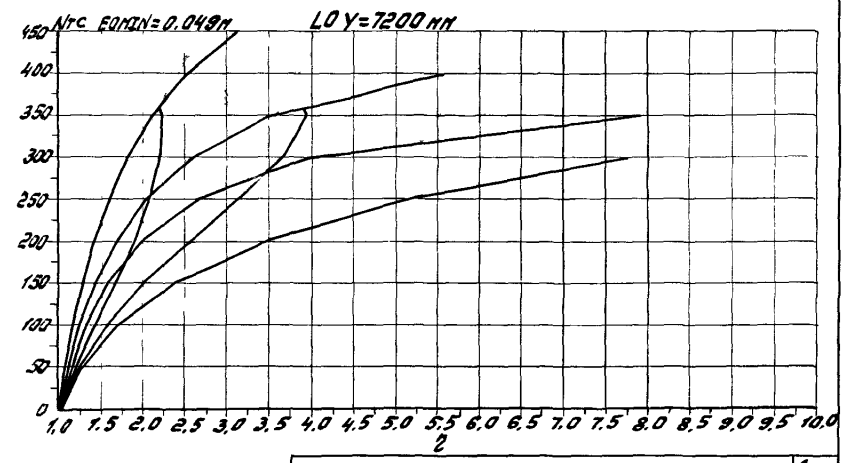
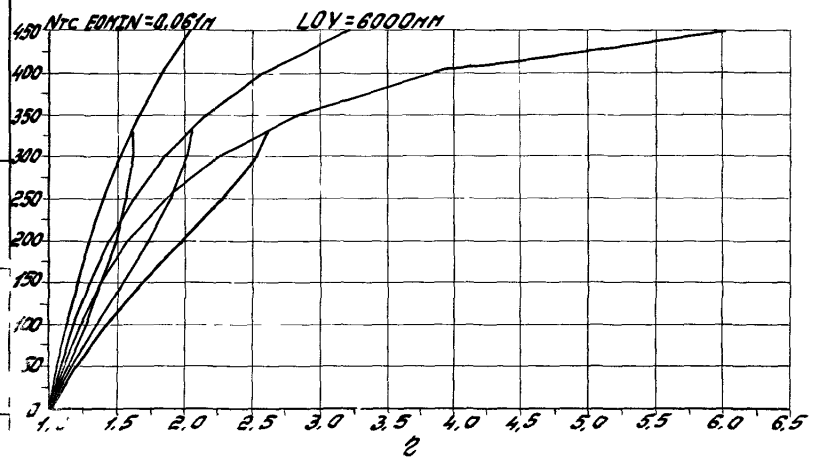
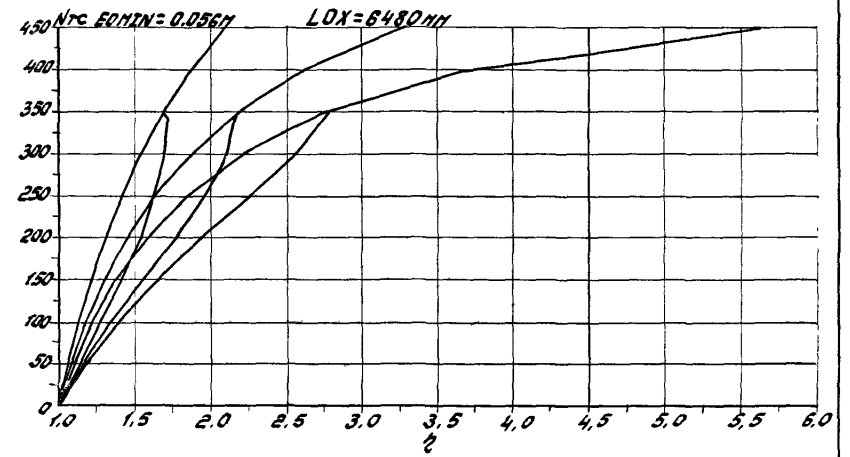
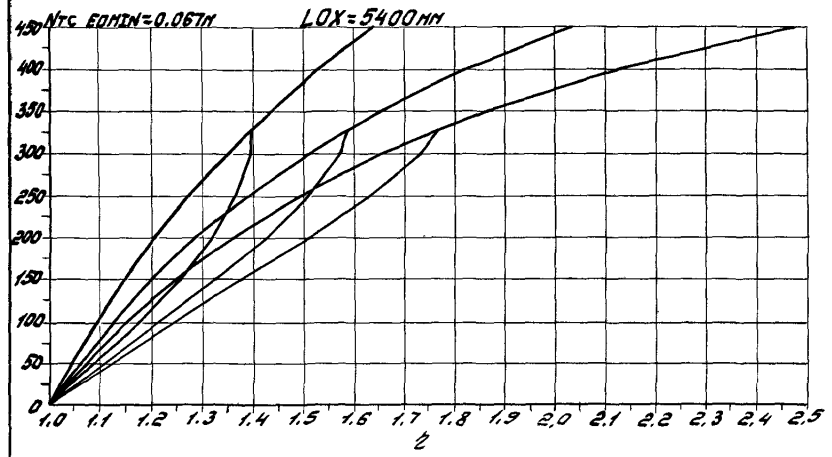

Угол наклона (в градусах) к горизонтальной оси

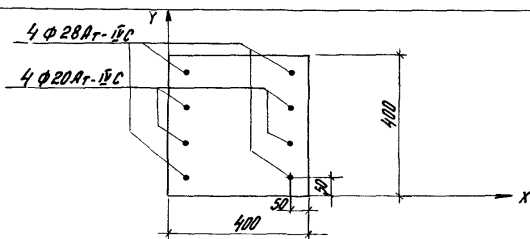
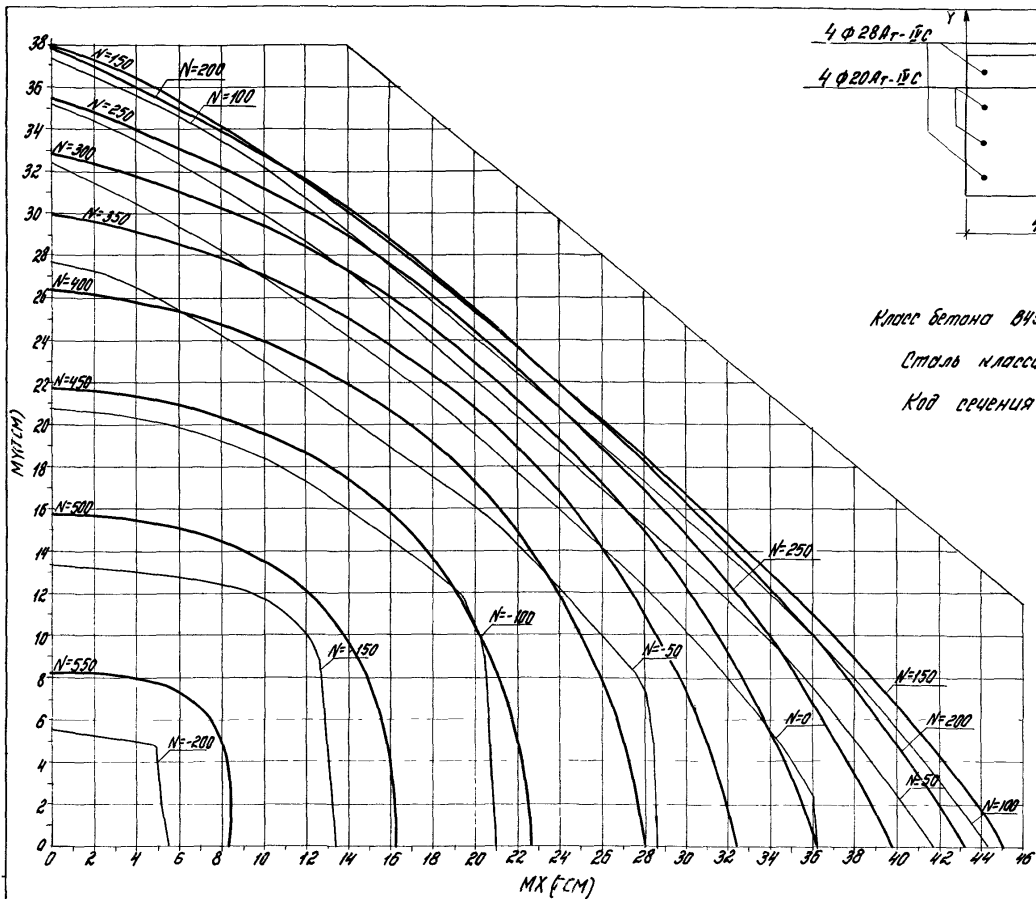

Класс бетона В450 ($R_b = 27,5 \text{ МПа}$ при учете $\gamma_{b2} = 1,10$)

Сталь класса Аг-IV

Код решения-128а

1.020.1-4 0-9 002

2007

217

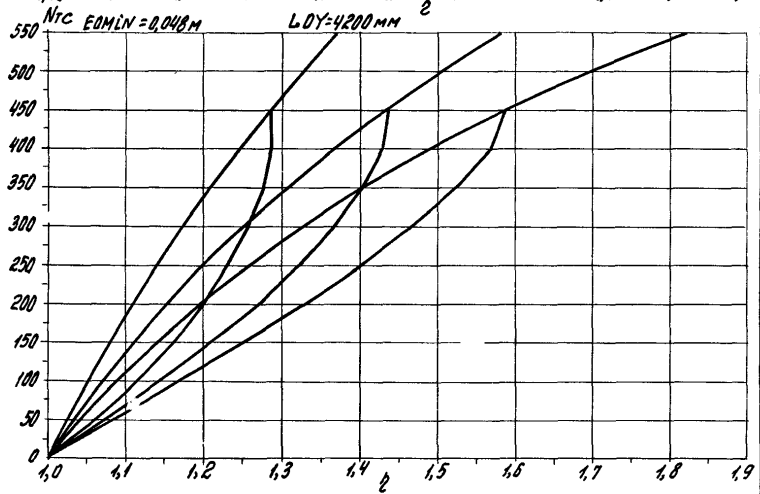
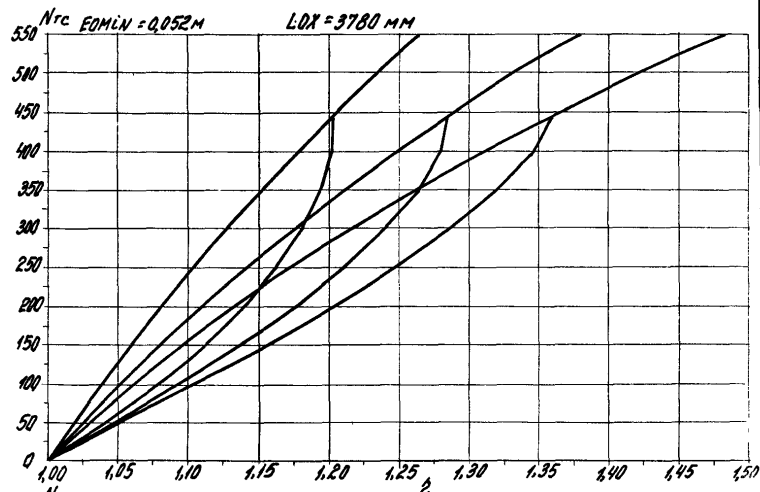
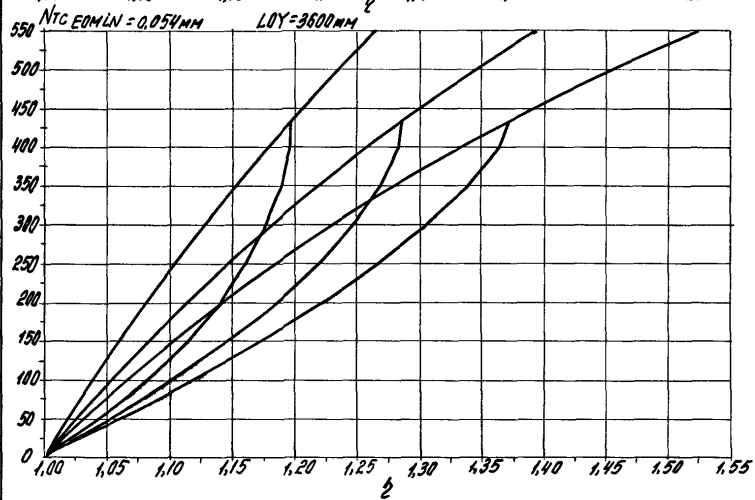
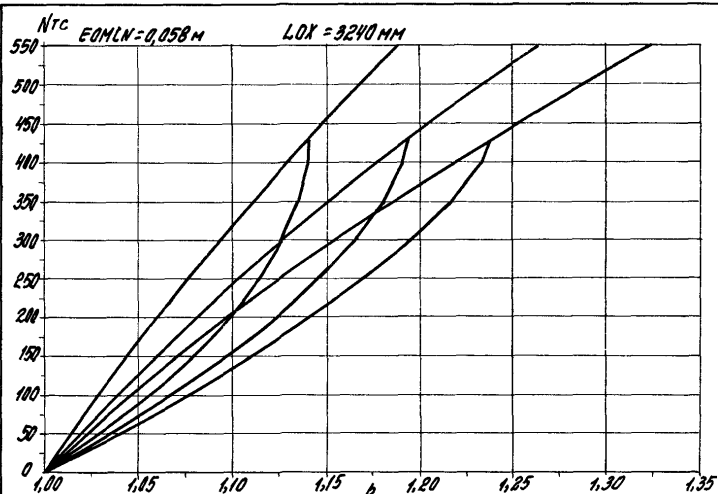

1.020.1-4 0-9 002

AVCT
218

LUBRIFICANTES Y OLEFINAS S.A. - CARRERA UNIV. 2124

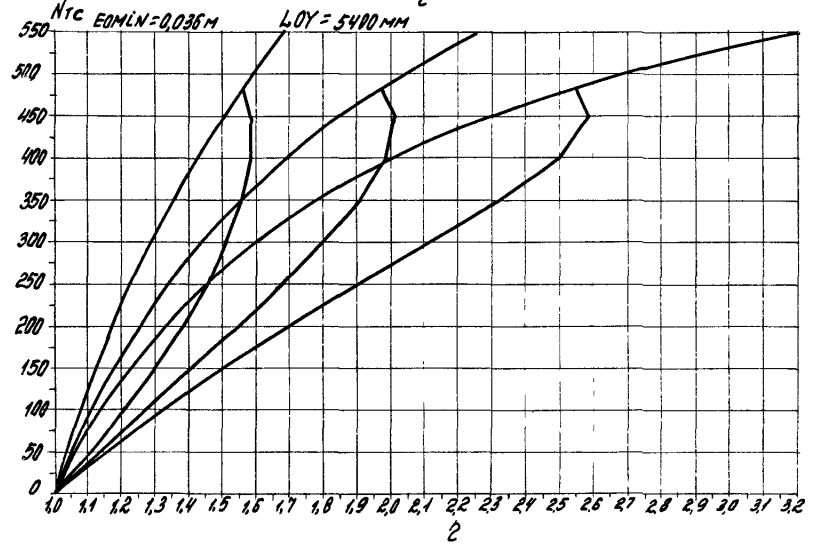
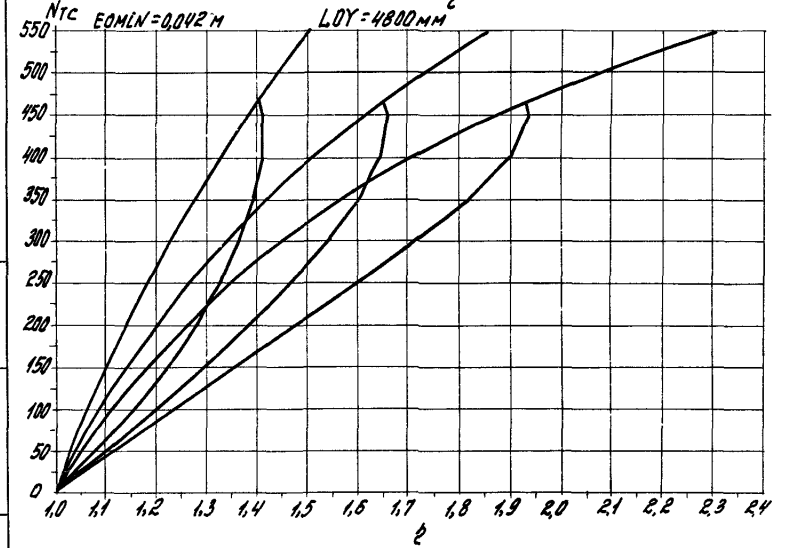
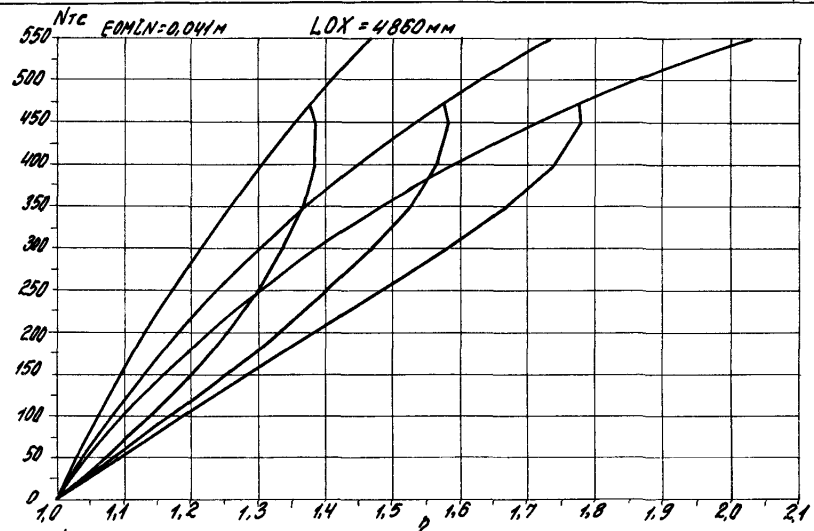
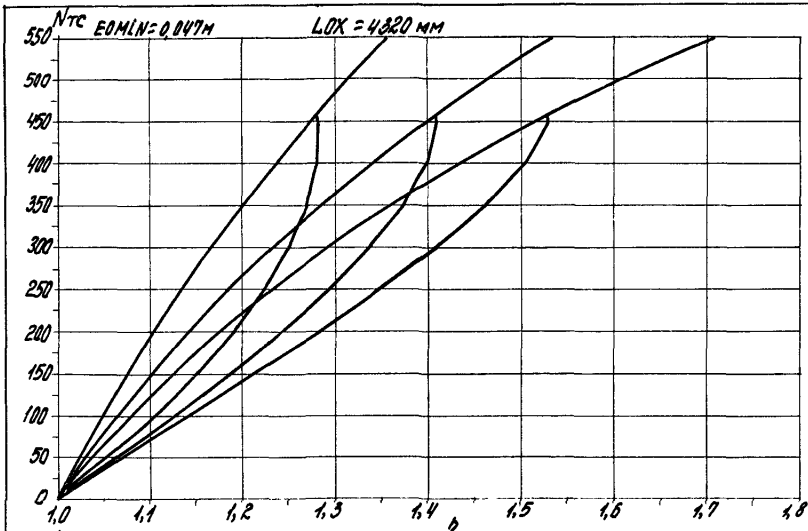

Zitat: Normal 2. (100 bis 6 mm) ...

1.020. 1-4 0-9 002 1/1000
219

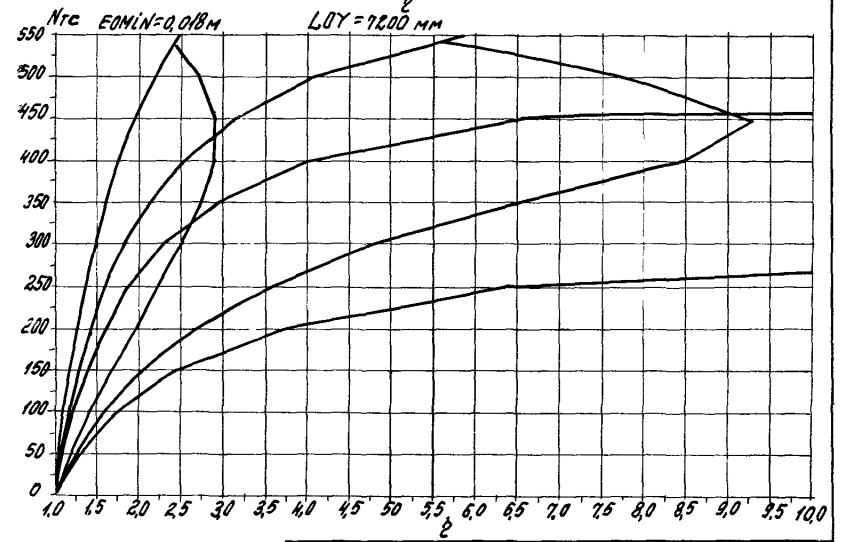
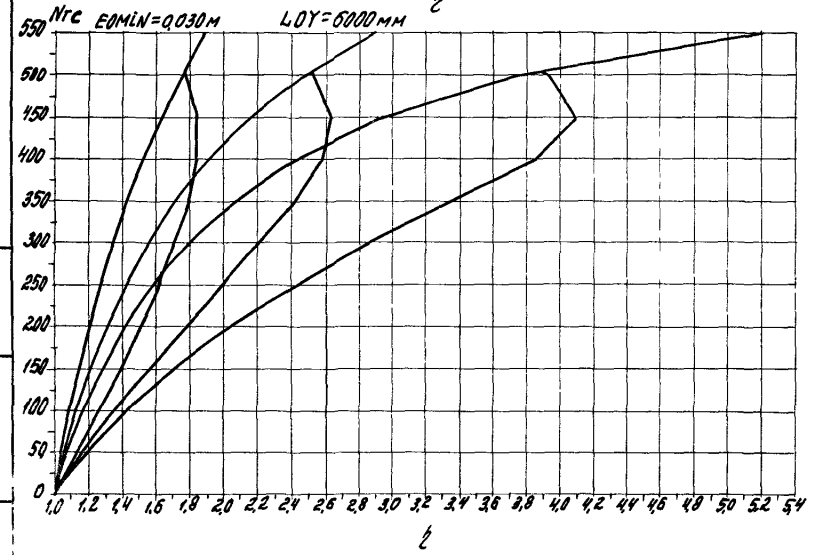
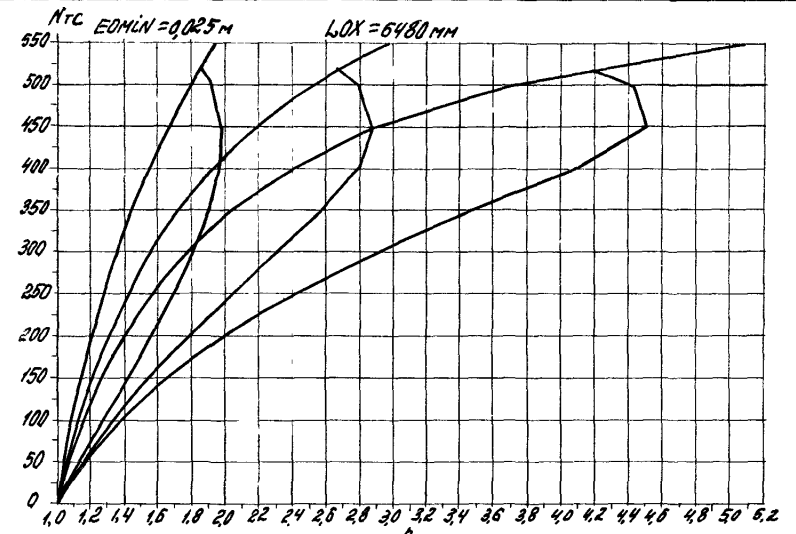
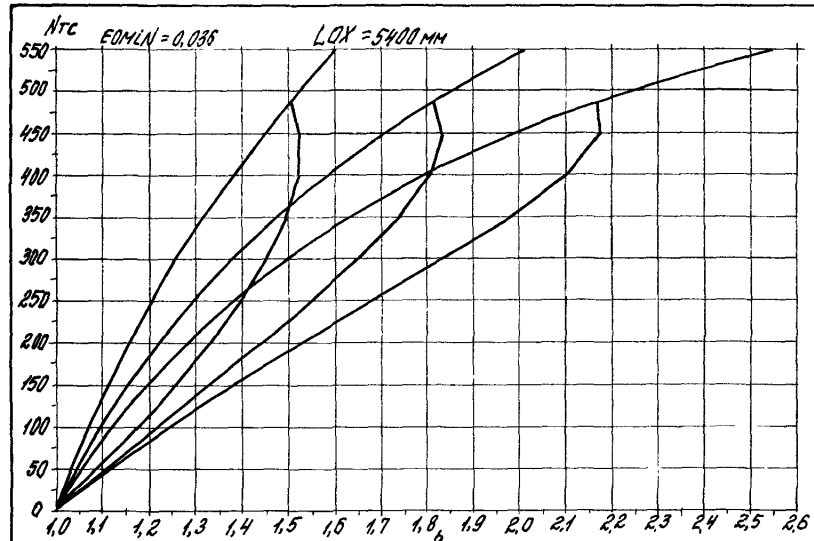

LIMITE INFERIORE DI CARRIERA - VALORE MIN. DI FIDUCIA

1.020. 1-4 C-Y 002

Nrc
220

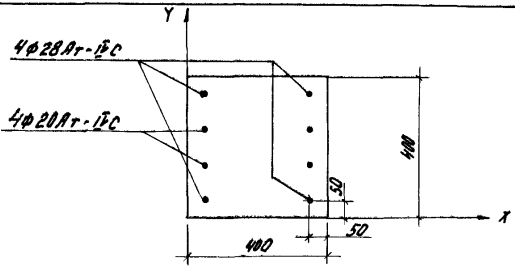
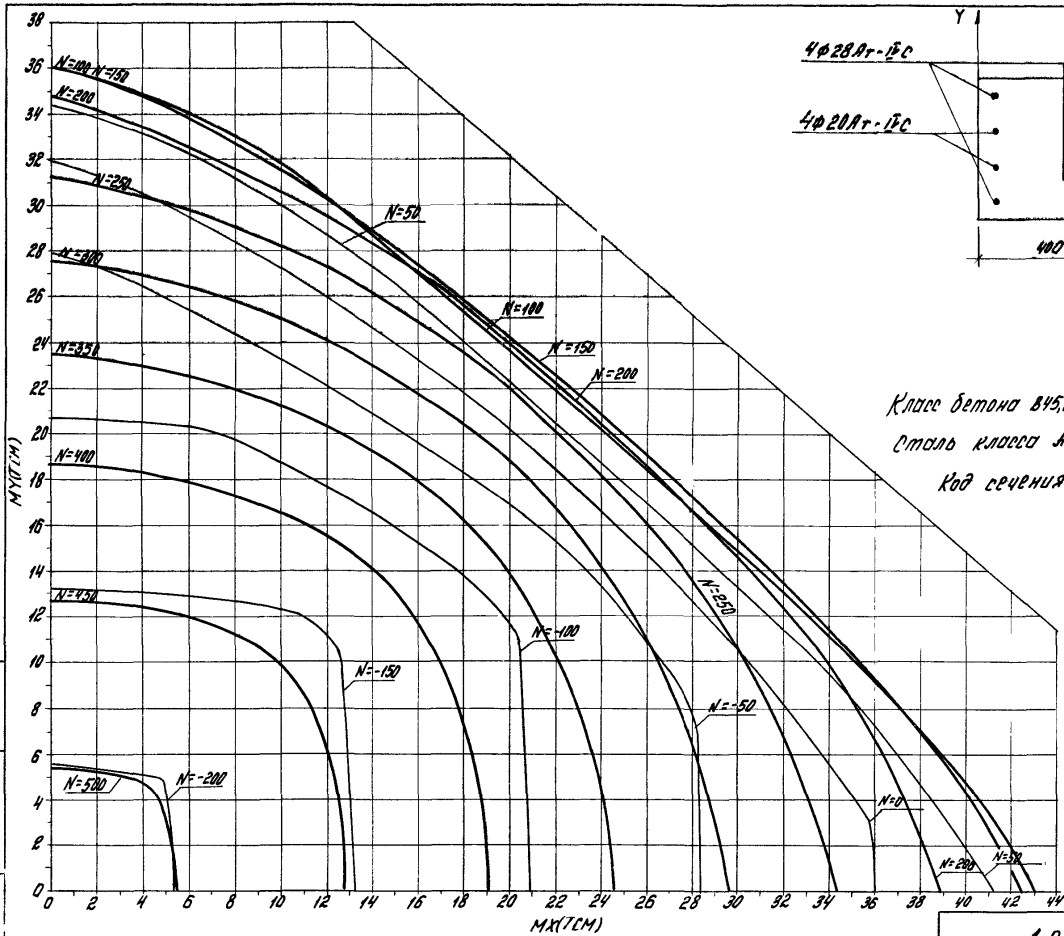

Класс бетона В15,0 ($R_b = 22,5 \text{ МПа}$ при учете $\gamma_{b2} = 0,90$)
 Сталь класса АТ-III
 Код сечения - 1288

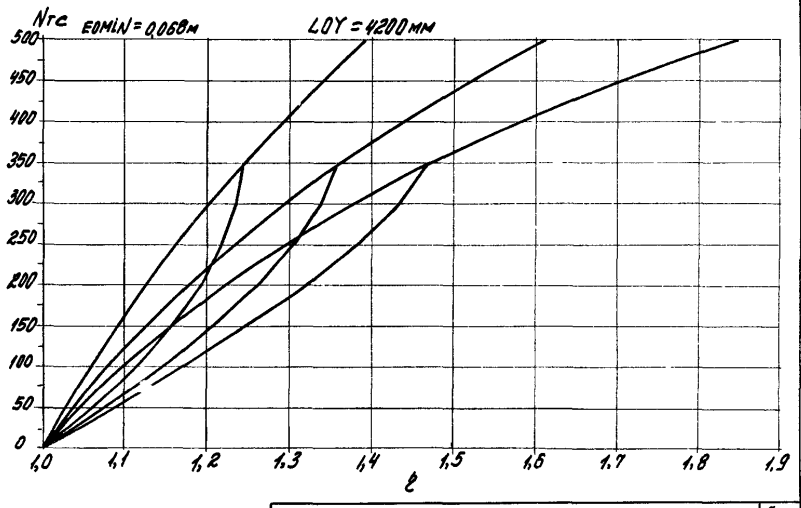
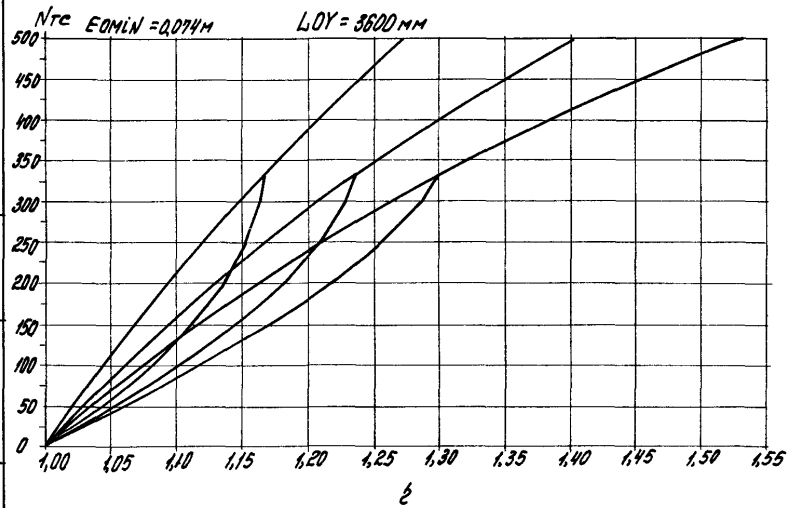
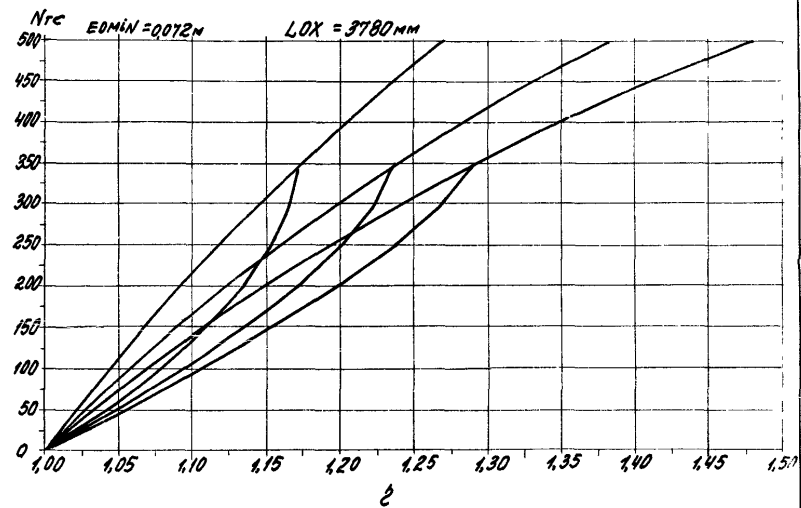
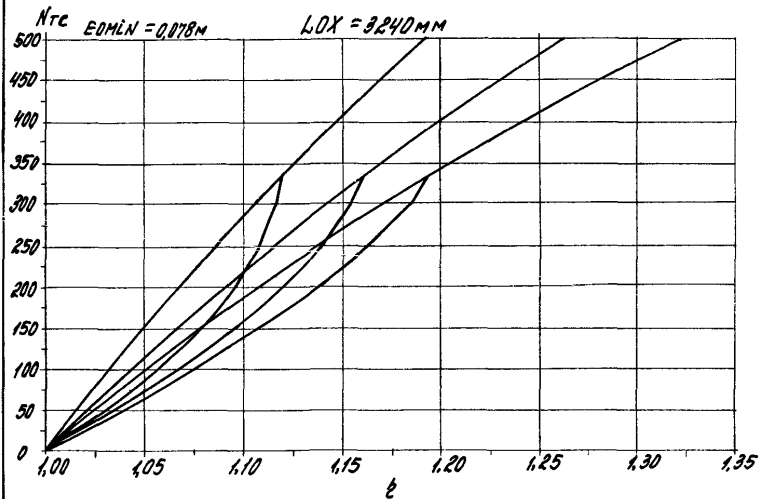

11/20/2011 11:00 AM 11/20/2011 11:00 AM 11/20/2011 11:00 AM

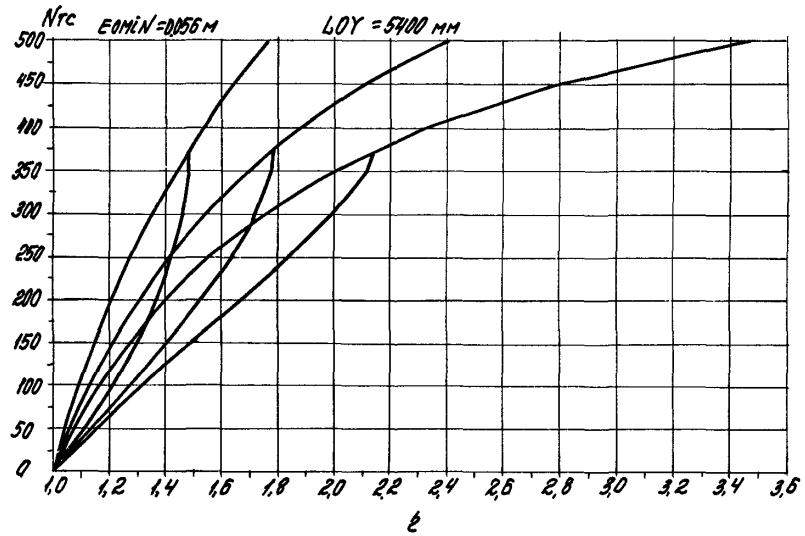
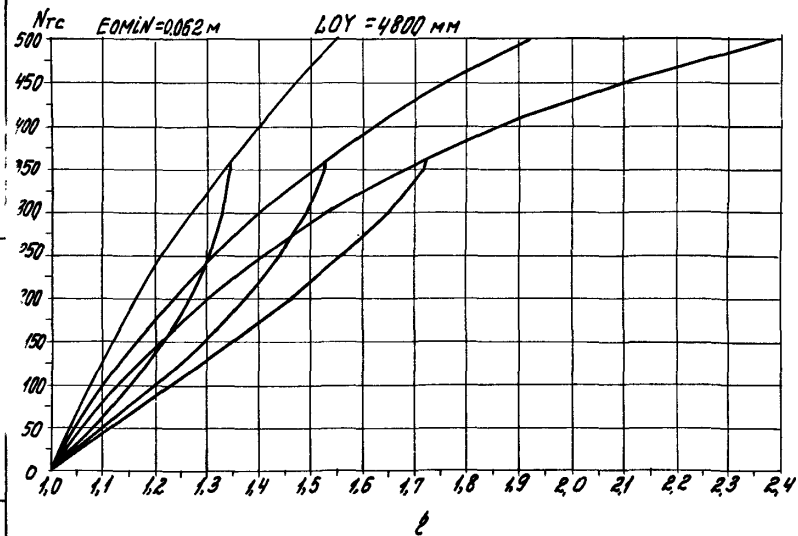
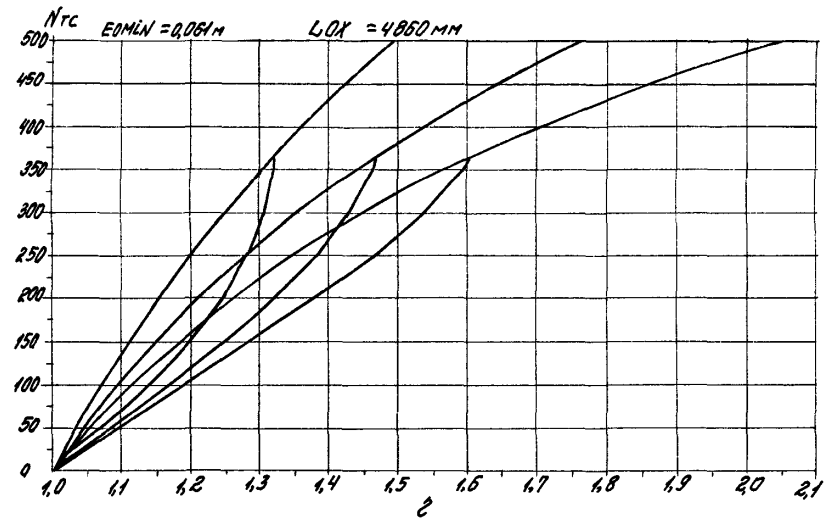
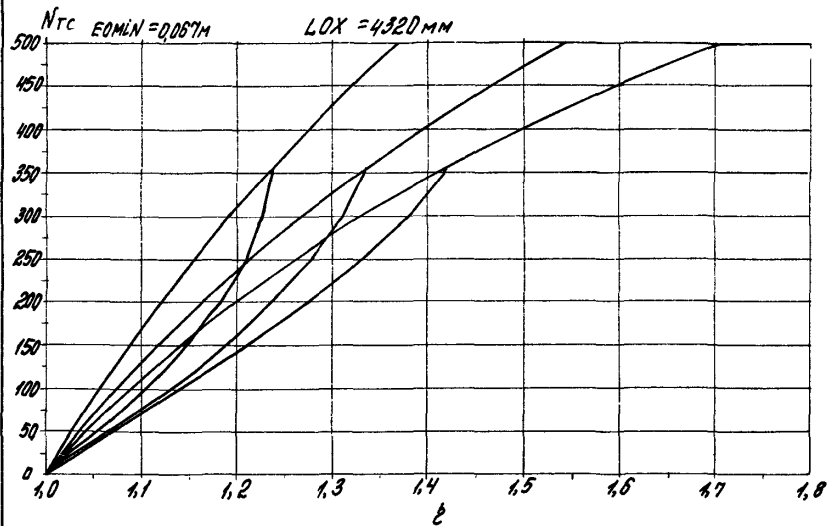

1.020. 1-4 0-9 002

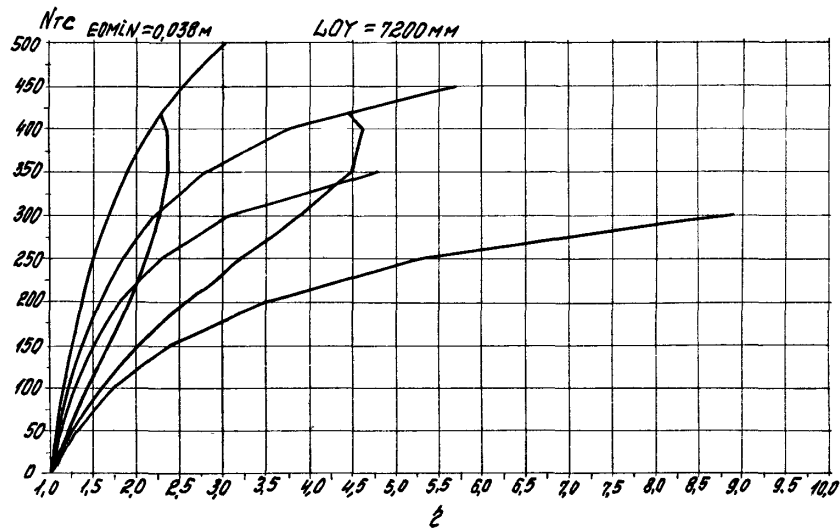
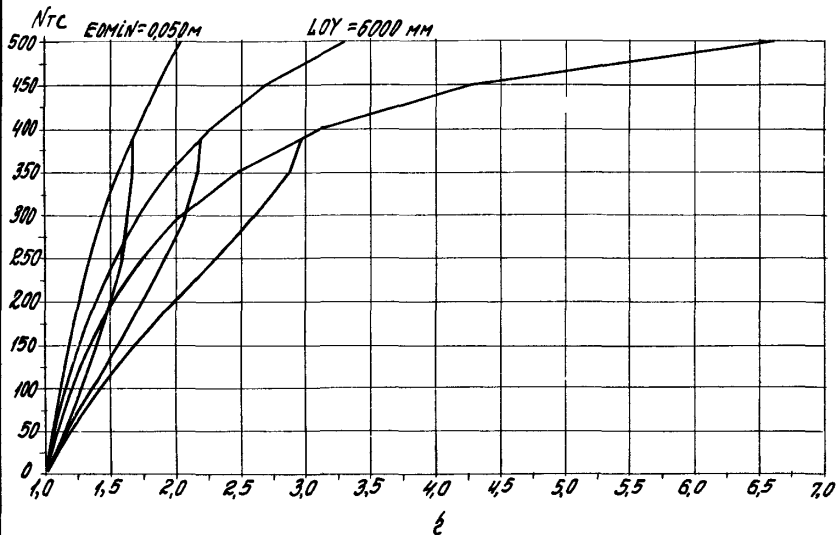
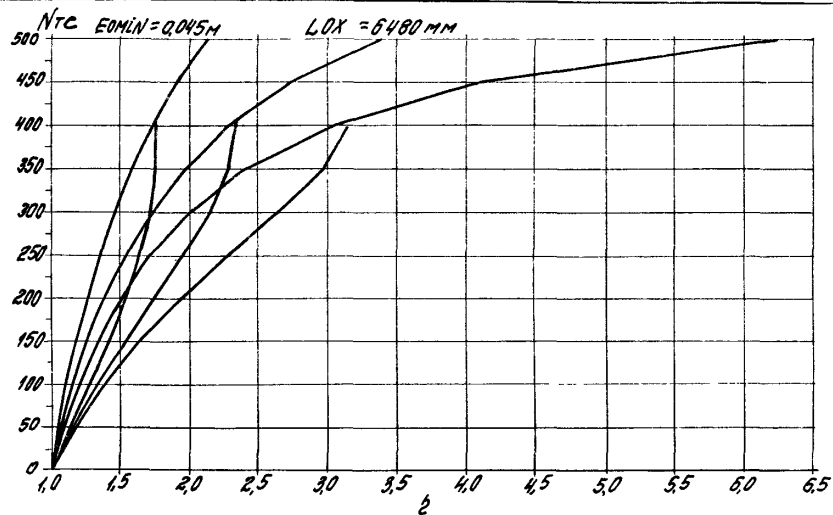
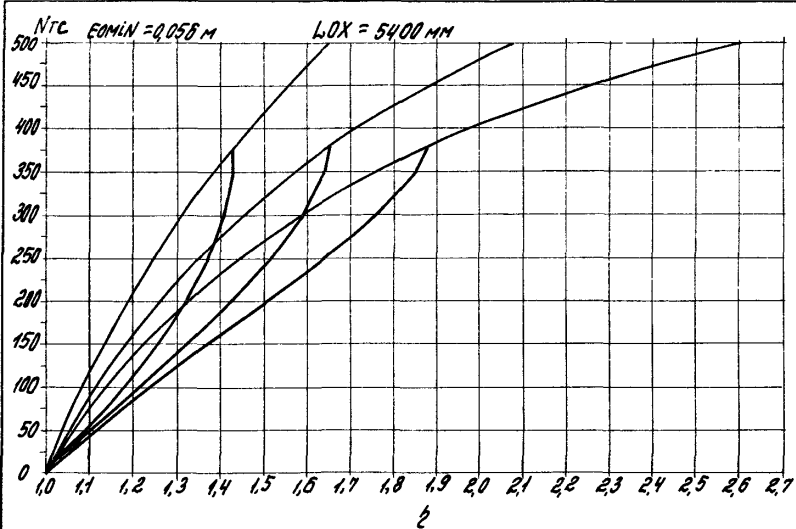

100
 200
 300
 400
 500
 600
 700
 800
 900
 1000
 1100
 1200
 1300
 1400
 1500
 1600
 1700
 1800
 1900
 2000
 2100
 2200
 2300
 2400
 2500
 2600
 2700
 2800
 2900
 3000
 3100
 3200
 3300
 3400
 3500
 3600
 3700
 3800
 3900
 4000
 4100
 4200
 4300
 4400
 4500
 4600
 4700
 4800
 4900
 5000
 5100
 5200
 5300
 5400
 5500
 5600
 5700
 5800
 5900
 6000
 6100
 6200
 6300
 6400
 6500
 6600
 6700
 6800
 6900
 7000
 7100
 7200
 7300
 7400
 7500
 7600
 7700
 7800
 7900
 8000
 8100
 8200
 8300
 8400
 8500
 8600
 8700
 8800
 8900
 9000
 9100
 9200
 9300
 9400
 9500
 9600
 9700
 9800
 9900
 10000
 10100
 10200
 10300
 10400
 10500
 10600
 10700
 10800
 10900
 11000
 11100
 11200
 11300
 11400
 11500
 11600
 11700
 11800
 11900
 12000
 12100
 12200
 12300
 12400
 12500
 12600
 12700
 12800
 12900
 13000
 13100
 13200
 13300
 13400
 13500
 13600
 13700
 13800
 13900
 14000
 14100
 14200
 14300
 14400
 14500
 14600
 14700
 14800
 14900
 15000
 15100
 15200
 15300
 15400
 15500
 15600
 15700
 15800
 15900
 16000
 16100
 16200
 16300
 16400
 16500
 16600
 16700
 16800
 16900
 17000
 17100
 17200
 17300
 17400
 17500
 17600
 17700
 17800
 17900
 18000
 18100
 18200
 18300
 18400
 18500
 18600
 18700
 18800
 18900
 19000
 19100
 19200
 19300
 19400
 19500
 19600
 19700
 19800
 19900
 20000

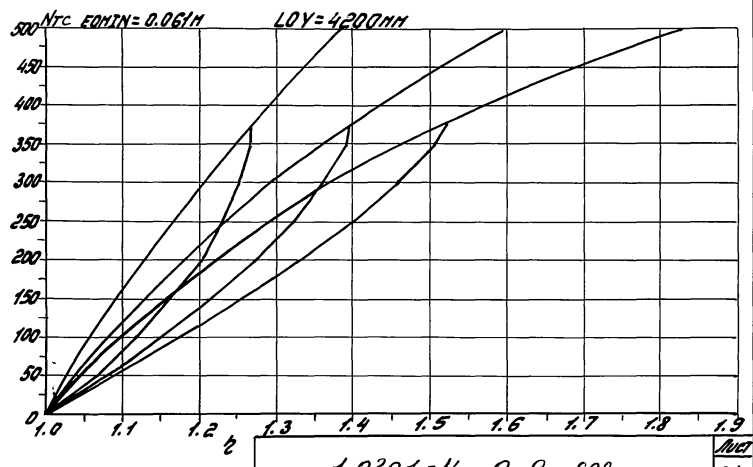
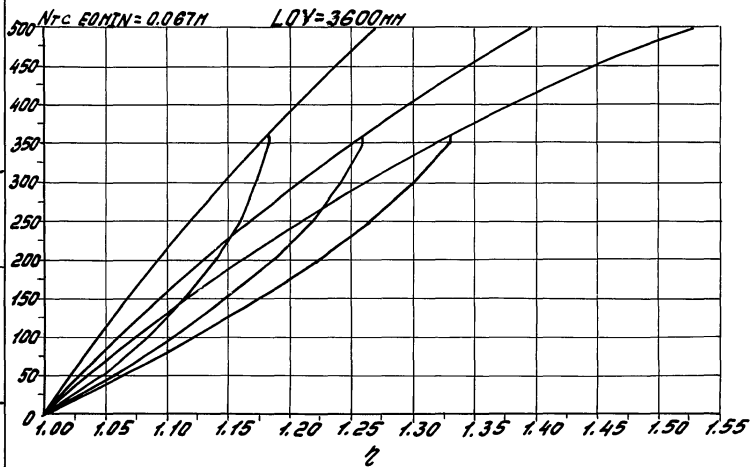
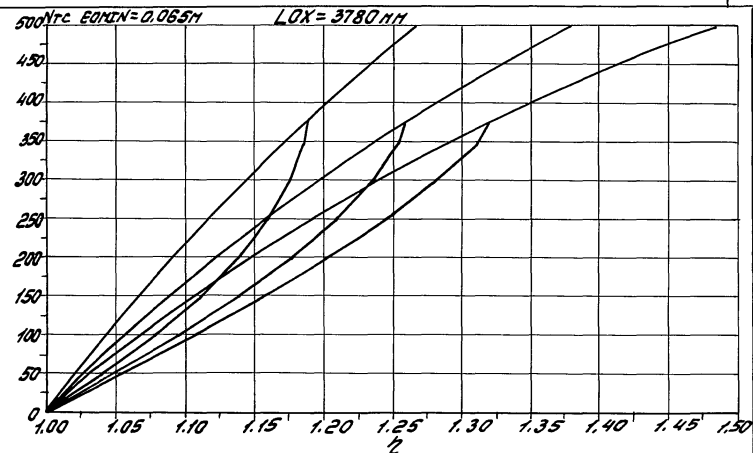
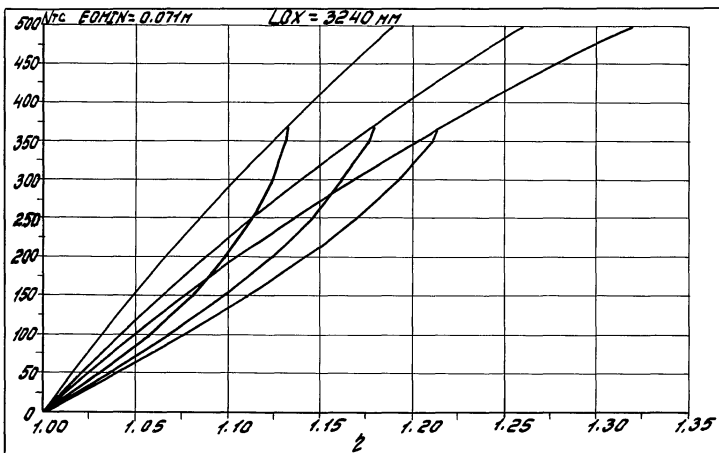

Умр. А. мрежа. / радмис и брмис брм. умр. А.

1.020.1-4 0-9 002

210

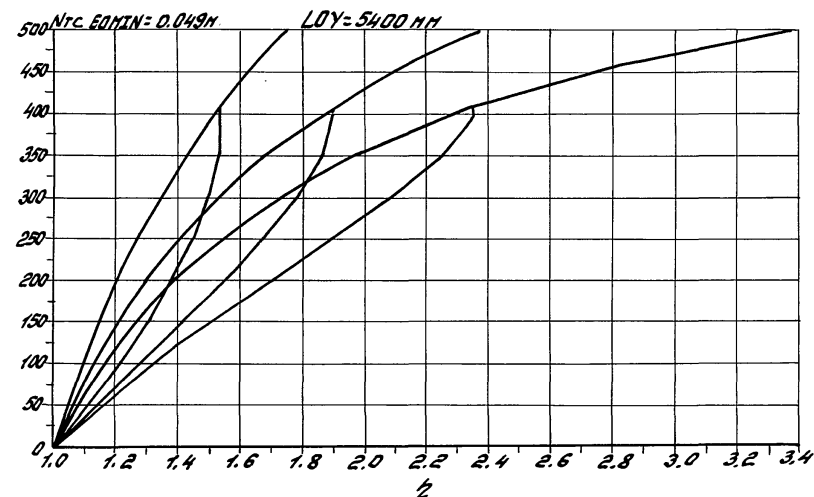
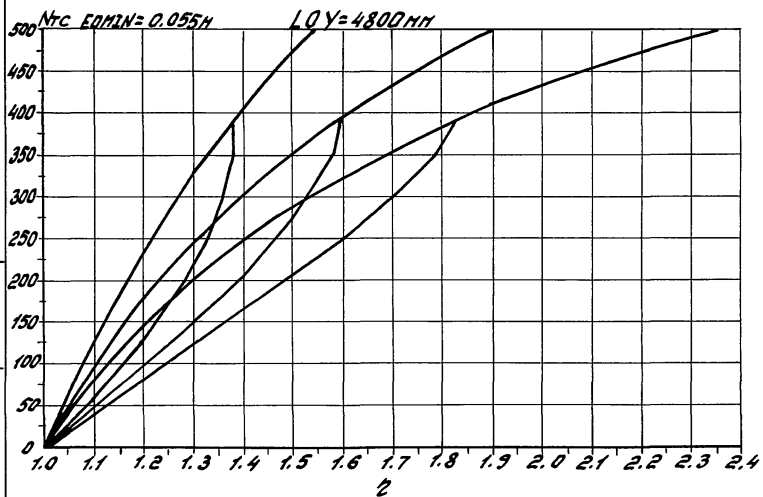
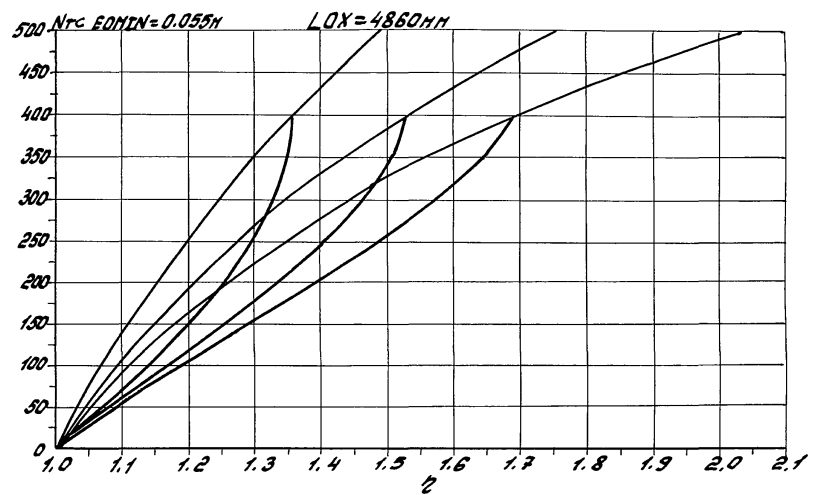
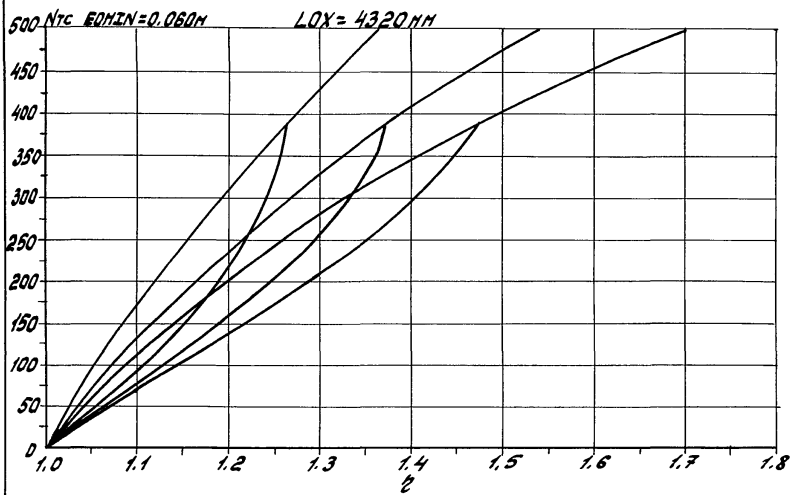

1.020.1-4 0-9 002
 211

1.020.1-4 0-9 002

116
211

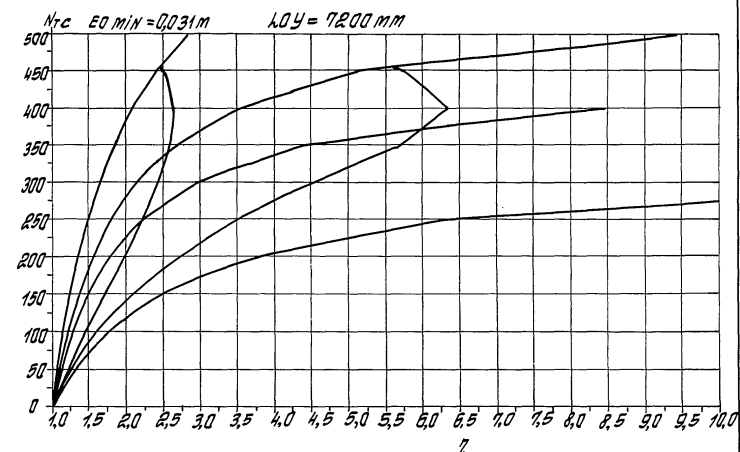
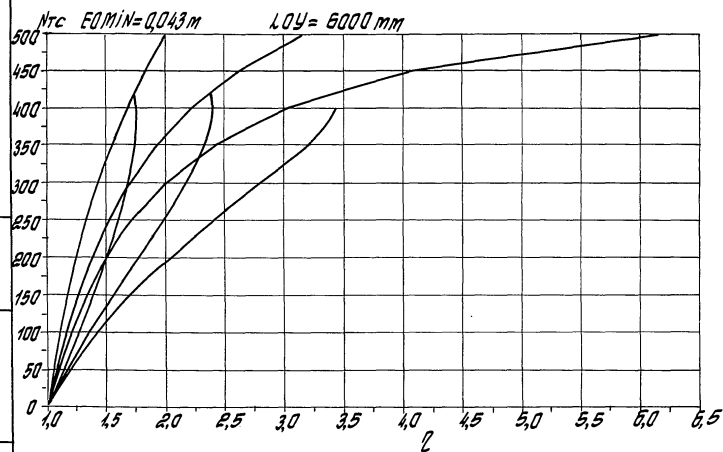
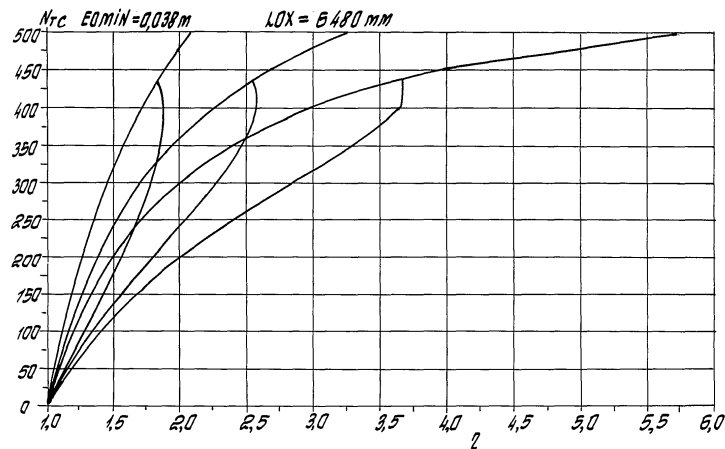
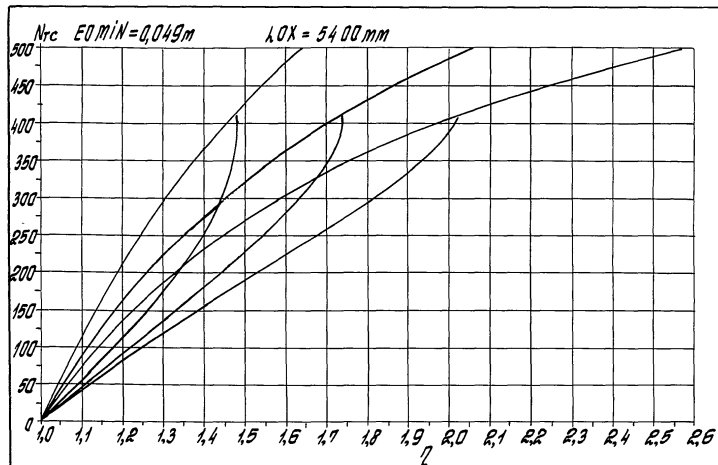

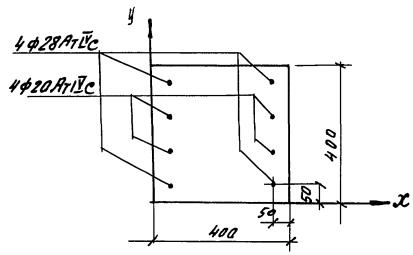
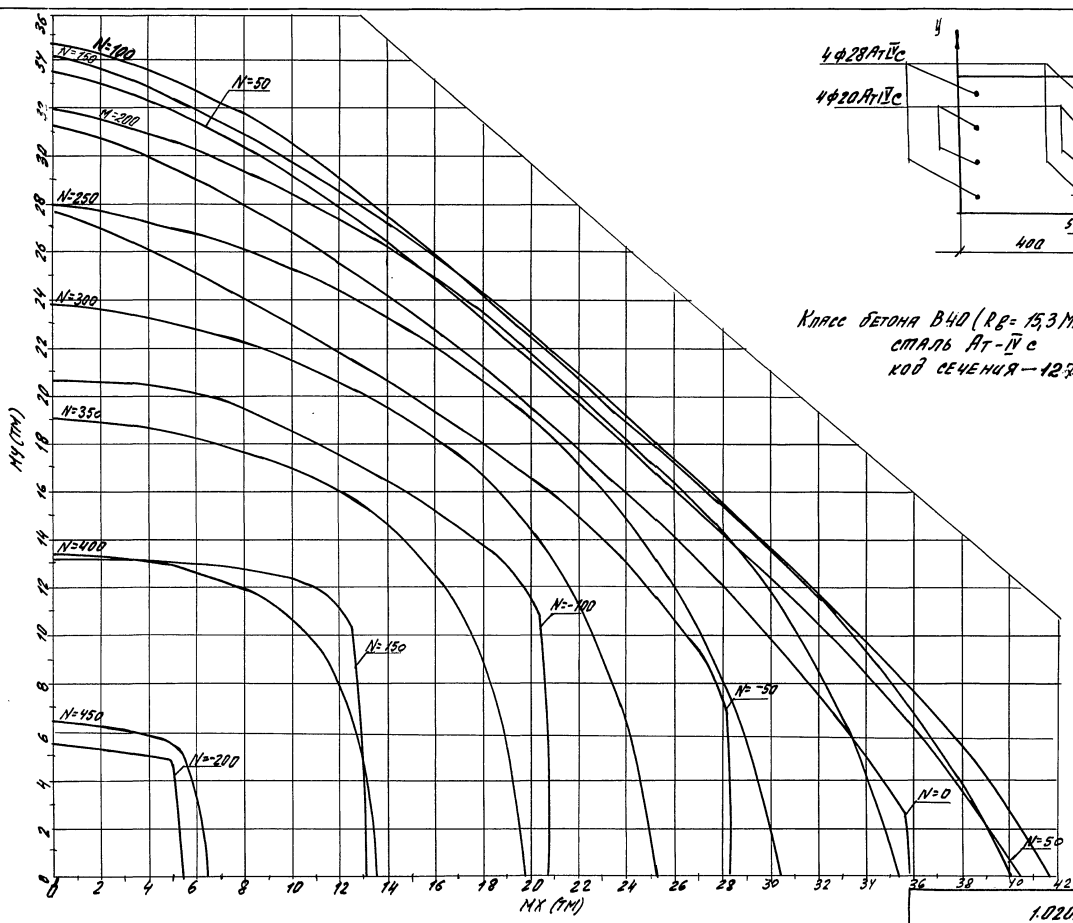

Класс бетона В40 ($R_b = 15,3 \text{ МПа}$ при учете $\gamma_{b2} = 0,90$)
 СТАЛЬ А1-IV c
 КОД СЕЧЕНИЯ - 1275

УИИ. И.Е. ПОД. Подпись и штамп инженера

1.020.1-4 0-9 002

24166-02 118

лист
213

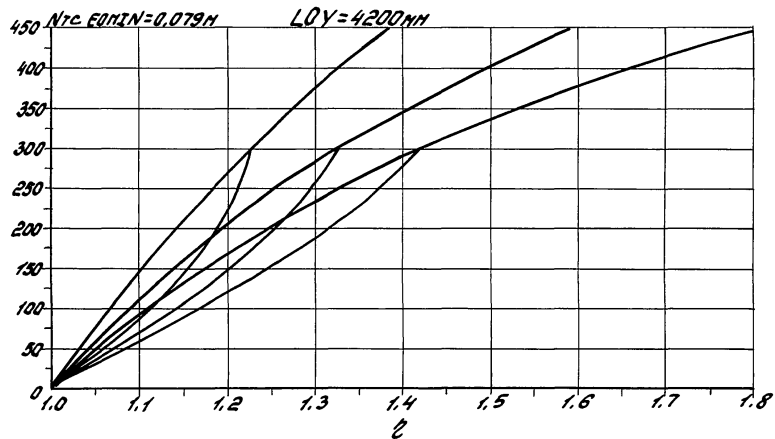
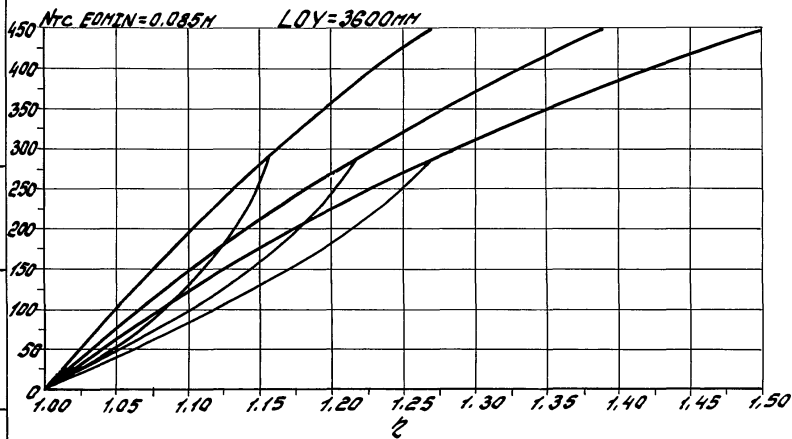
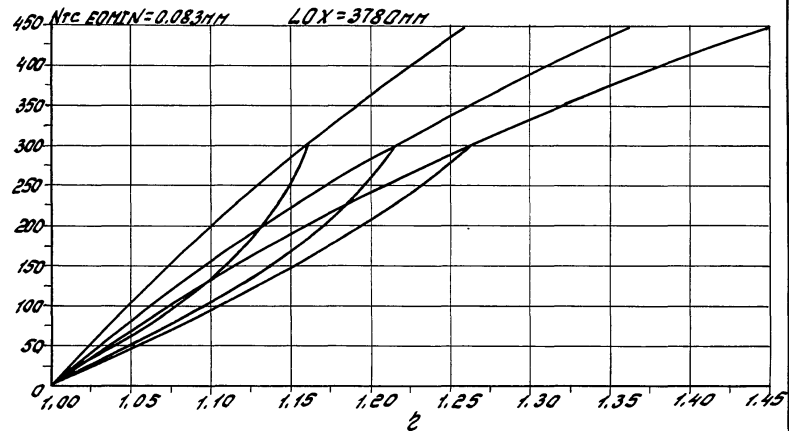
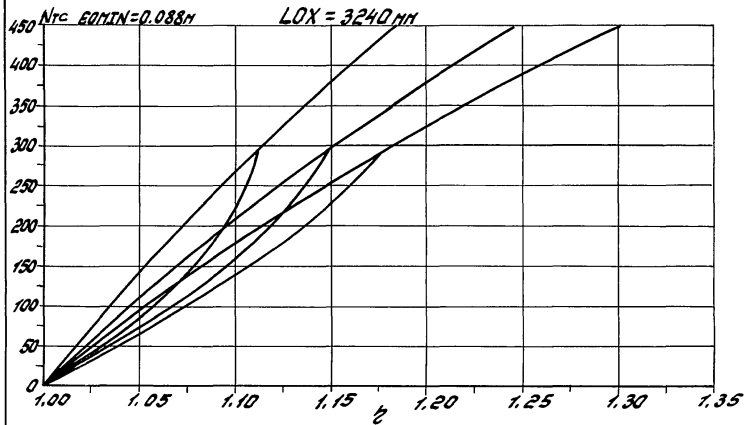

1.020.1-4 0-9 002

24166-02 119

1/100
214

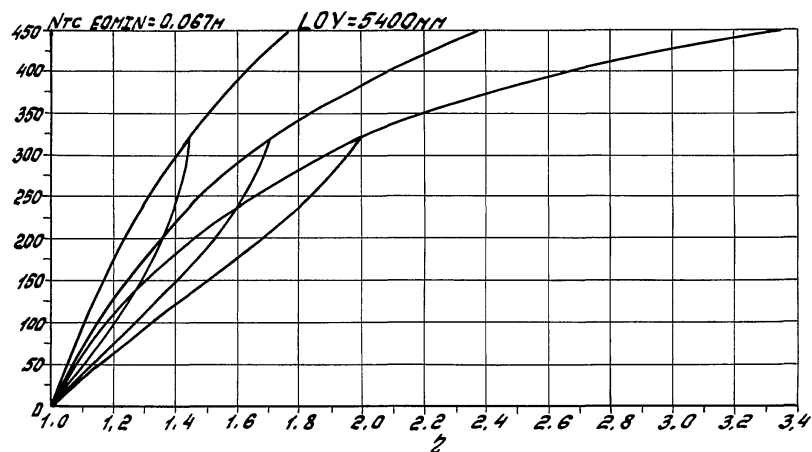
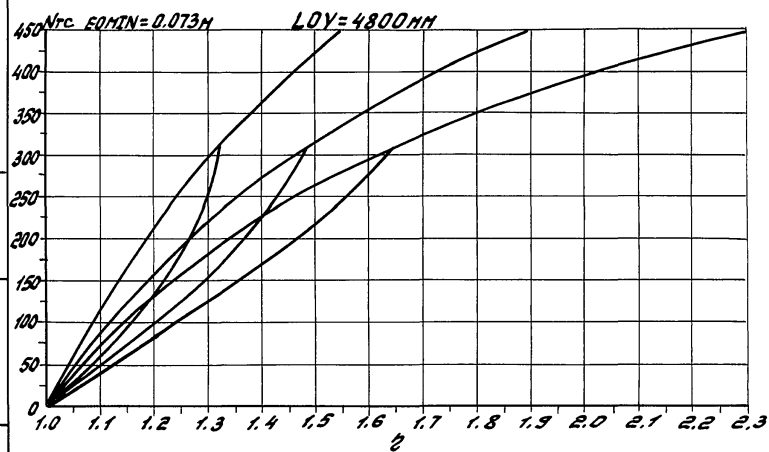
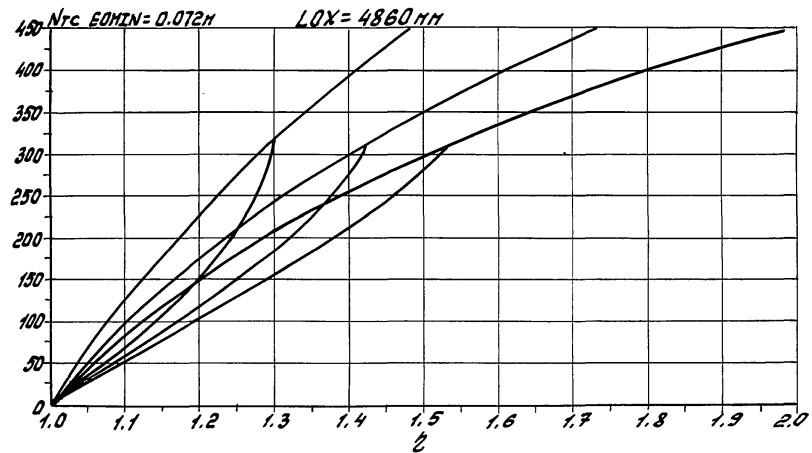
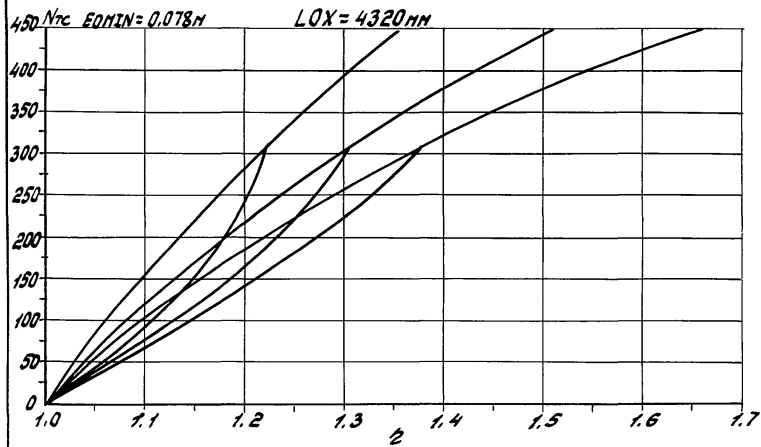

450 NTC EDMIN=0.078M
 450 NTC EDMIN=0.072M
 450 NTC EDMIN=0.073M
 450 NTC EDMIN=0.067M

1.020.1-4 0-9 002

1020
215

24166-02 120

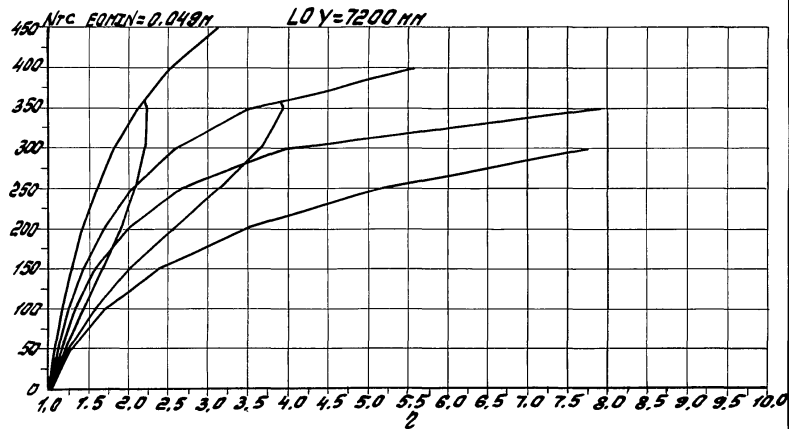
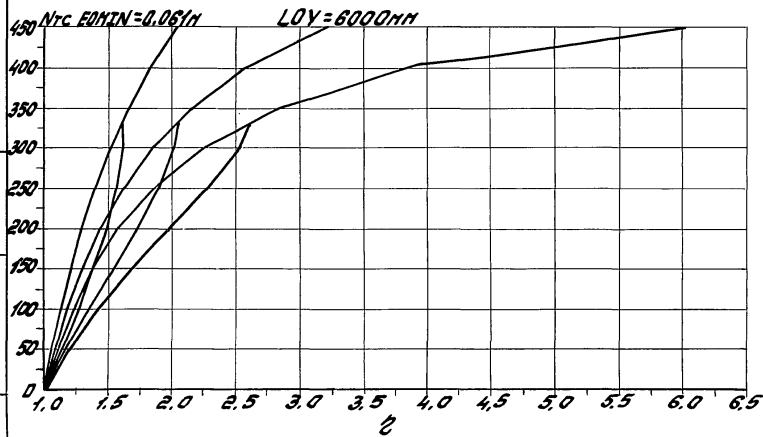
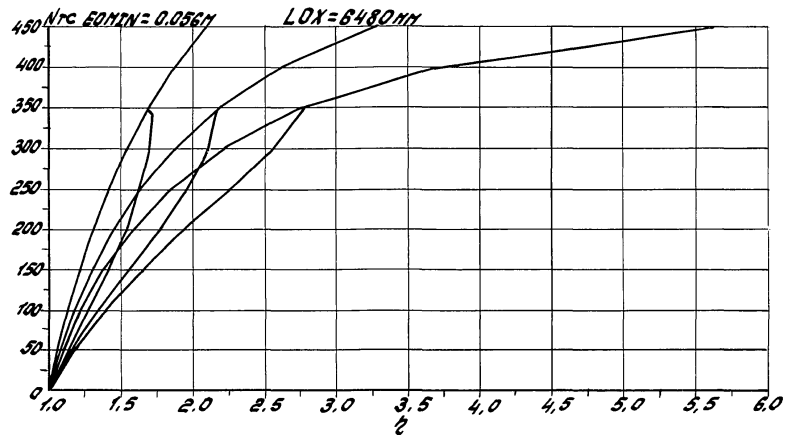
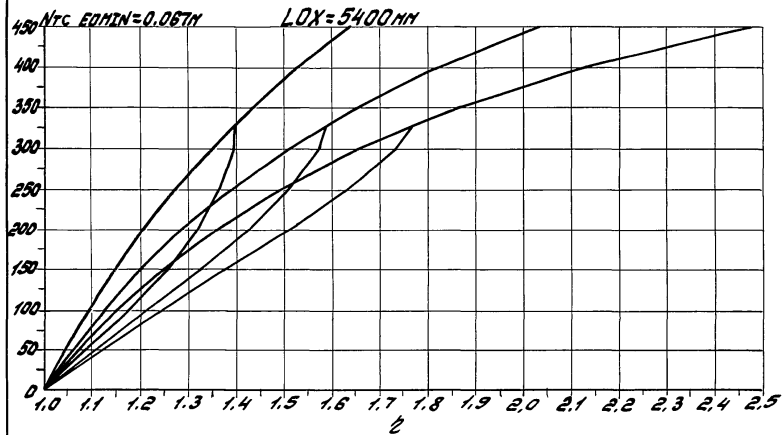

Указатель значений в строке "Значения" см. стр. 216

1.020.1-4 0-9 002

Лист

216

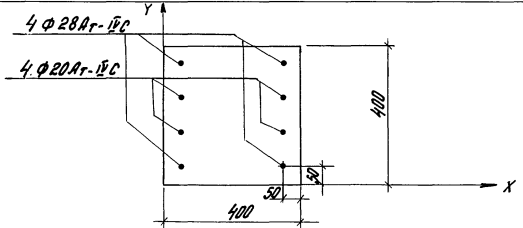
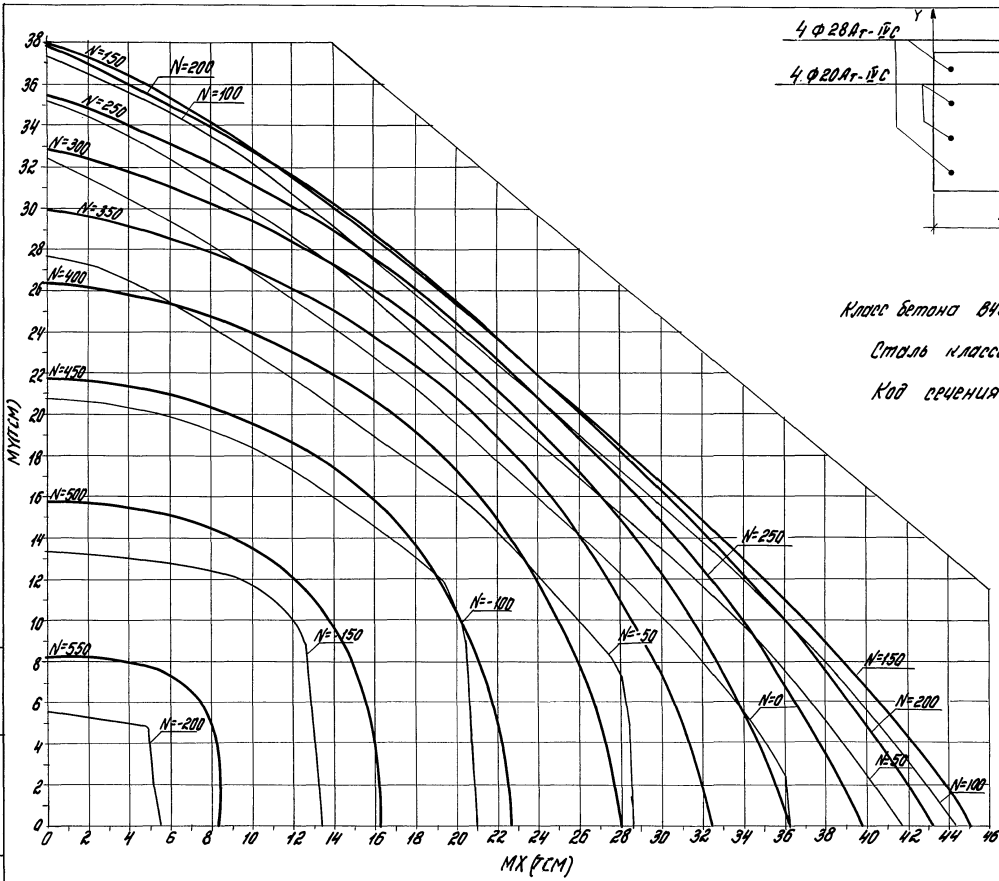

Класс бетона В450 ($R_R = 27,5 \text{ МПа}$ при $\gamma_{R2} = 1,10$)
 Сталь класса Ar-IVC.
 Код ревернуа-128а.

Указ. Номер в таблице и размер. Выход. лист № 1

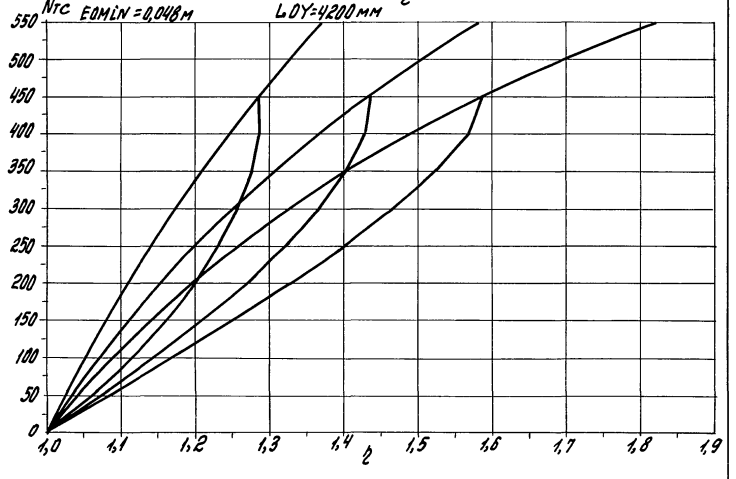
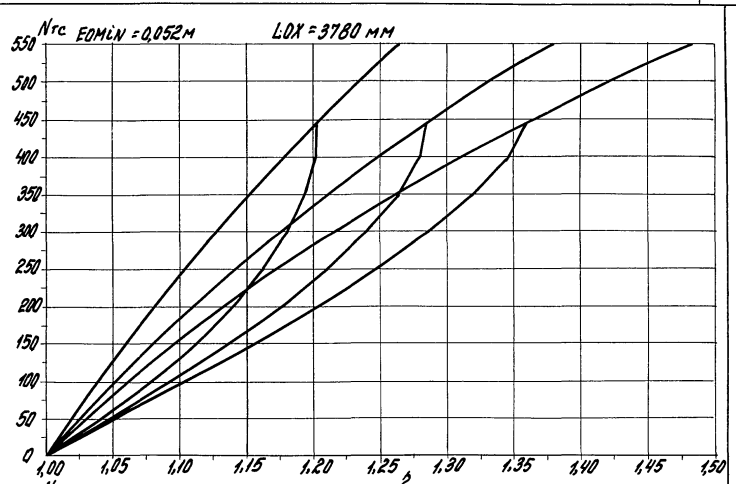
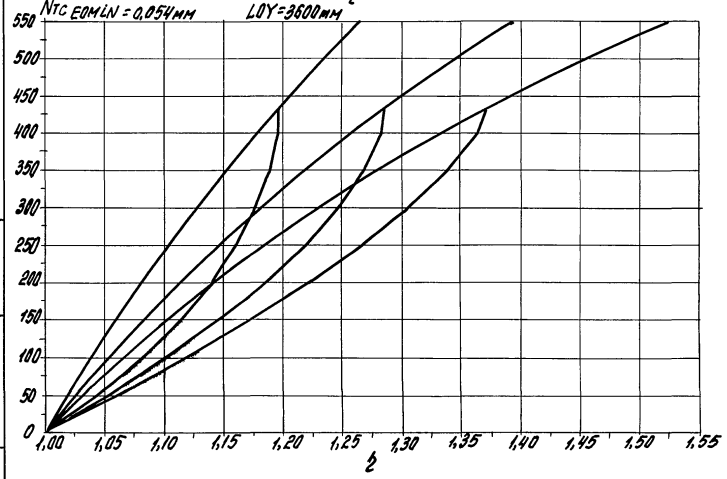
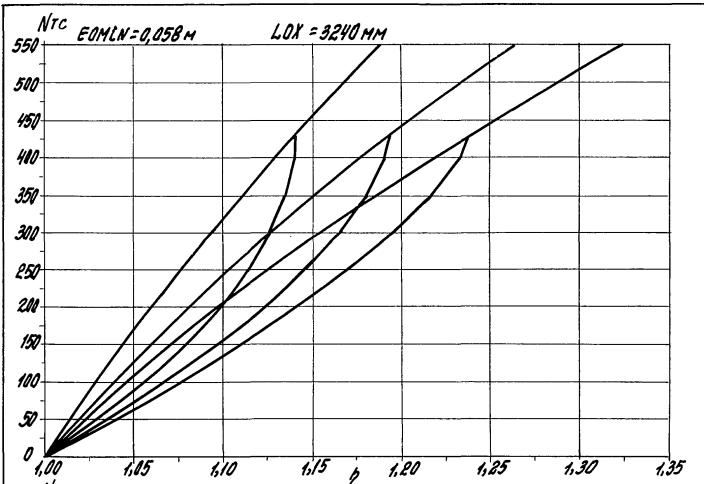

Лист №104/1
Титульный лист
ЭБФМ. Лист №104

1.020. 1-4 0-9 002

Лист	218
------	-----

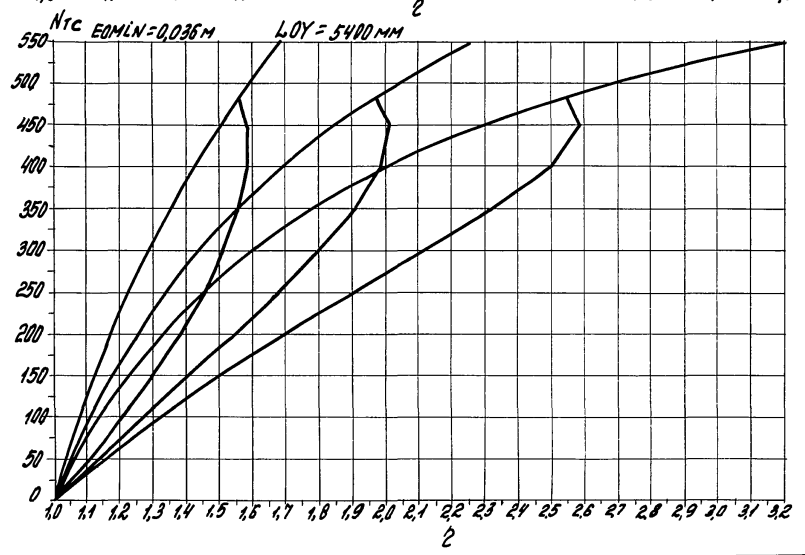
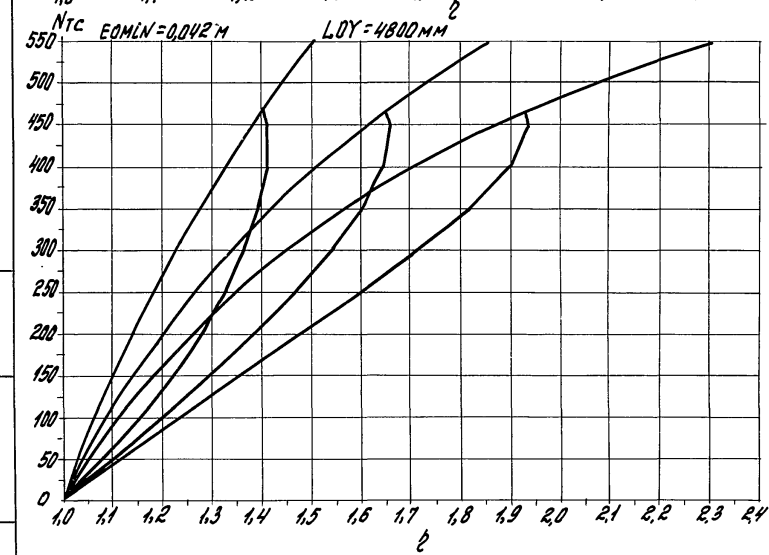
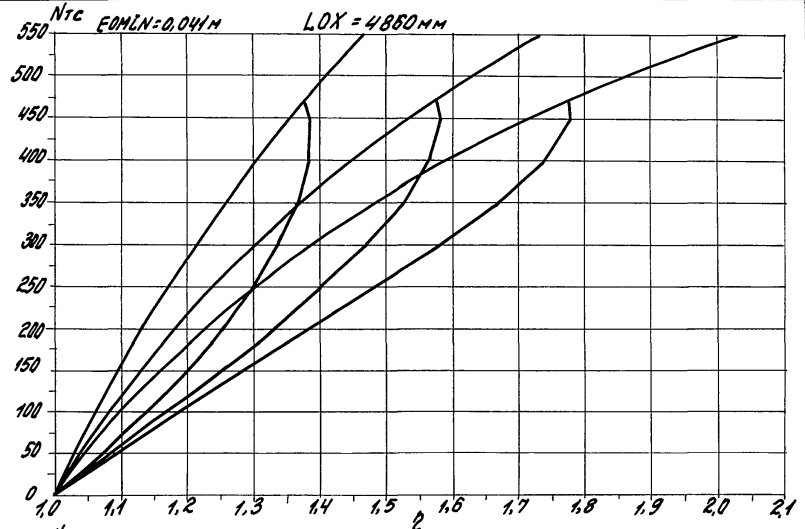
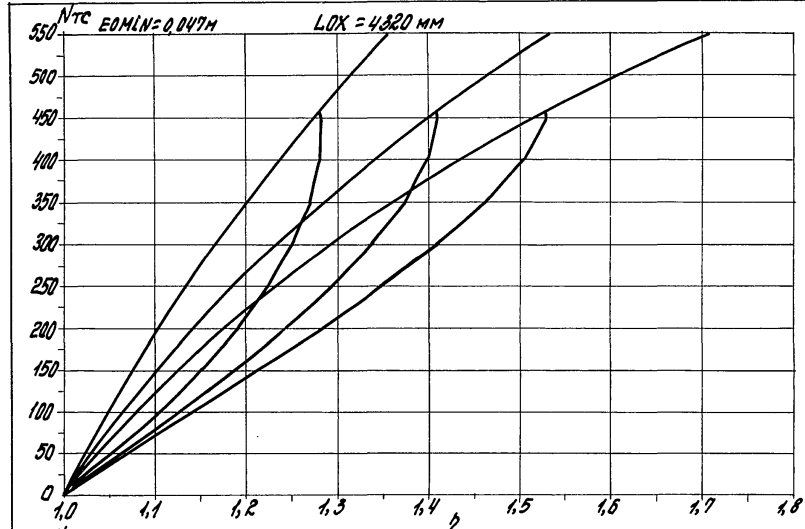

1.020.1-4 0-9 002
 24166-02 124

1.020.1-4	0-9 002	1/2000
24166-02	124	219

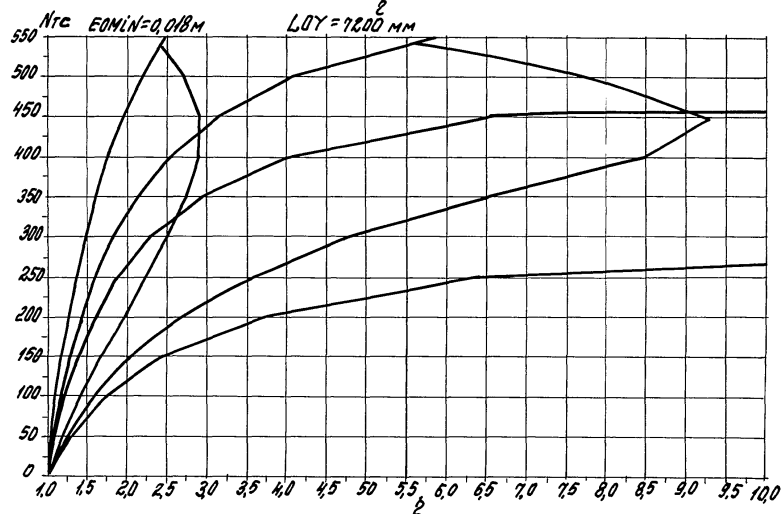
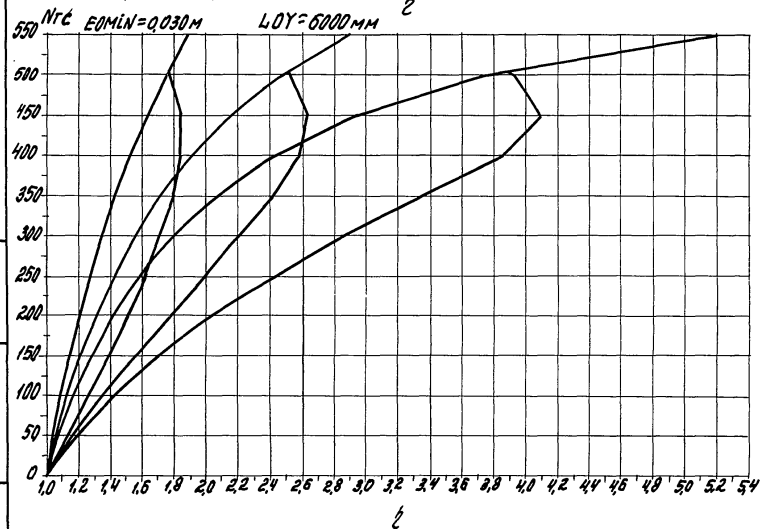
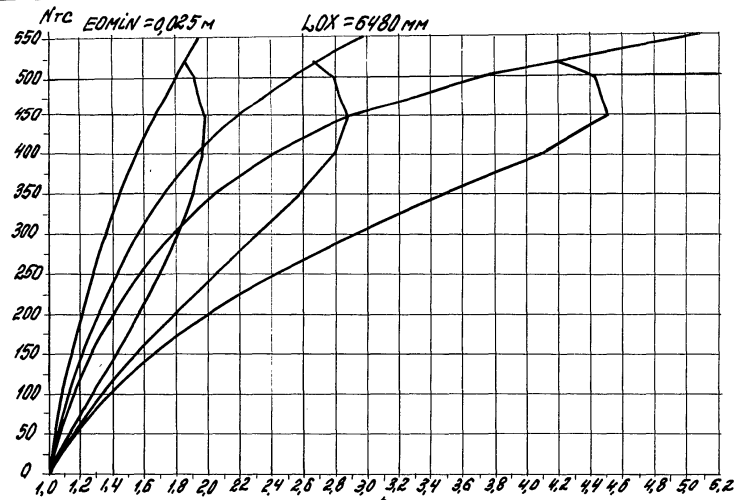
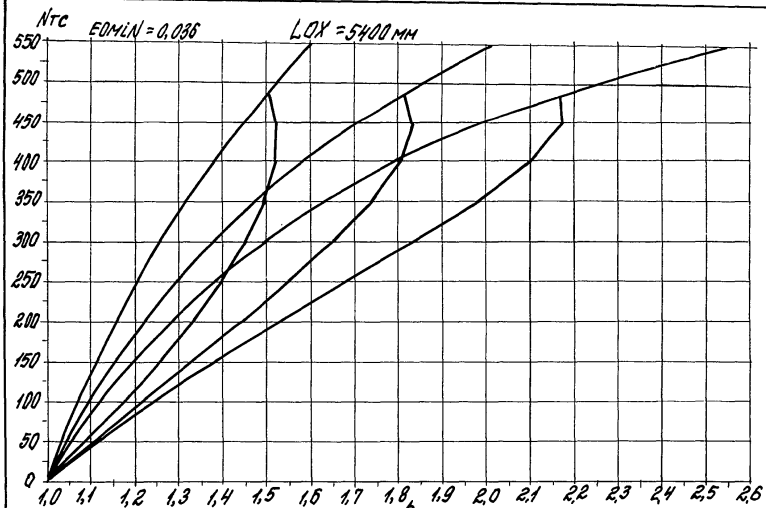

1.020. 1-4 0-9 002

NTC
220

24166-02 125

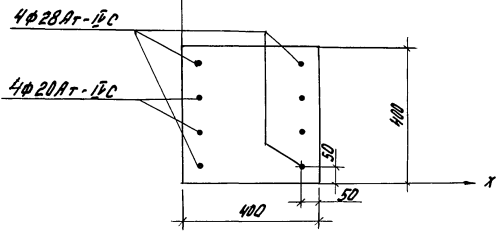
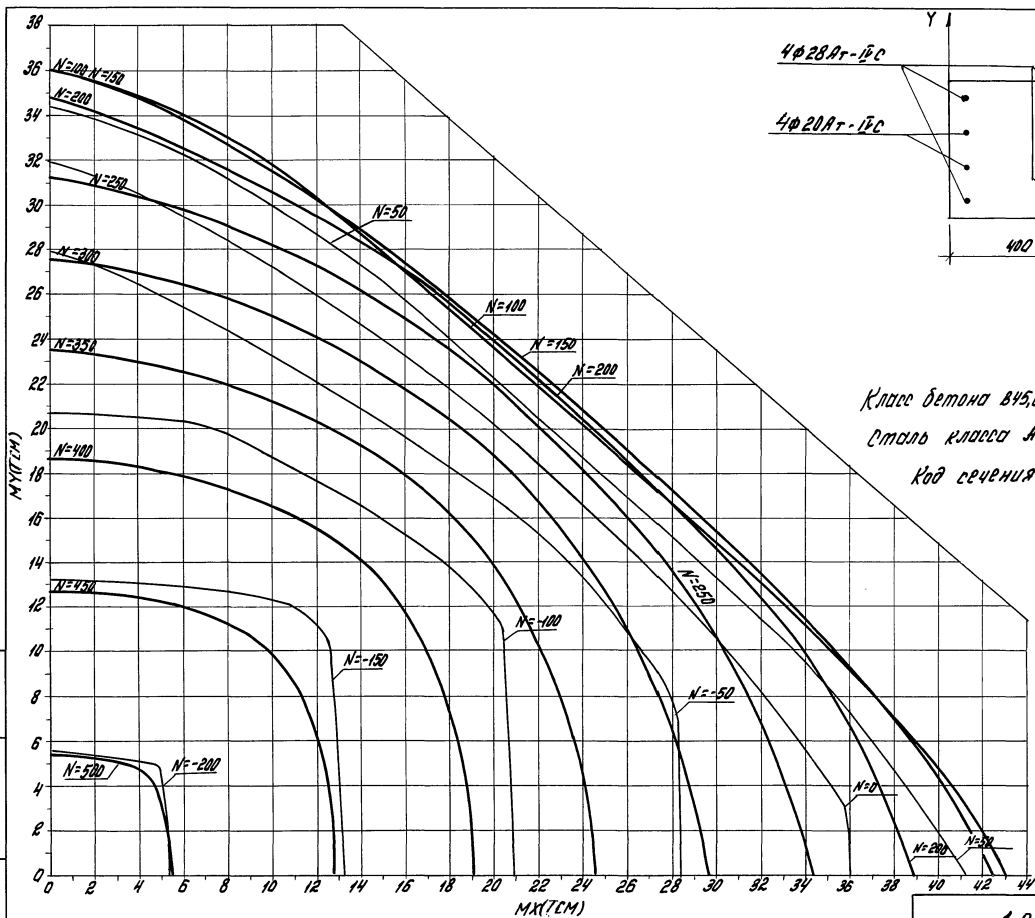

Класс бетона В45,0 ($R_b=22,5$ МПа при учете $\delta f_{yk}=0,90$)

Сталь класса Ат-IVC

Код сечения -128Б

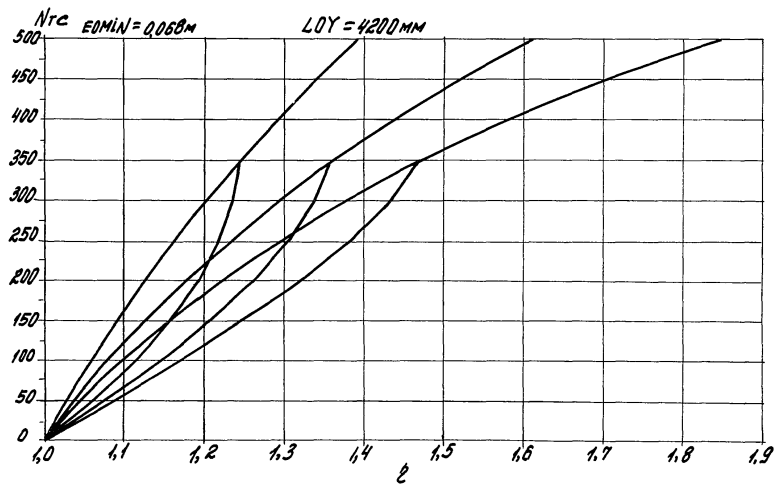
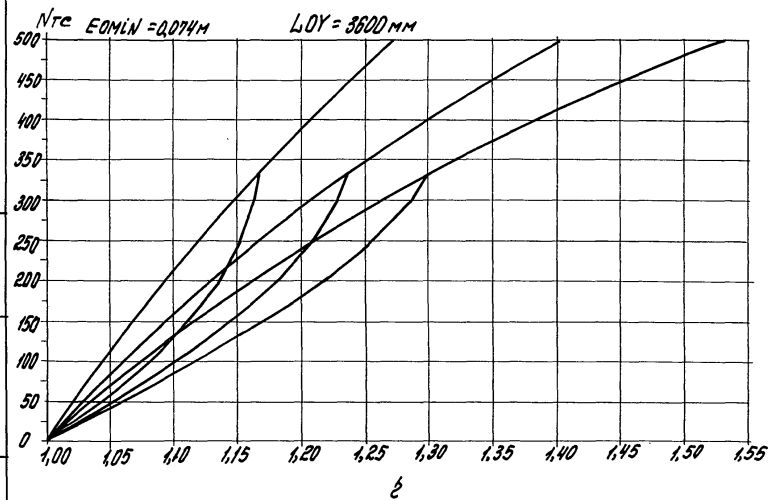
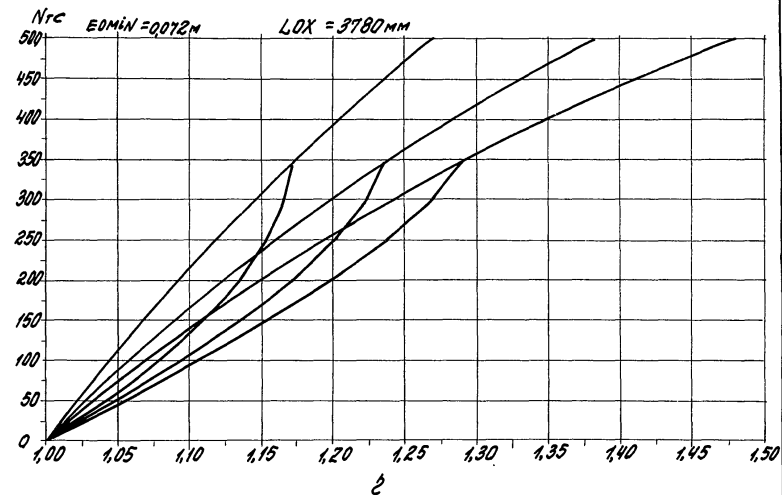
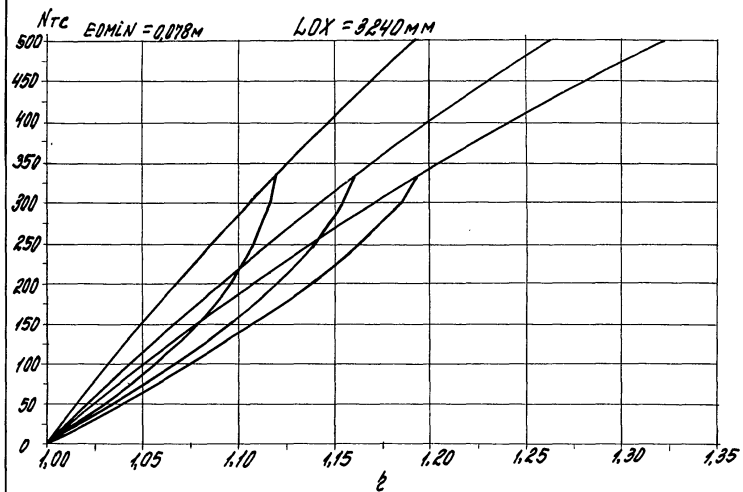

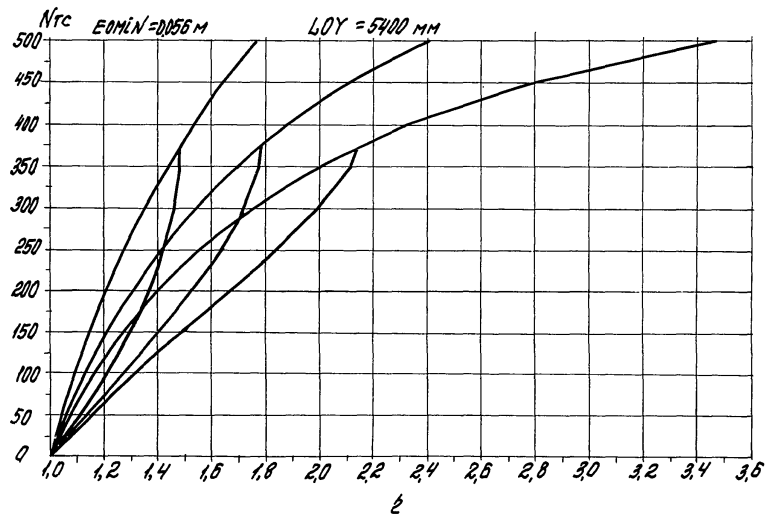
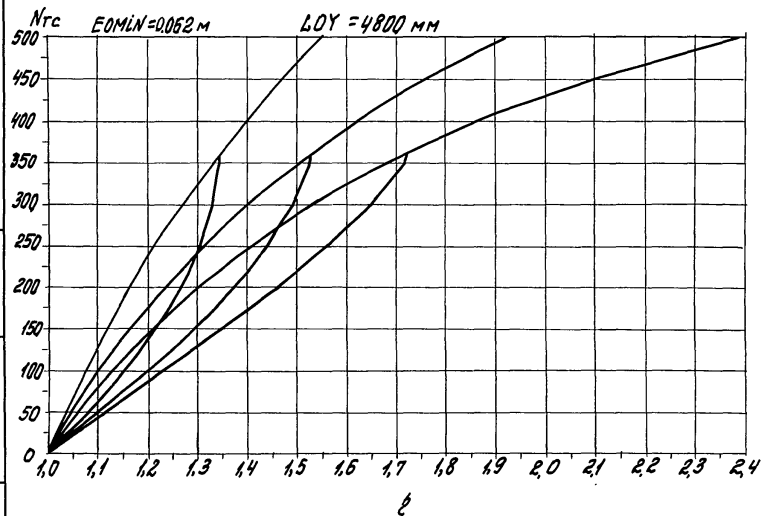
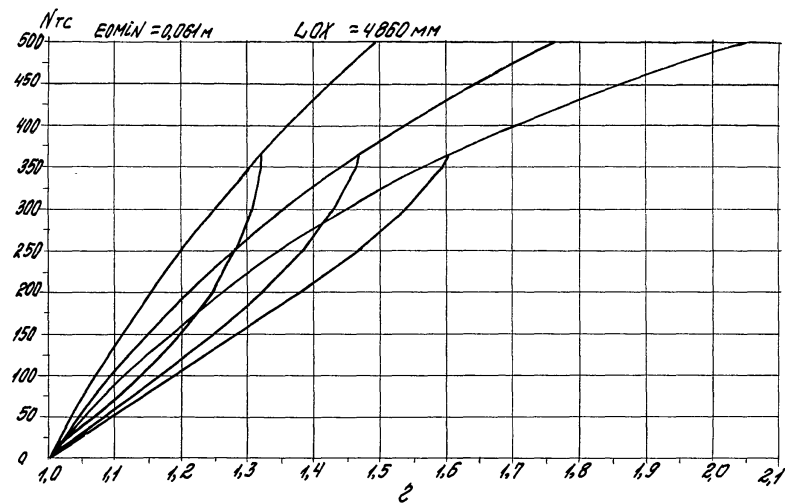
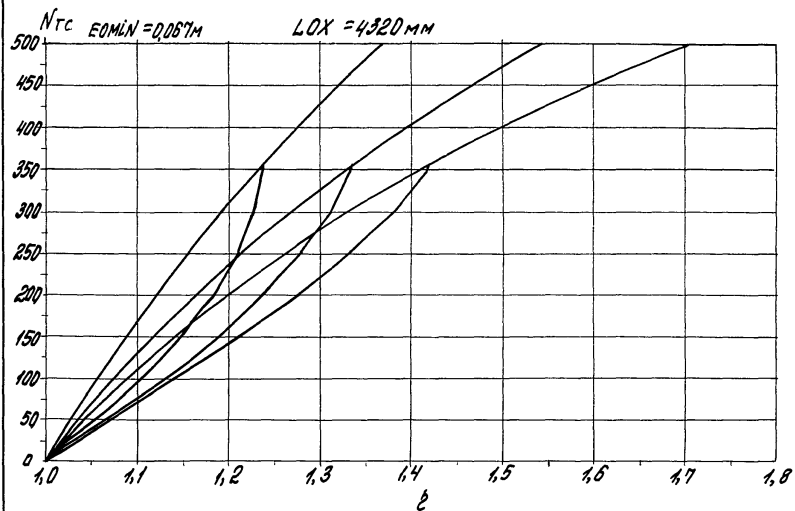

Чис. 19002. Подпись и дата. Сем. 1977. №

1.020. 1-4 0-9 002

19002
223

24166-02 128



Диаграмма: Излучение в диапазоне 0,038-0,058 М

1.020.1-4 0-9 002

24166-02 (129)

Лист
224

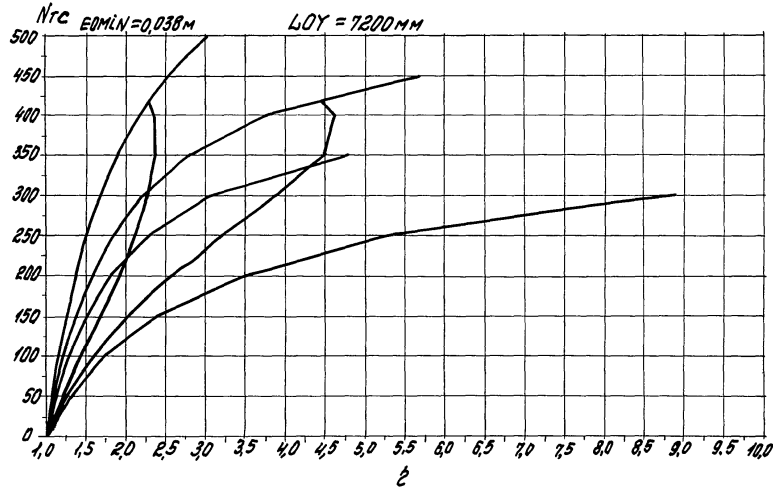
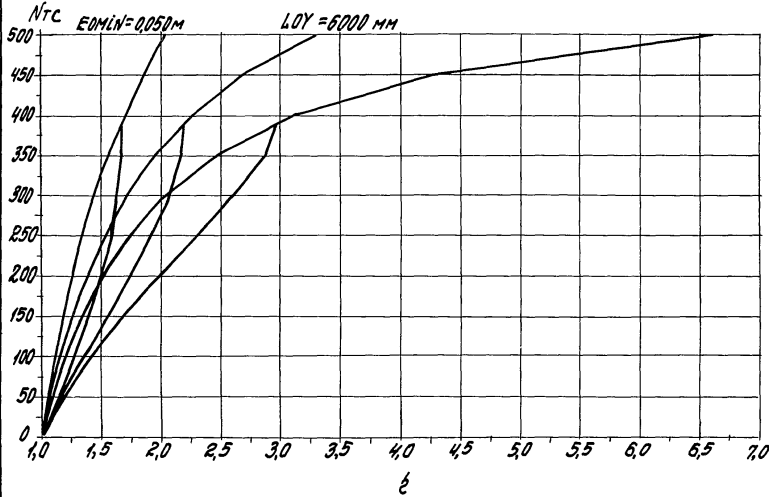
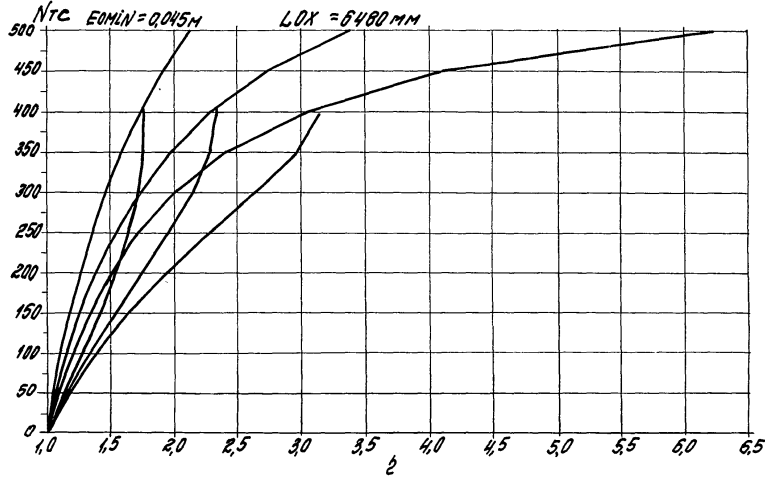
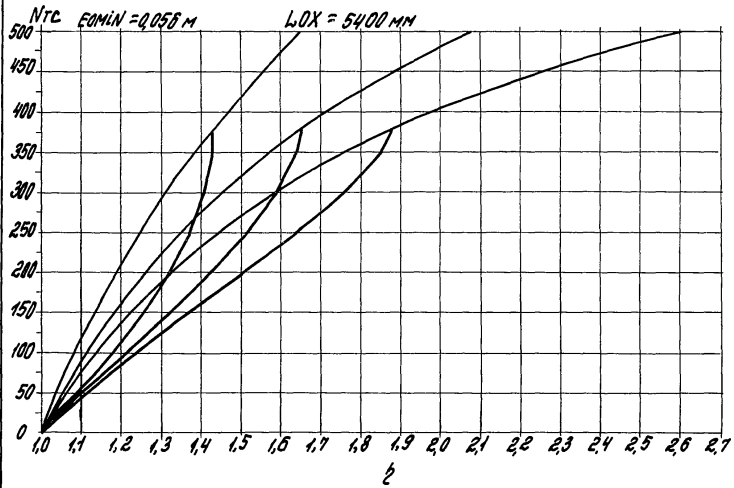
Копия