

ТИПОВЫЕ КОНСТРУКЦИИ, ИЗДЕЛИЯ И УЗЛЫ ЗДАНИЙ И СООРУЖЕНИЙ

СЕРИЯ 1.020.1-4

КОНСТРУКЦИИ РАМНОГО КАРКАСА МЕЖВИДОВОГО ПРИМЕНЕНИЯ
ДЛЯ МНОГОЭТАЖНЫХ ОБЩЕСТВЕННЫХ ЗДАНИЙ, ПРОИЗВОДСТВЕННЫХ
И ВСПОМОГАТЕЛЬНЫХ ЗДАНИЙ ПРОМЫШЛЕННЫХ ПРЕДПРИЯТИЙ

выпуск 0-9

УКАЗАНИЯ ПО ПОДБОРУ ЭЛЕМЕНТОВ КАРКАСА.

(Вариант армирования изделий сталью классов Ат-IVС и Врп-I).

часть 2

СТР.12-239

Книга 1

СТР.(112-175)

НАЧАЛО

24 166-02

ЦЕНА 9-88

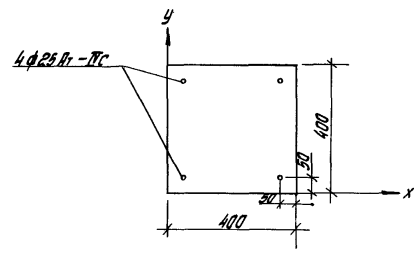

Бетон класса В22,5 ($R_{B2} = 4,3 \text{ МПа}$ при учете $\gamma_{B2} = 1,10$)
 Сталь класса А1-III
 Код сечения -113а

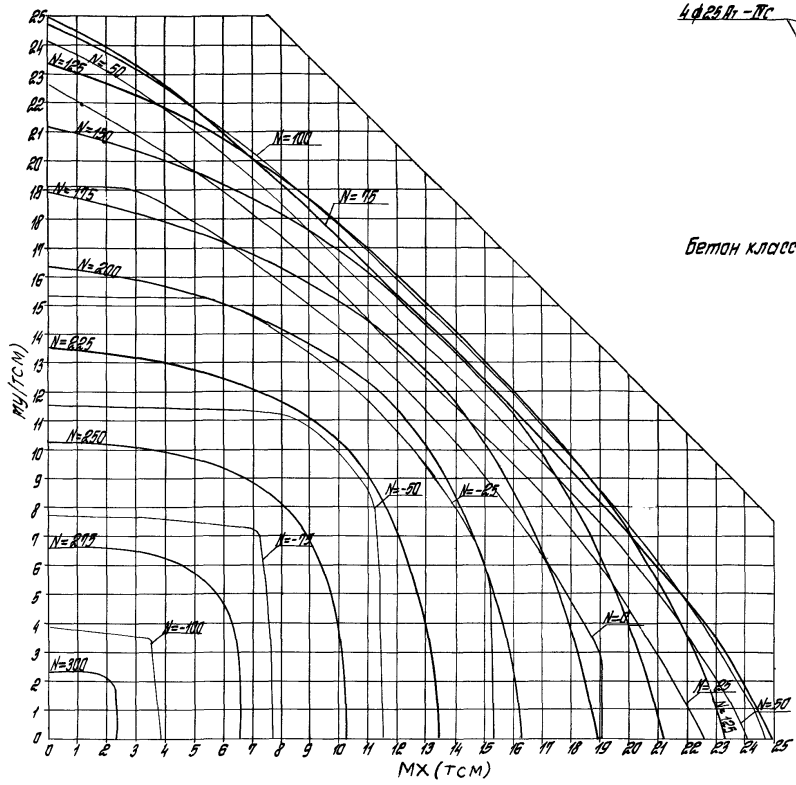

1.020.1-4 0-9 002

Лист	97
------	----

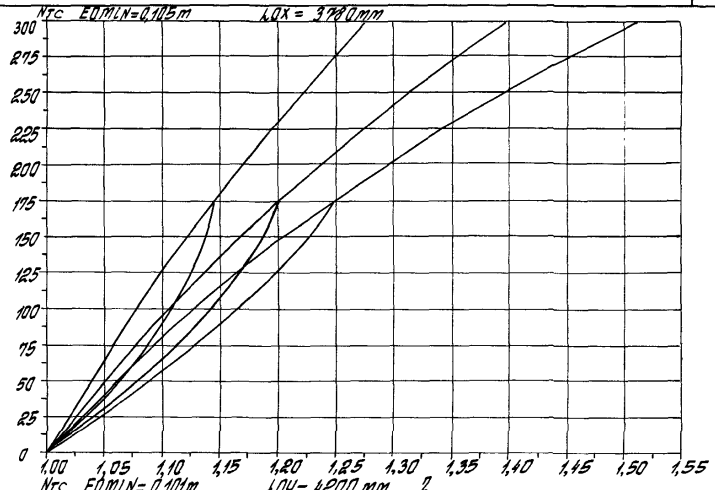
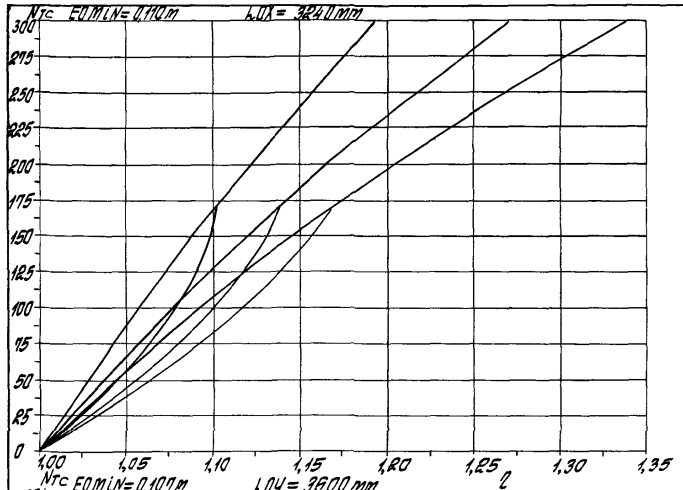

MATERIALES

1,3 1,4 1,5 1,6 1,7 1,8
 1,0 1,1 1,2
 1,020.1-4 0-9 002

INCH
98

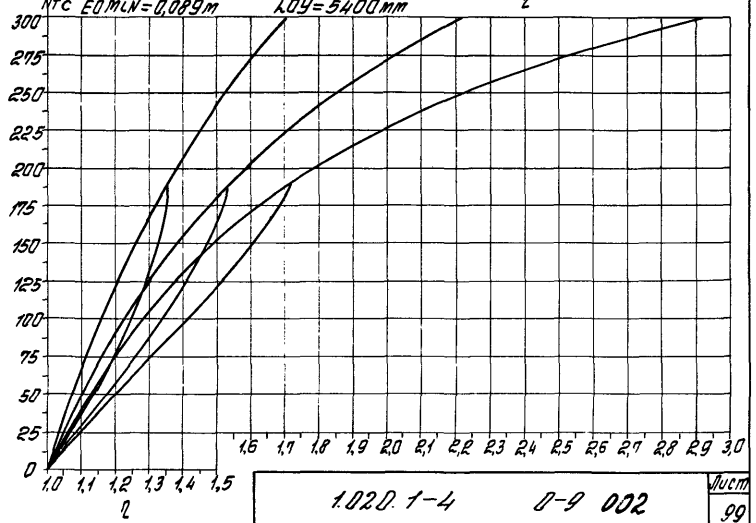
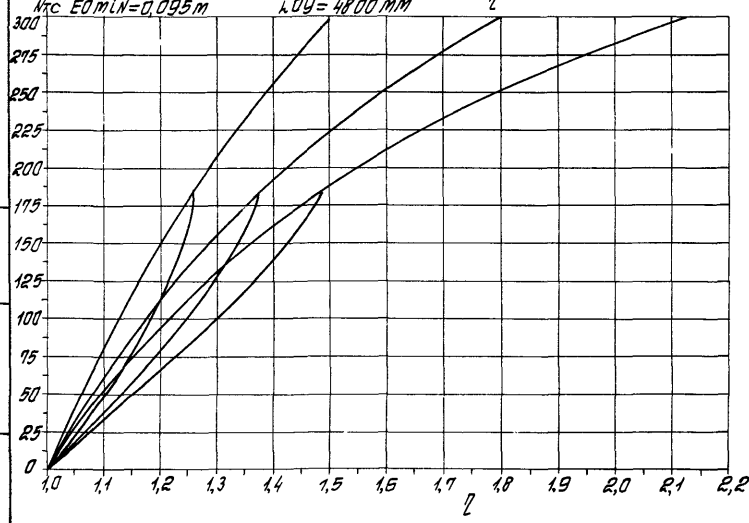
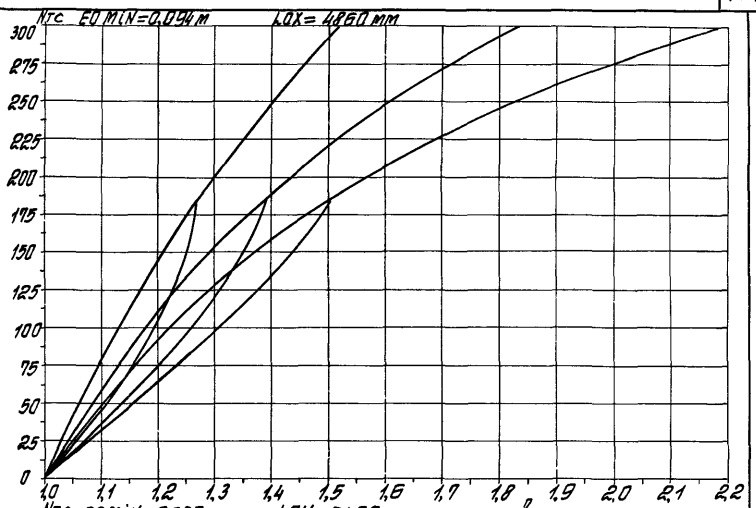
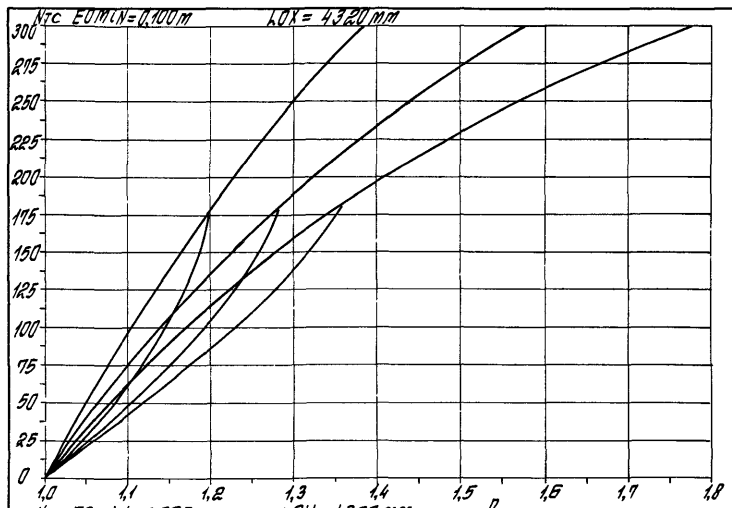

Умножить на коэффициент 1000

1.020.1-4 0-9 002

1/1000
99

ДИП. № 0004. Изобретение в области. Вязальн. мш. № 1

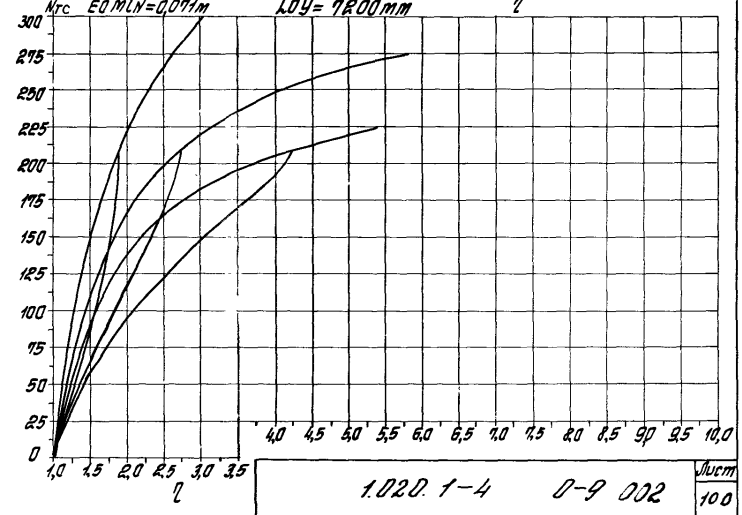
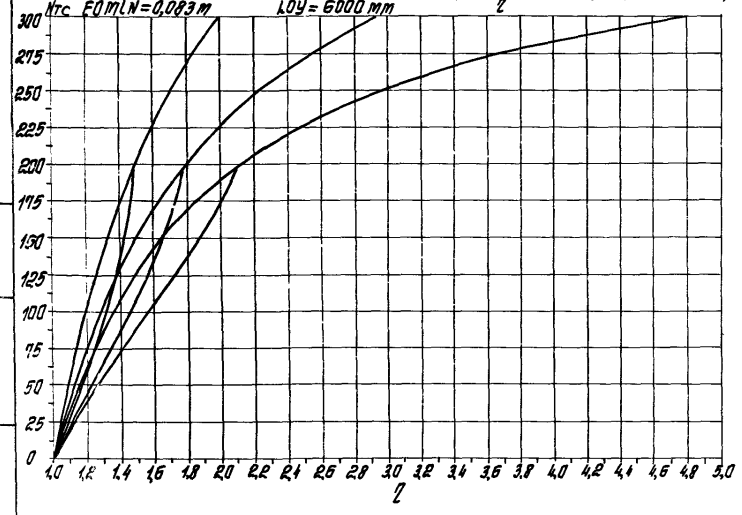
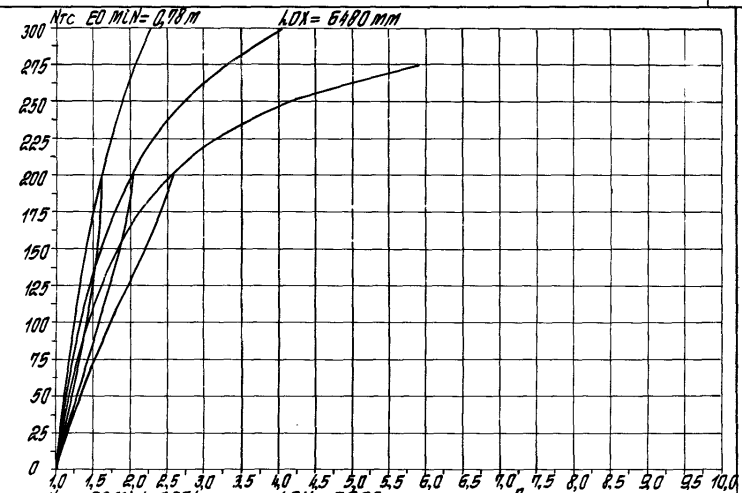
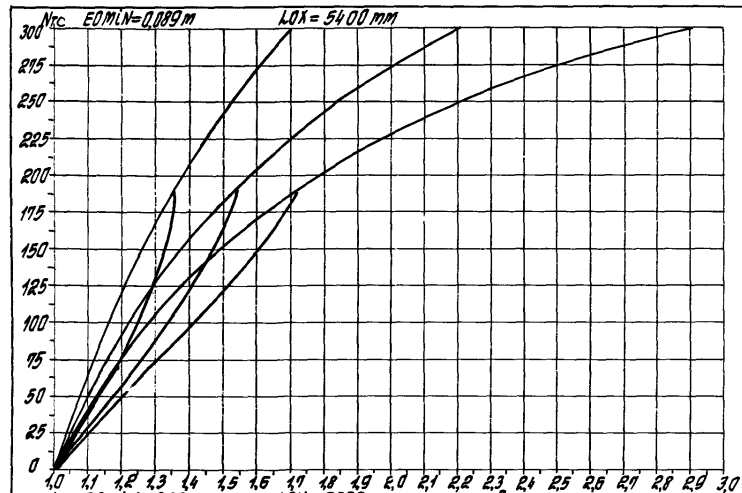

1020. 1-4 0-9 002 Шум 100

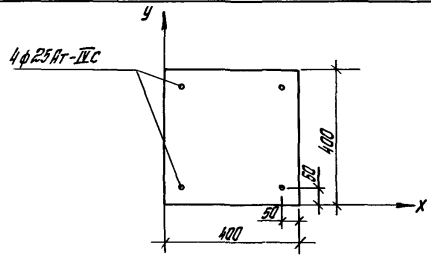
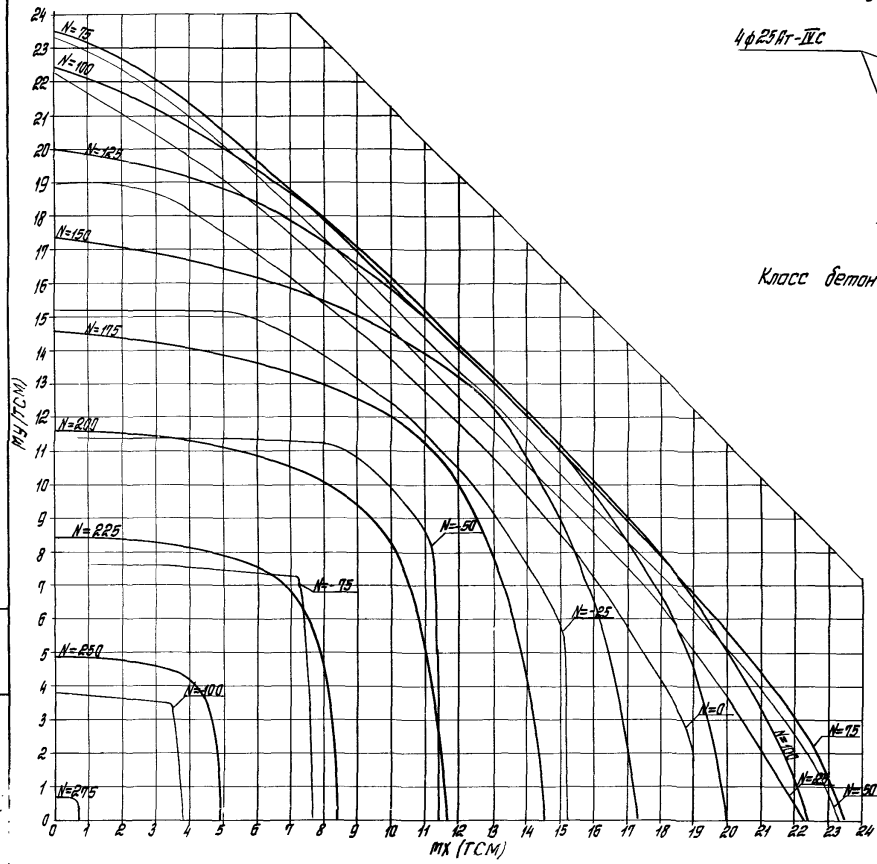

Класс бетона В=22,5 ($R_b = 11,7 \text{ МПа}$ при учете $\gamma_{b2} = 0,90$)
 Сталь АТ-ІІС
 Код сечения -1135

1.020. 1-4 0-9 002

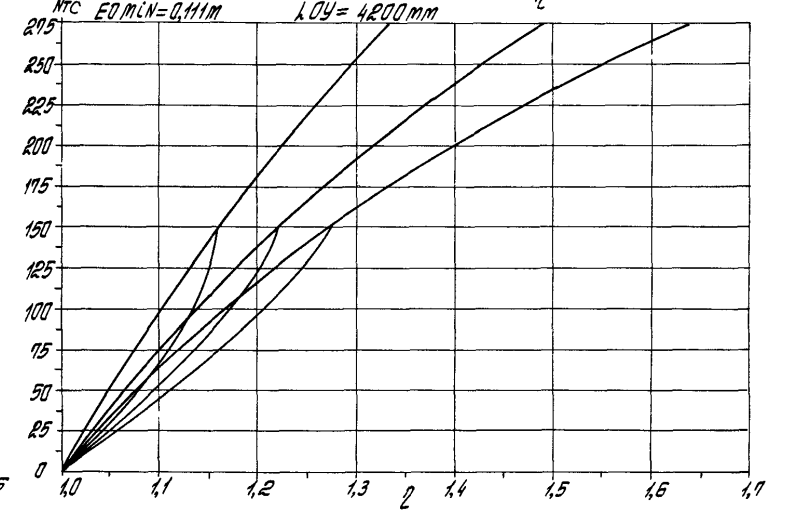
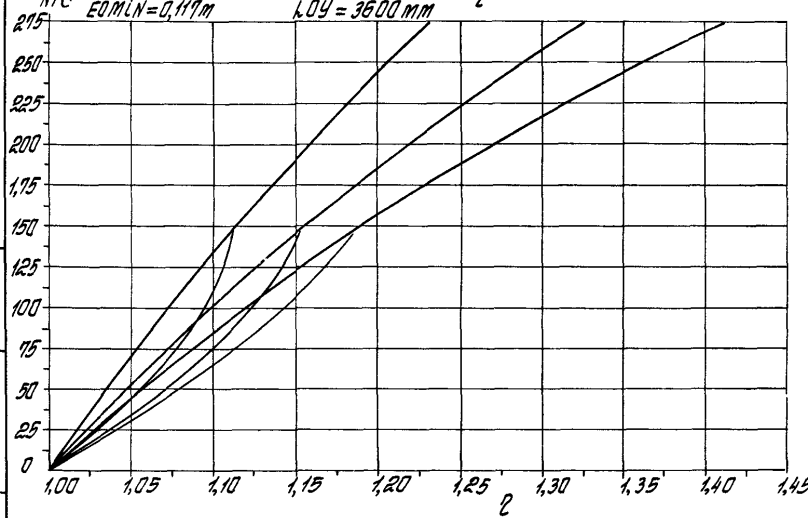
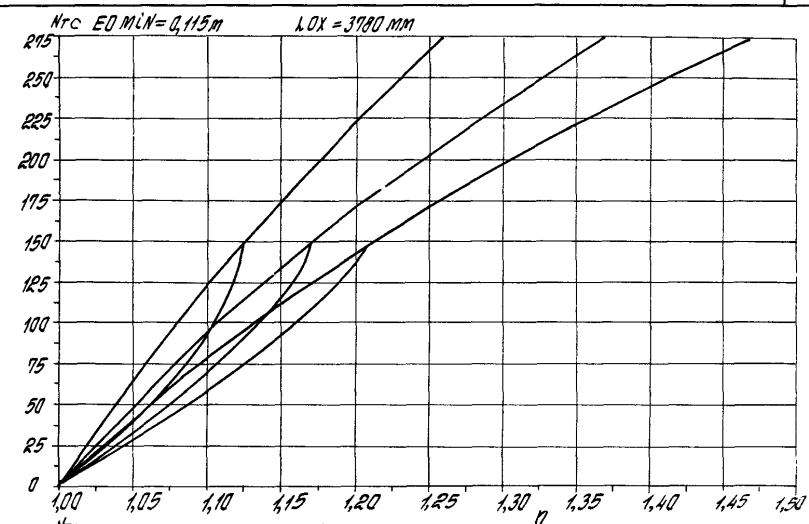
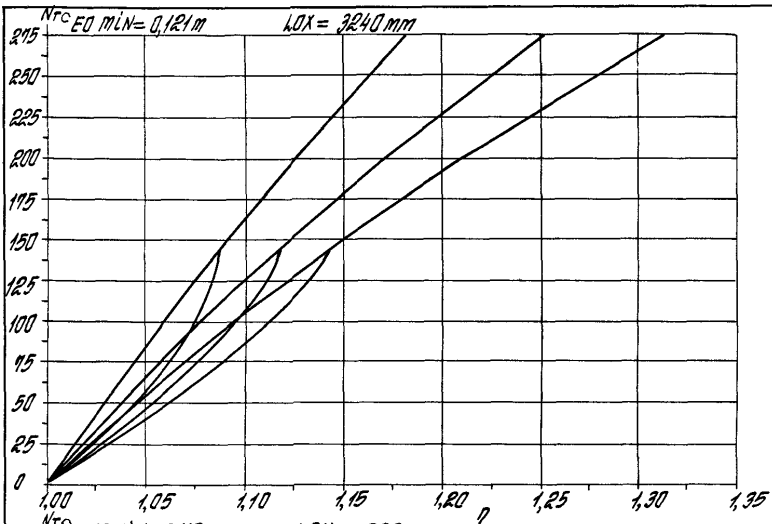

Чит. № 1022. Выпущено в свет 12.02.1952 г.

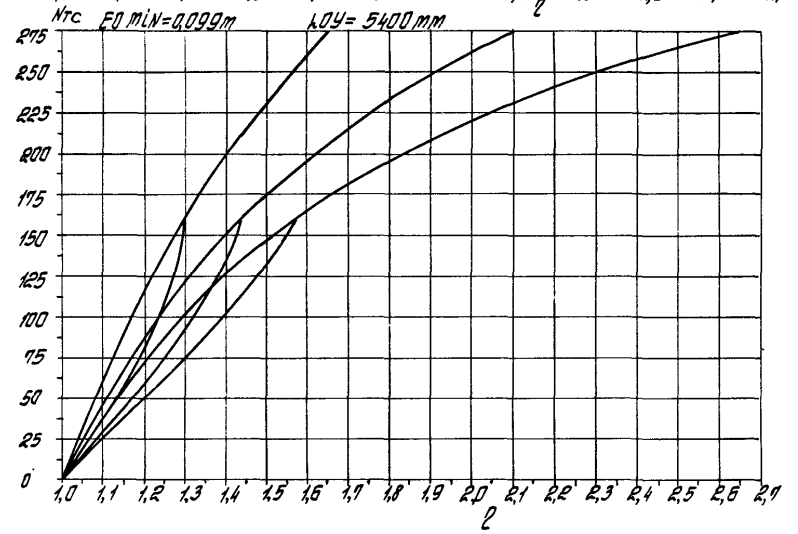
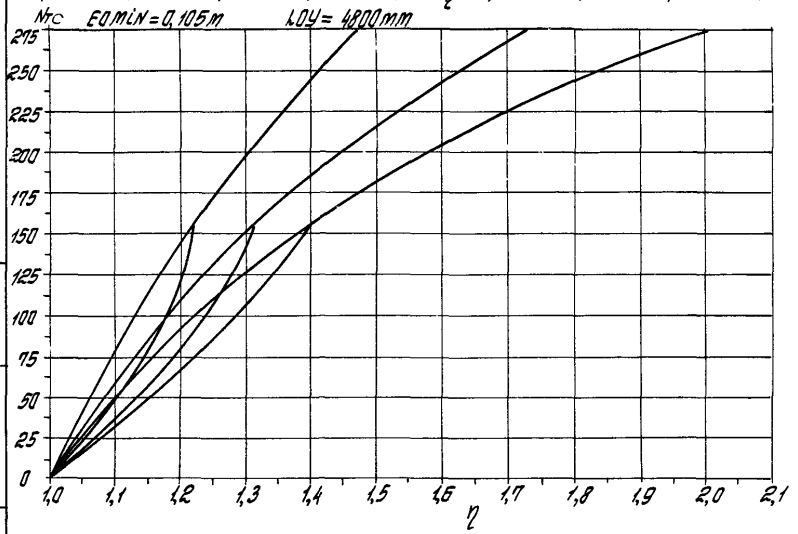
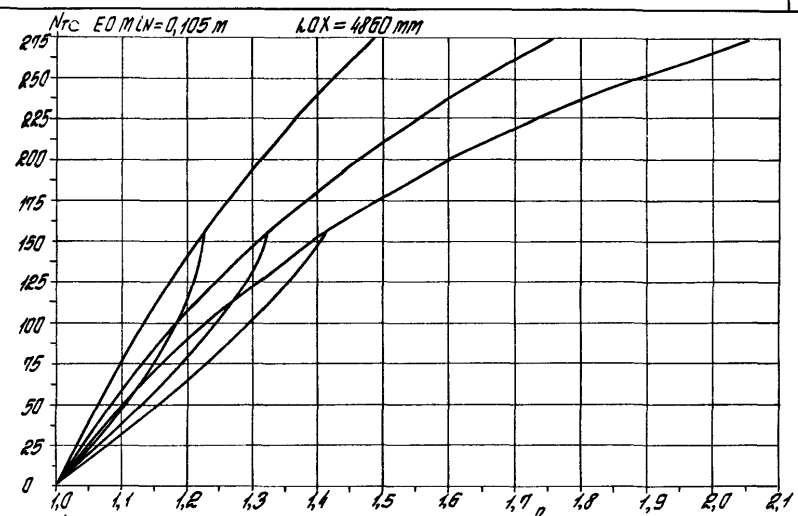
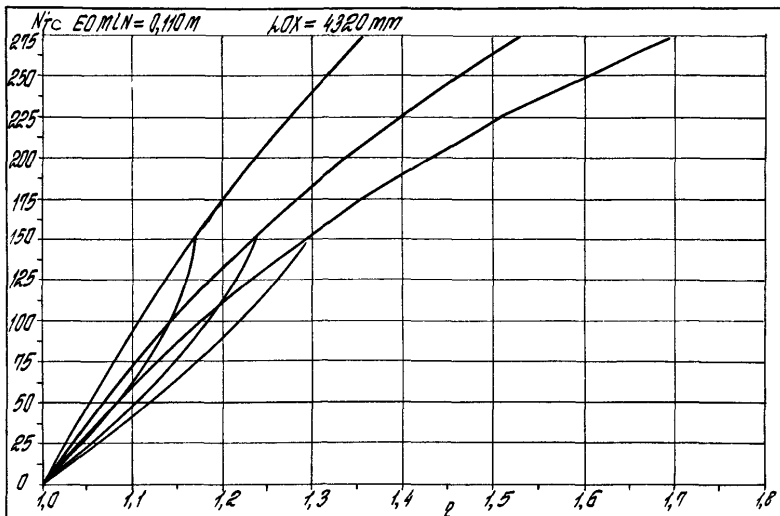

118
 103
 0-9
 1-4
 1020

1020. 1-4 0-9 002 103

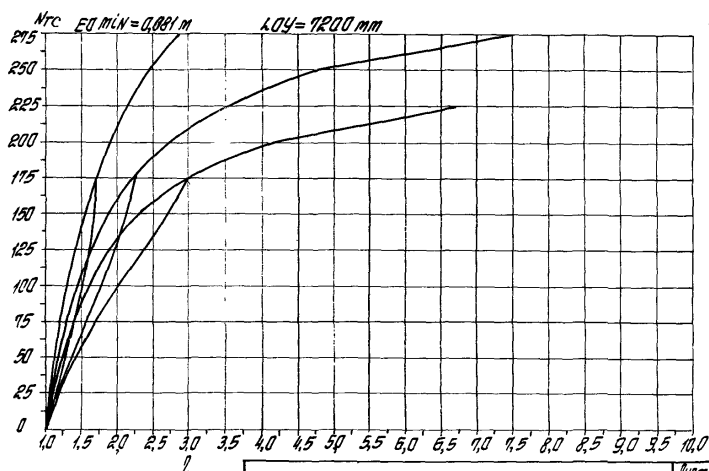
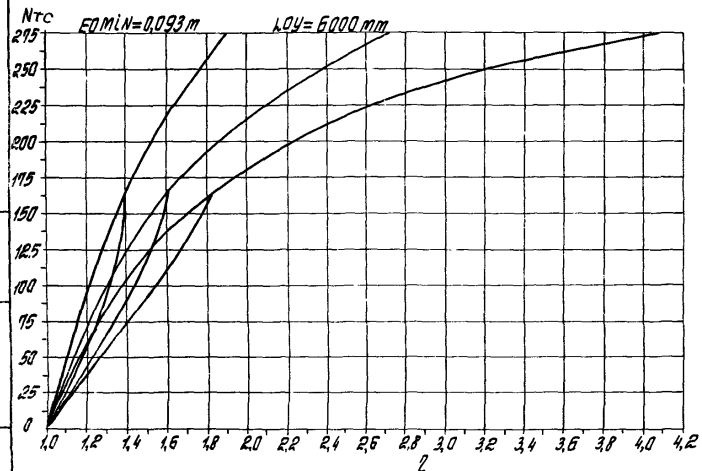
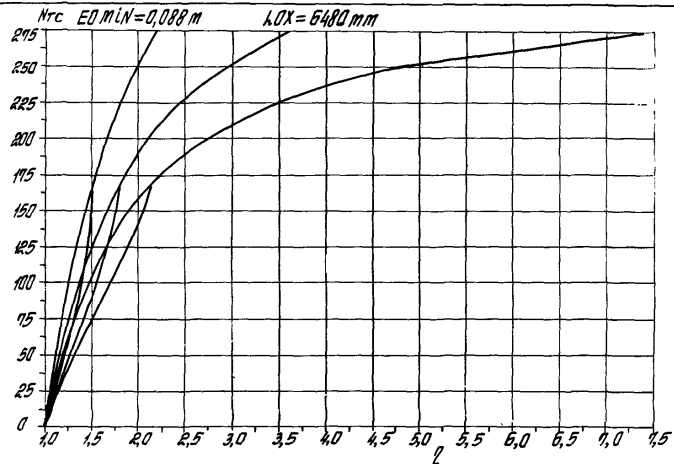
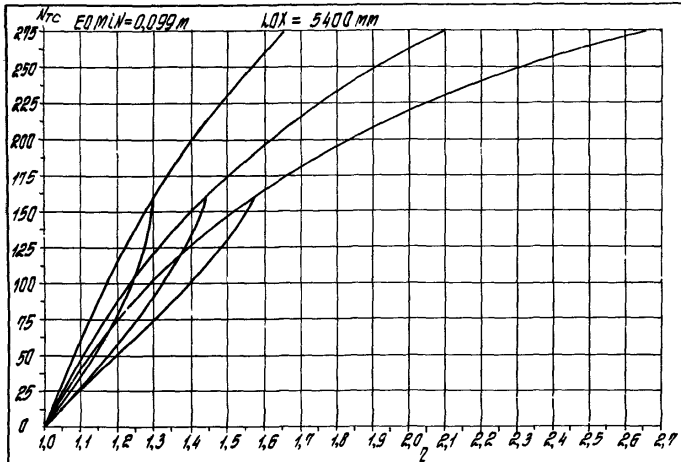

1.020.1-4

0-9 002

л/см
104

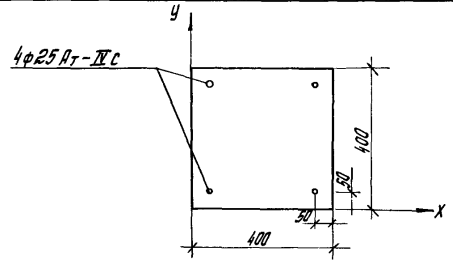

Класс бетона $B=30,0$ ($R_b=18,7$ МПа при учете $\gamma_{b2} = 1,10$)
 Сталь А7-II C
 Код сечения - 114a

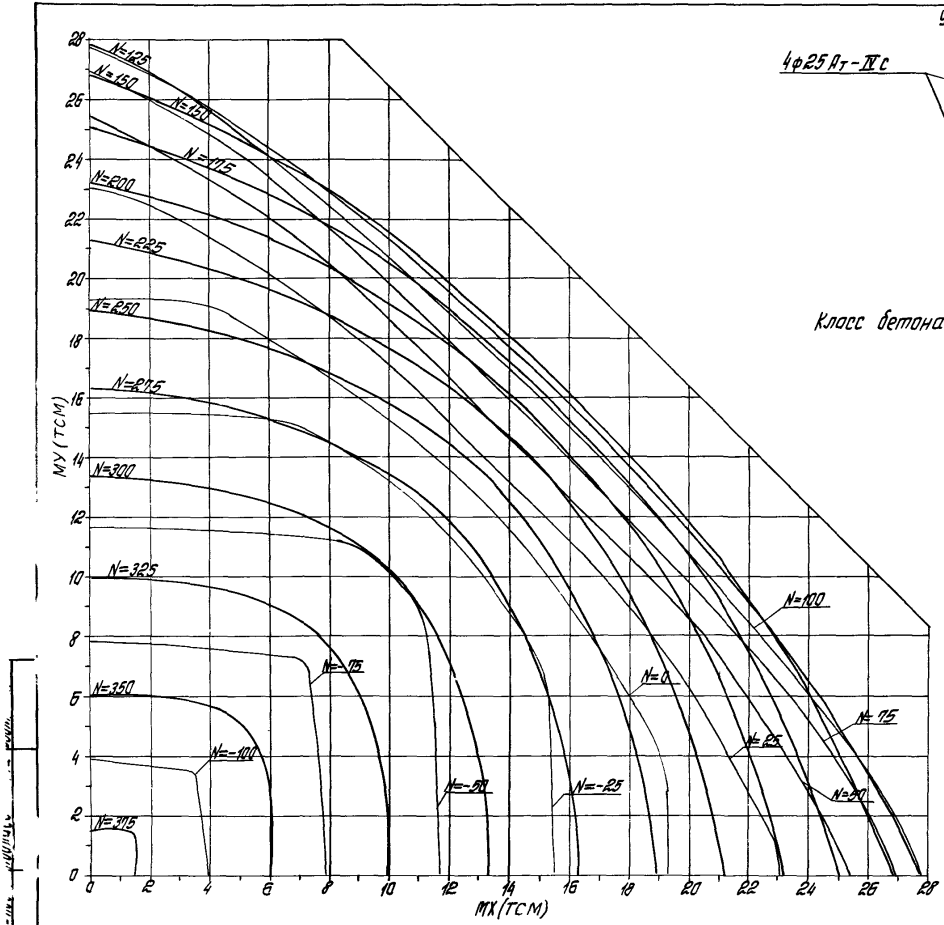

1.020. 1-4 0-9 002

Лист	5
------	---

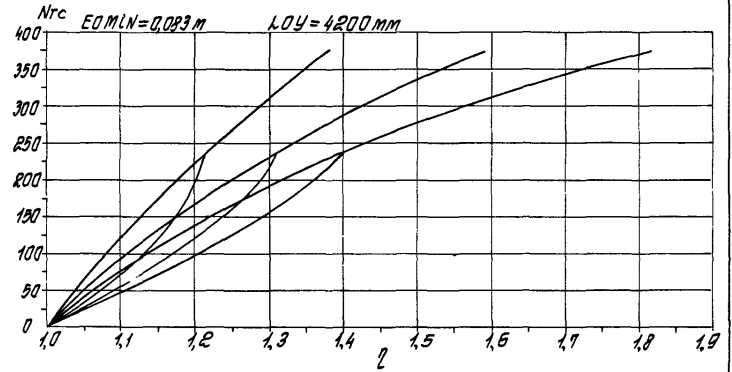
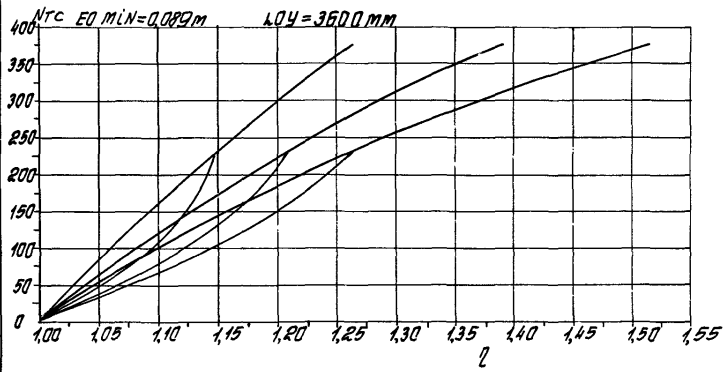
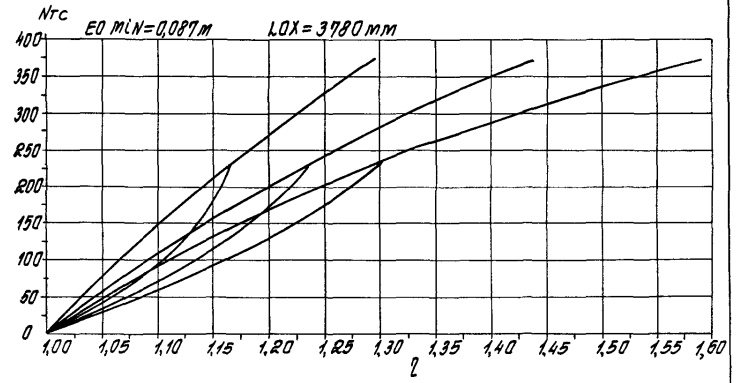
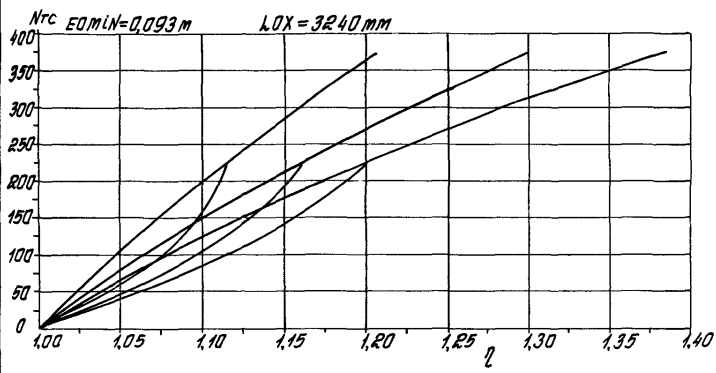

МАН. № 1000. 1. ПОЛУЧЕН В ЦЕНТРАЛНОМ УРЕДУ.

1.020. 1-4	0-9 032	Лист 106
------------	---------	-------------

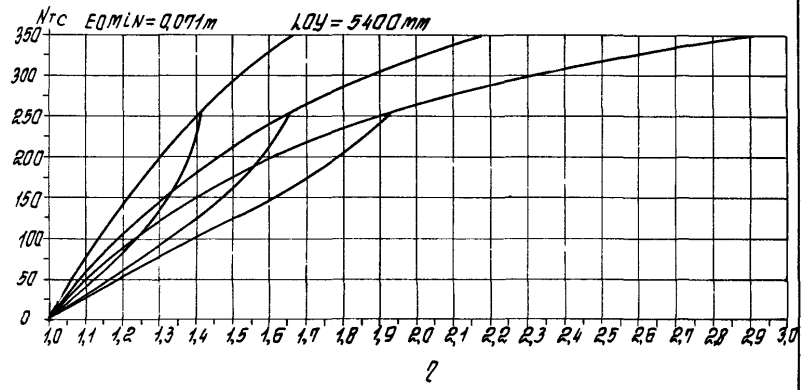
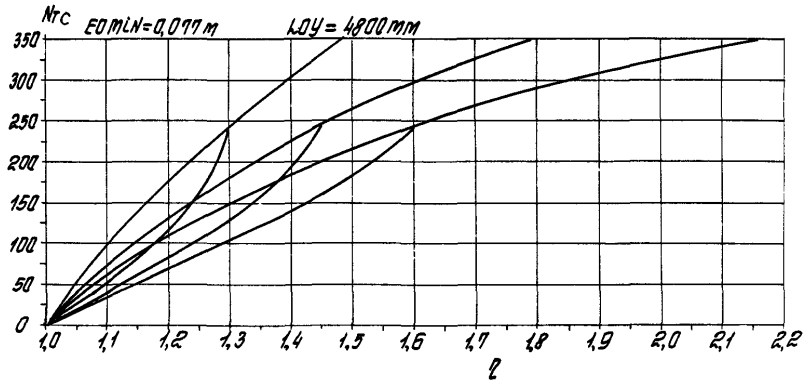
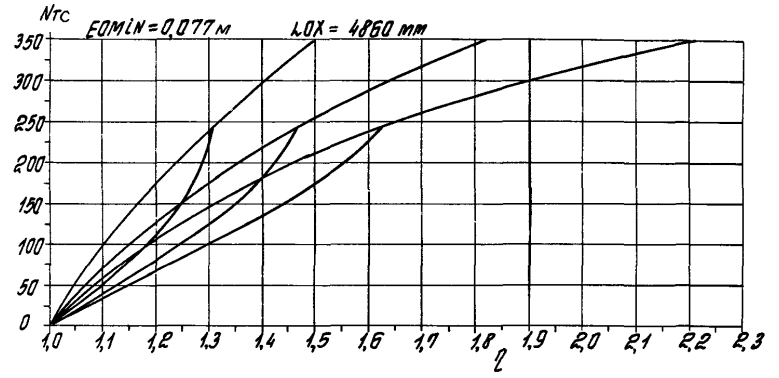
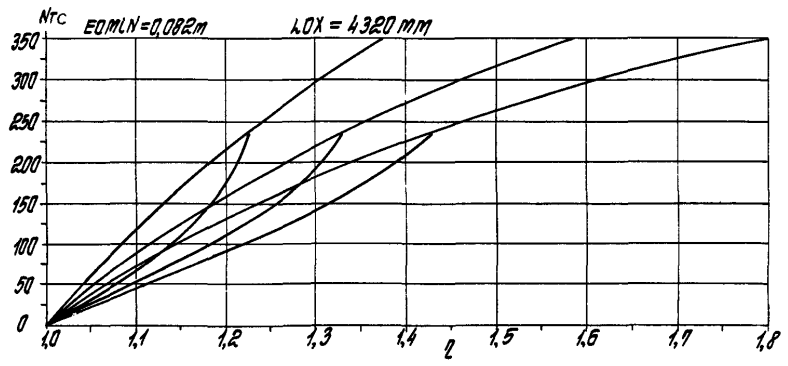

УКАЗ. ПО ПОЛОЖ. ПОДПИСАНО В ДОК. ВЕРИМ. УКАЗ. НА

1.020. 1-4 0-9 002 N_{rc}
107

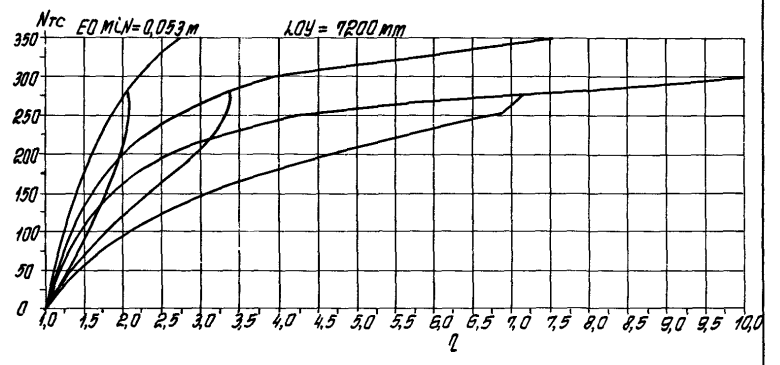
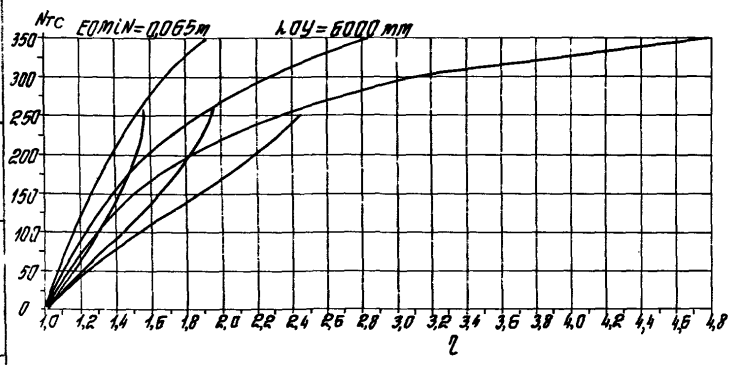
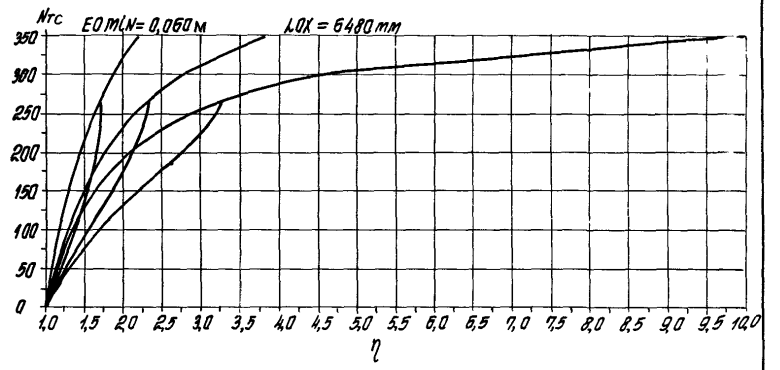
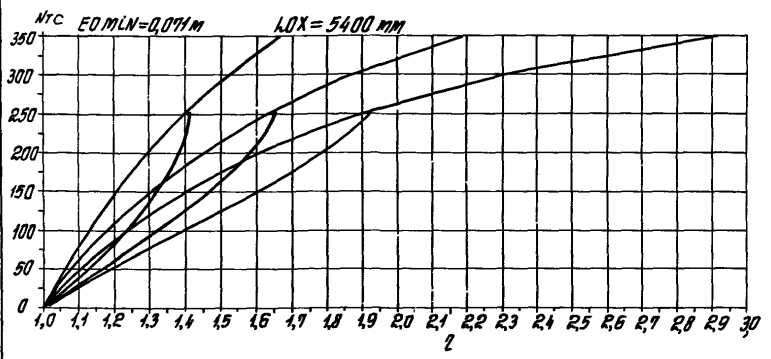

УЧБ № 10004 УЛУЧШАЮЩАЯ ПЛОЩАДЬ ПОДЪЕЗДА

1.020. 1-4 0-9 502 108

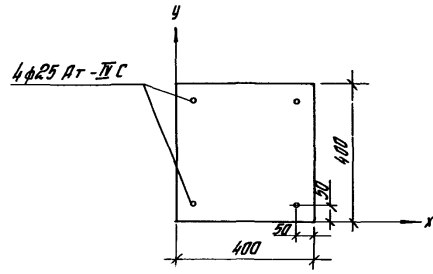

Класс бетона В30.0 ($R_b = 15.3 \text{ МПа}$ при учете $\gamma_{R2} = 0.90$)
 Сталь класса Аγ-II C
 Код сечения - 114б

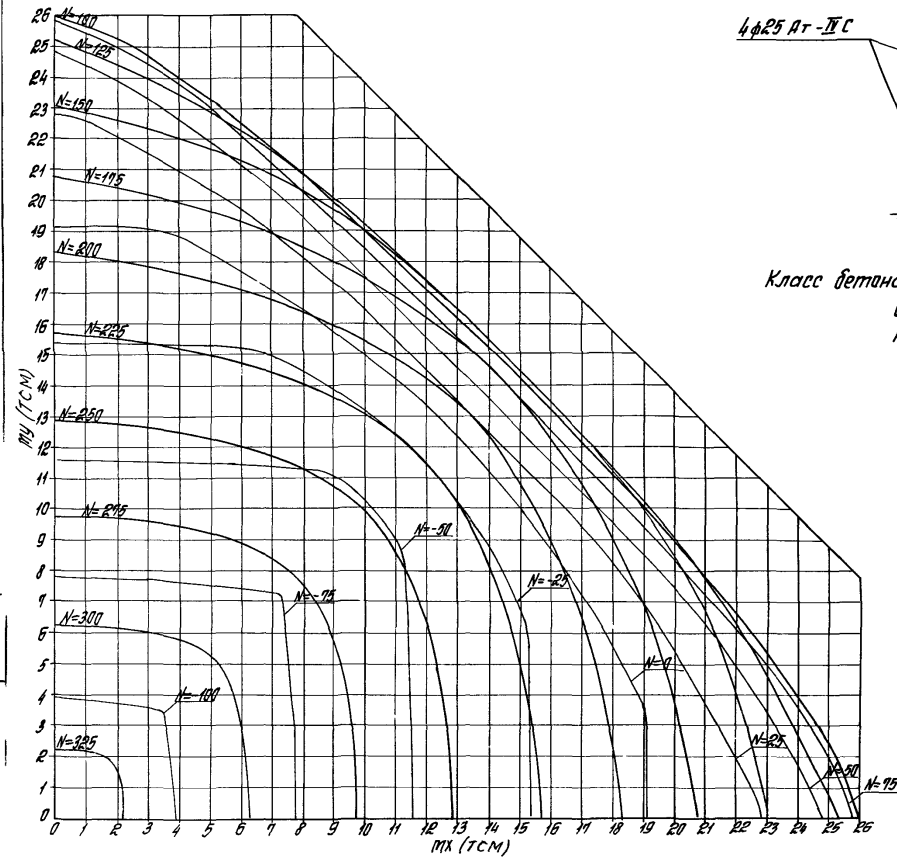

1.020.1-4 0-9 002

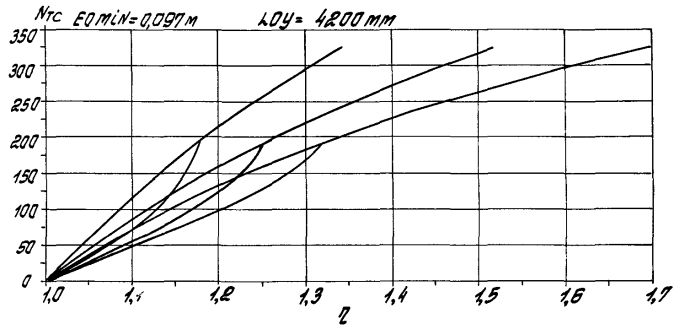
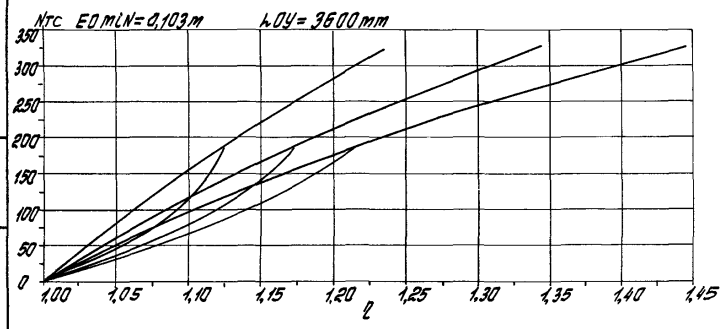
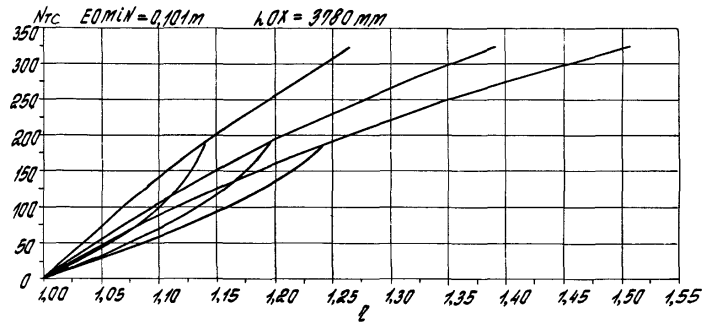
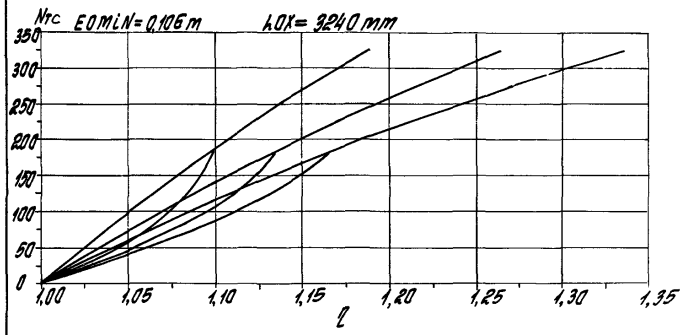

1.10.11.12.13.14.15.16.17.18.19.20.21.22.23.24.25.26.27.28.29.30.31.32.33.34.35.36.37.38.39.40.41.42.43.44.45.46.47.48.49.50.51.52.53.54.55.56.57.58.59.60.61.62.63.64.65.66.67.68.69.70.71.72.73.74.75.76.77.78.79.80.81.82.83.84.85.86.87.88.89.90.91.92.93.94.95.96.97.98.99.100.101.102.103.104.105.106.107.108.109.110.111.112.113.114.115.116.117.118.119.120.121.122.123.124.125.126.127.128.129.130.131.132.133.134.135.136.137.138.139.140.141.142.143.144.145.146.147.148.149.150.151.152.153.154.155.156.157.158.159.160.161.162.163.164.165.166.167.168.169.170.171.172.173.174.175.176.177.178.179.180.181.182.183.184.185.186.187.188.189.190.191.192.193.194.195.196.197.198.199.200.201.202.203.204.205.206.207.208.209.210.211.212.213.214.215.216.217.218.219.220.221.222.223.224.225.226.227.228.229.230.231.232.233.234.235.236.237.238.239.240.241.242.243.244.245.246.247.248.249.250.251.252.253.254.255.256.257.258.259.260.261.262.263.264.265.266.267.268.269.270.271.272.273.274.275.276.277.278.279.280.281.282.283.284.285.286.287.288.289.290.291.292.293.294.295.296.297.298.299.300.301.302.303.304.305.306.307.308.309.310.311.312.313.314.315.316.317.318.319.320.321.322.323.324.325.326.327.328.329.330.331.332.333.334.335.336.337.338.339.340.341.342.343.344.345.346.347.348.349.350.351.352.353.354.355.356.357.358.359.360.361.362.363.364.365.366.367.368.369.370.371.372.373.374.375.376.377.378.379.380.381.382.383.384.385.386.387.388.389.390.391.392.393.394.395.396.397.398.399.400.401.402.403.404.405.406.407.408.409.410.411.412.413.414.415.416.417.418.419.420.421.422.423.424.425.426.427.428.429.430.431.432.433.434.435.436.437.438.439.440.441.442.443.444.445.446.447.448.449.450.451.452.453.454.455.456.457.458.459.460.461.462.463.464.465.466.467.468.469.470.471.472.473.474.475.476.477.478.479.480.481.482.483.484.485.486.487.488.489.490.491.492.493.494.495.496.497.498.499.500.501.502.503.504.505.506.507.508.509.510.511.512.513.514.515.516.517.518.519.520.521.522.523.524.525.526.527.528.529.530.531.532.533.534.535.536.537.538.539.540.541.542.543.544.545.546.547.548.549.550.551.552.553.554.555.556.557.558.559.560.561.562.563.564.565.566.567.568.569.570.571.572.573.574.575.576.577.578.579.580.581.582.583.584.585.586.587.588.589.590.591.592.593.594.595.596.597.598.599.600.601.602.603.604.605.606.607.608.609.610.611.612.613.614.615.616.617.618.619.620.621.622.623.624.625.626.627.628.629.630.631.632.633.634.635.636.637.638.639.640.641.642.643.644.645.646.647.648.649.650.651.652.653.654.655.656.657.658.659.660.661.662.663.664.665.666.667.668.669.670.671.672.673.674.675.676.677.678.679.680.681.682.683.684.685.686.687.688.689.690.691.692.693.694.695.696.697.698.699.700.701.702.703.704.705.706.707.708.709.710.711.712.713.714.715.716.717.718.719.720.721.722.723.724.725.726.727.728.729.730.731.732.733.734.735.736.737.738.739.740.741.742.743.744.745.746.747.748.749.750.751.752.753.754.755.756.757.758.759.760.761.762.763.764.765.766.767.768.769.770.771.772.773.774.775.776.777.778.779.780.781.782.783.784.785.786.787.788.789.790.791.792.793.794.795.796.797.798.799.800.801.802.803.804.805.806.807.808.809.810.811.812.813.814.815.816.817.818.819.820.821.822.823.824.825.826.827.828.829.830.831.832.833.834.835.836.837.838.839.840.841.842.843.844.845.846.847.848.849.850.851.852.853.854.855.856.857.858.859.860.861.862.863.864.865.866.867.868.869.870.871.872.873.874.875.876.877.878.879.880.881.882.883.884.885.886.887.888.889.890.891.892.893.894.895.896.897.898.899.900.901.902.903.904.905.906.907.908.909.910.911.912.913.914.915.916.917.918.919.920.921.922.923.924.925.926.927.928.929.930.931.932.933.934.935.936.937.938.939.940.941.942.943.944.945.946.947.948.949.950.951.952.953.954.955.956.957.958.959.960.961.962.963.964.965.966.967.968.969.970.971.972.973.974.975.976.977.978.979.980.981.982.983.984.985.986.987.988.989.990.991.992.993.994.995.996.997.998.999.1000.

1.020.1-4 0-9 002 110

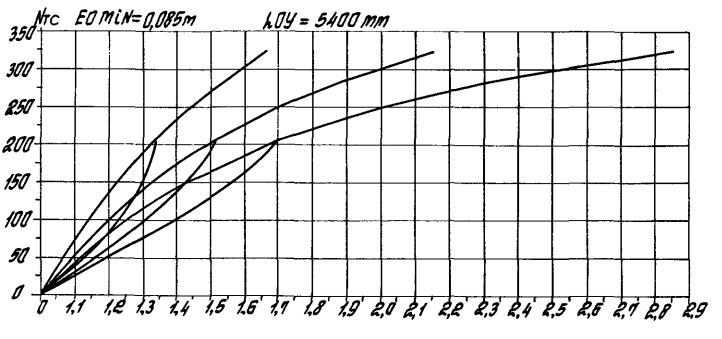
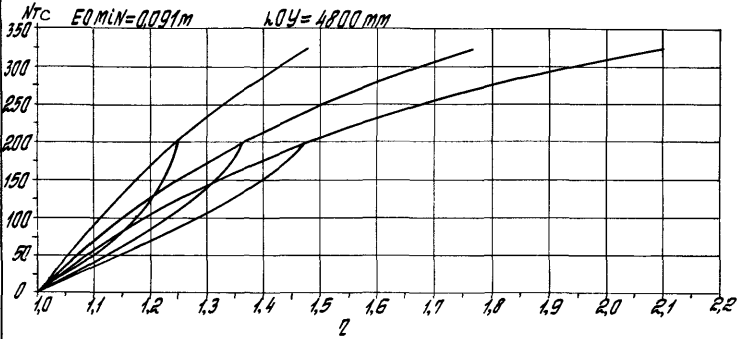
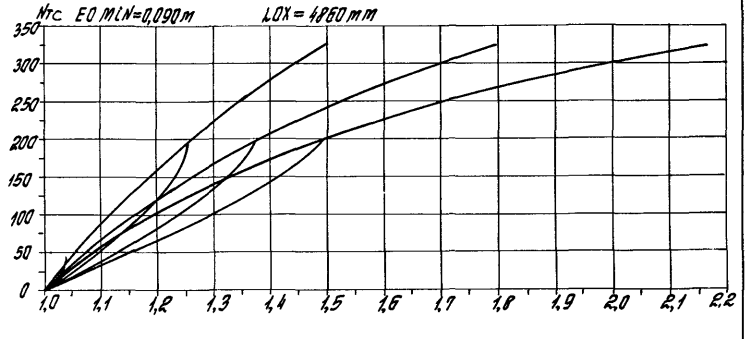
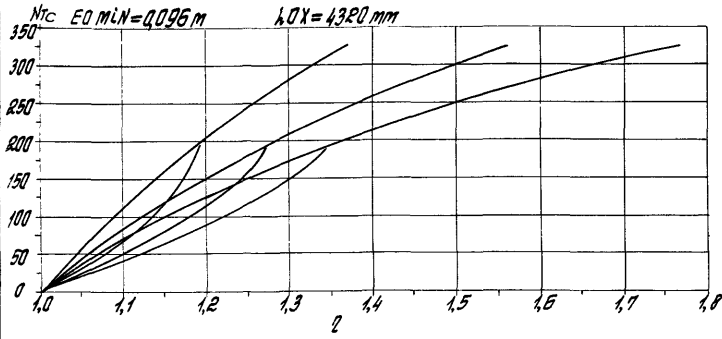

LIT. № 1000. М. 1958. 111 стр.

1.020.1-4 0-9 002	Лит 111
-------------------	------------

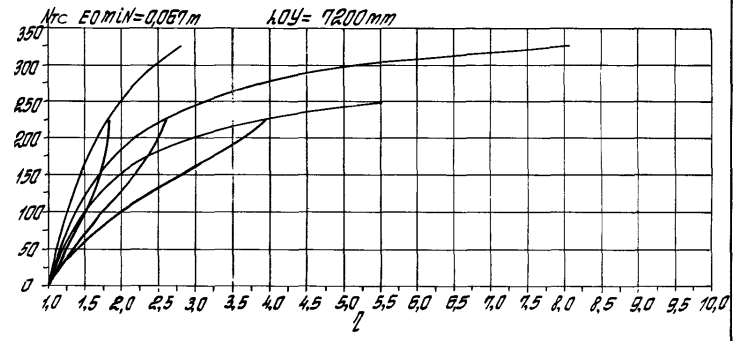
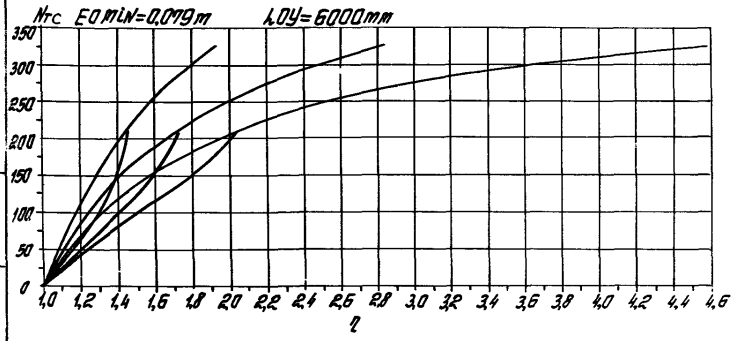
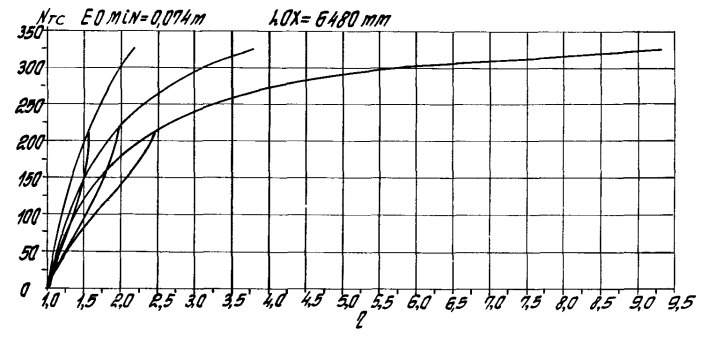
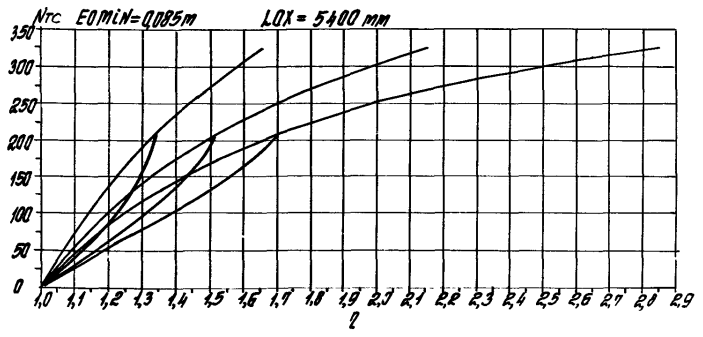

1.020.1-4 0-9 102

1.020.1-4 0-9 102	112
-------------------	-----

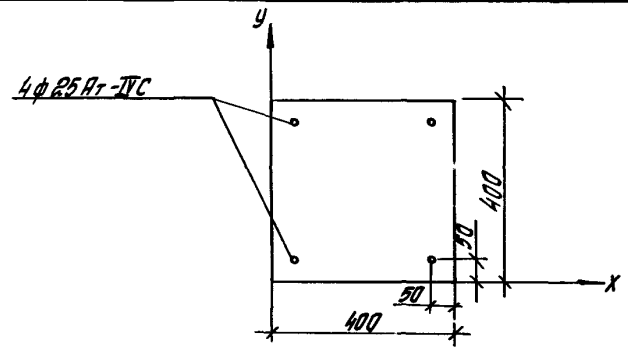
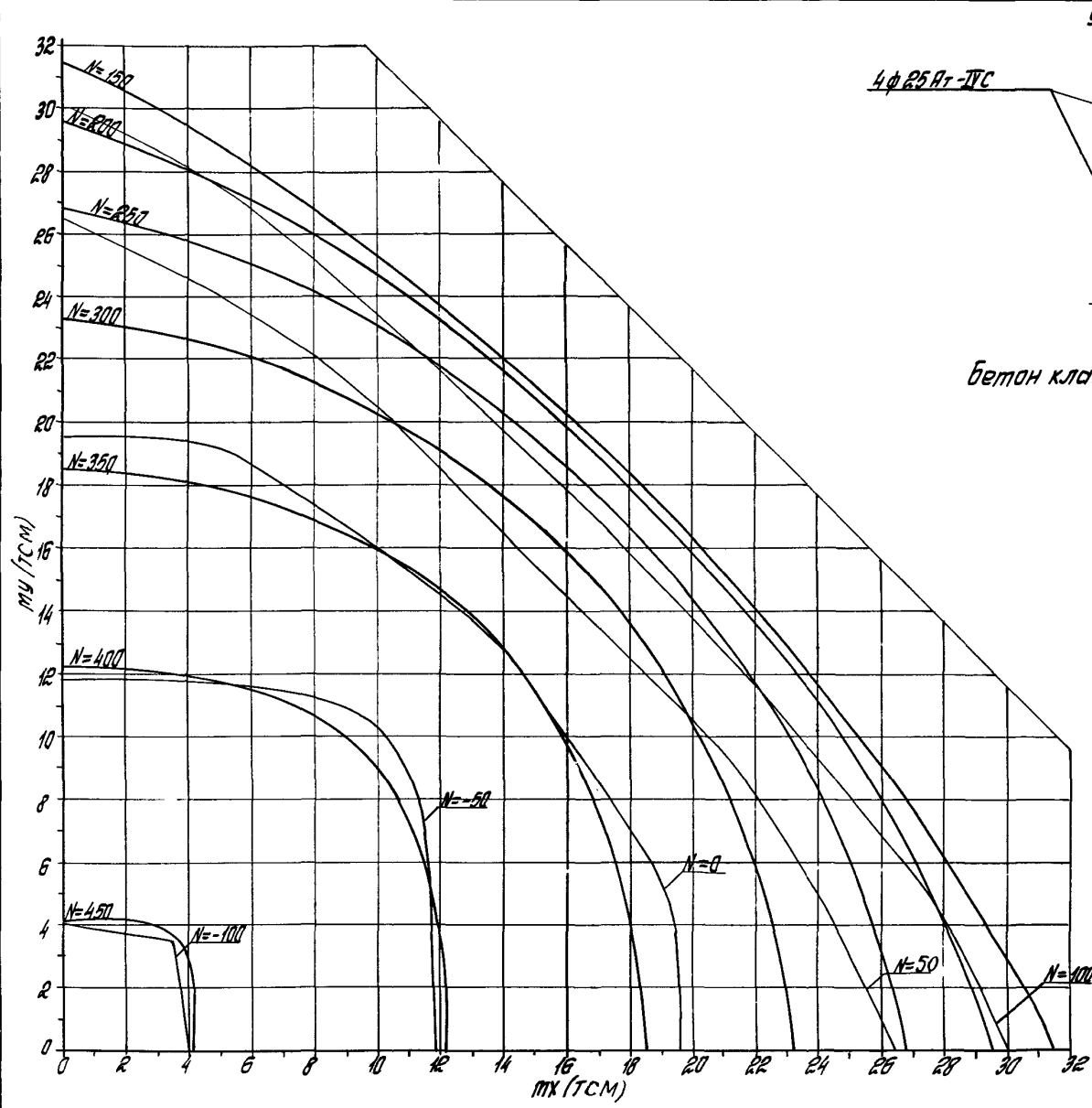

бетон класса В40.0 ($R_B = 24,2 \text{ МПа}$ при учете $\gamma_{B2} = 1,10$)
 Сталь класса А1-IVC
 Код сечения - 115а

ИСТОЧНИК: НИИЖЕИПРОЕКТИРОВАНИЕ И КОНСТРУКТИВНОЕ ПРОЕКТИРОВАНИЕ

1.020.1-4 0-9 002	Лист
	113

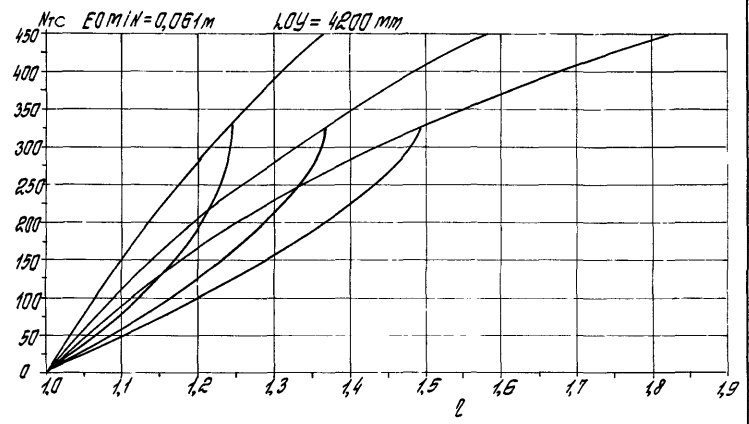
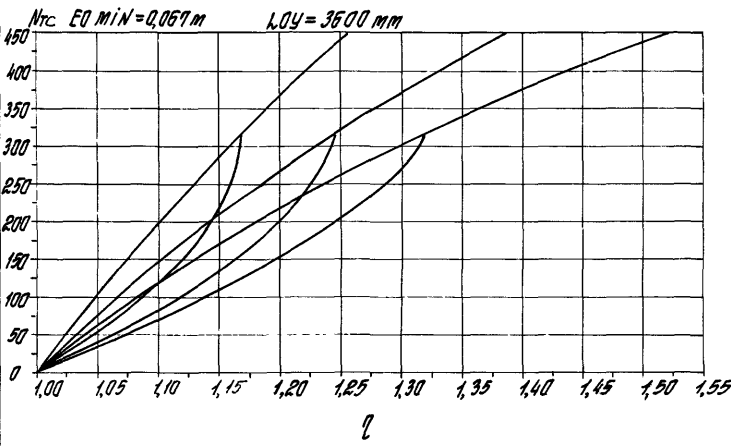
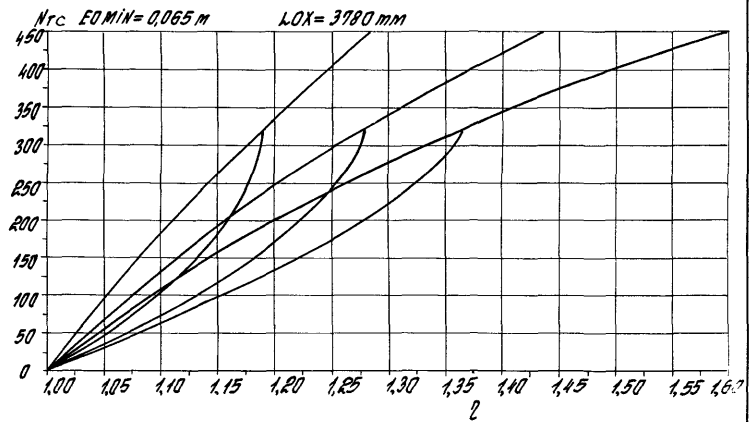
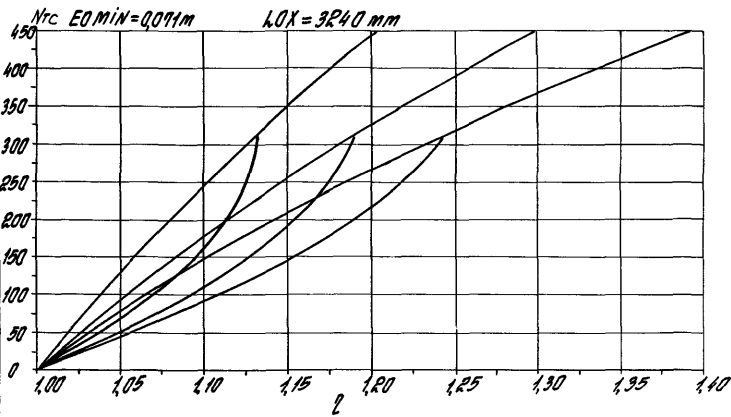

Unit: mm, min, max, mean, etc.

1.020.1-4 0-9 002

114

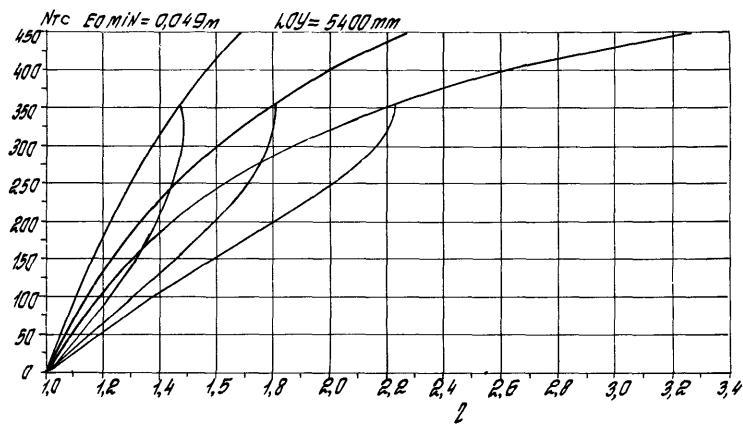
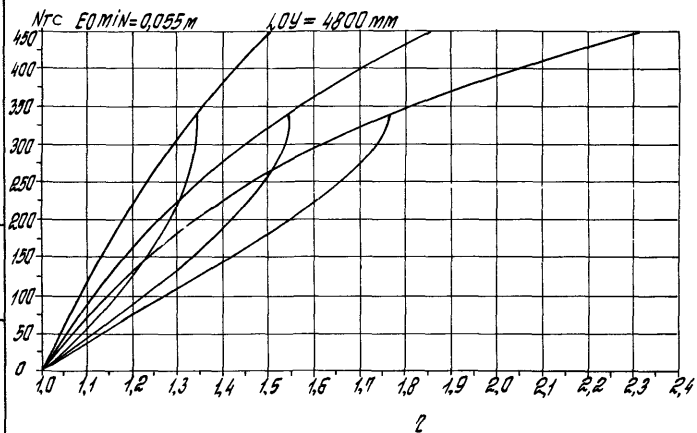
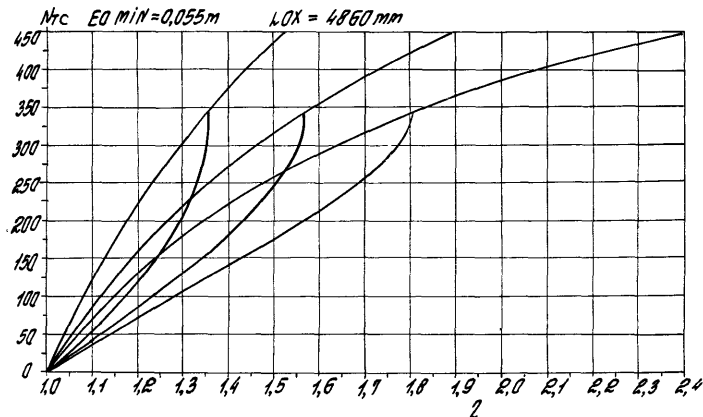
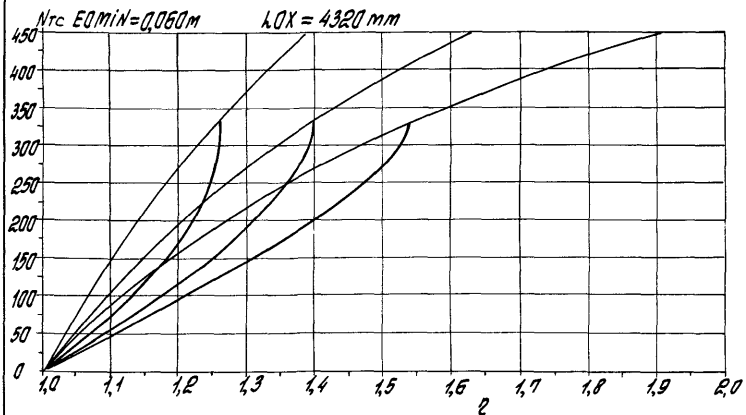

Учб. № 005-01. Издательство Учен. зап. кн.-б. Удмурт. ун-та. 2010 г.

1.020.1-4 0-9 01.2	Лист 115
--------------------	-------------

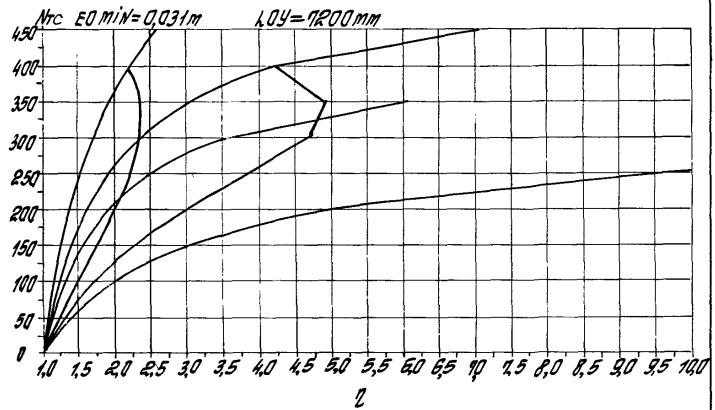
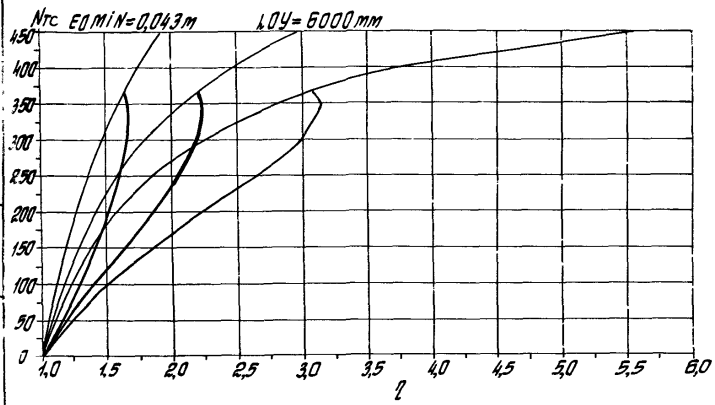
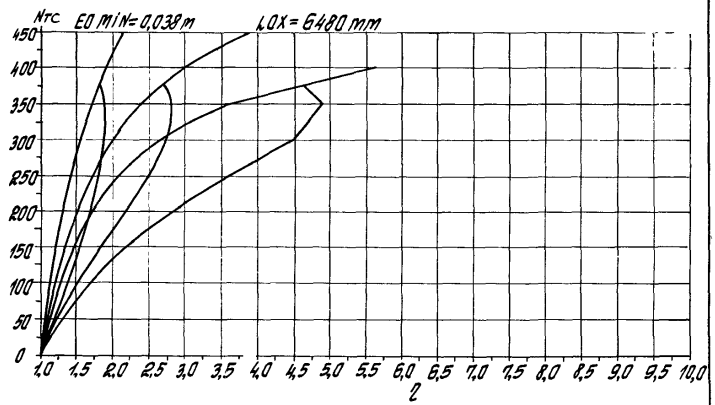
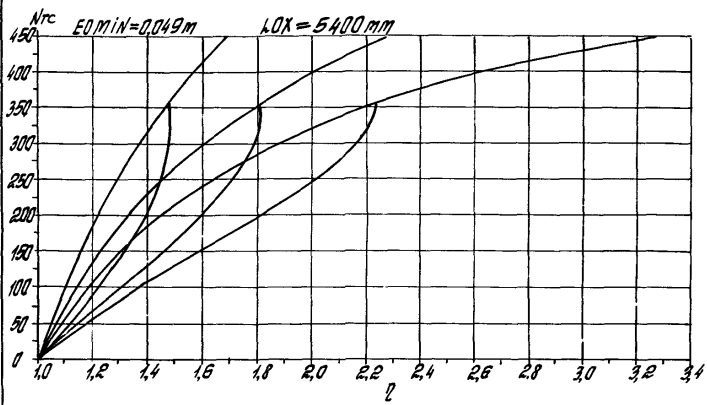

ВНИМАНИЕ! УКАЗАНИЕ НА СТРАНИЦЕ 116

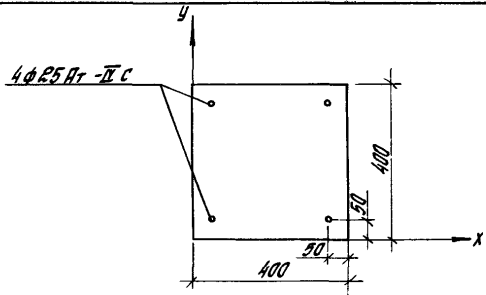

Класс бетона B40,0 ($R_b = 19,8$ МПа при учете $\gamma_{b2} = 0,90$)
 Сталь класса А7-IV c
 Код сечения - 1155

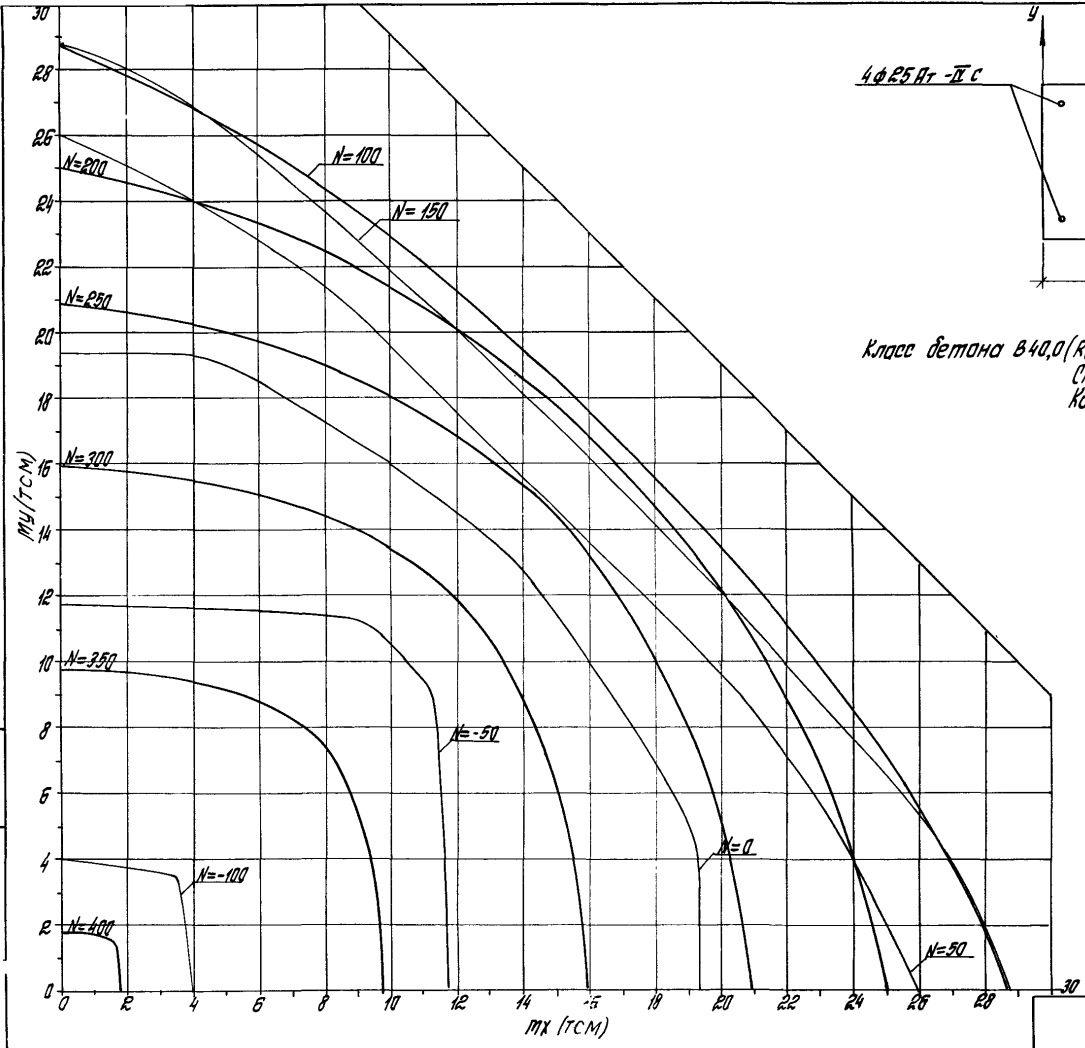

Интерпретация результатов расчета в соответствии с требованиями СНиП 52-01-2003

1.020.1-4-0-9 002

Лист 117

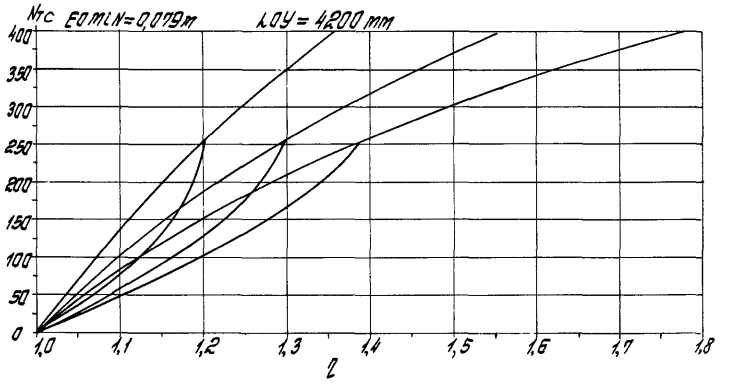
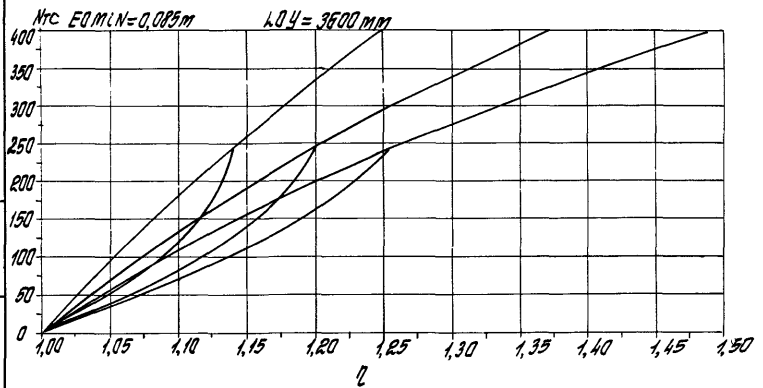
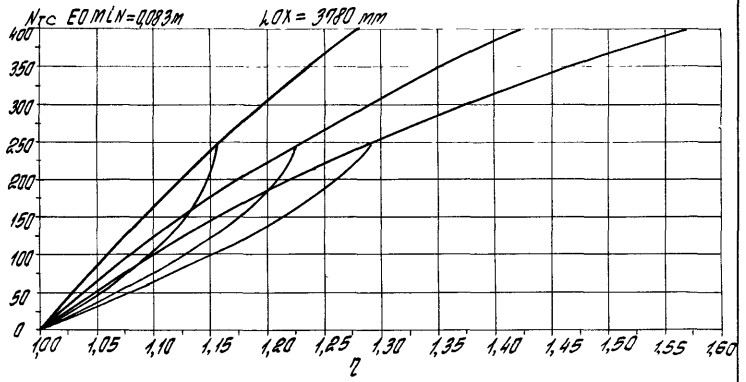
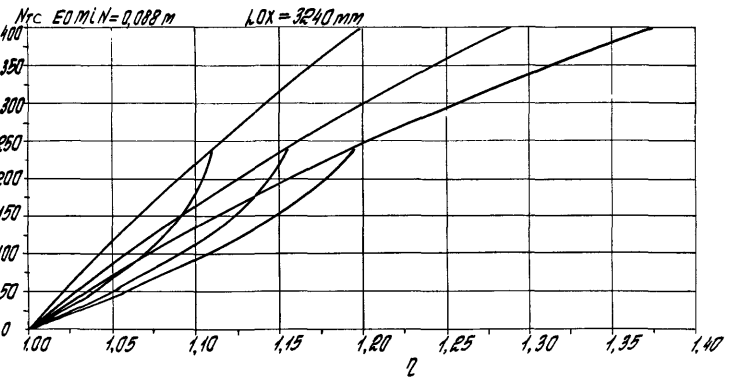

УЧЕТЪТ НА ПЛОЩТА НА ПОПРЕЧНОТО СЪДИЩЕ

1.020.1-4 0-9 002	Лист 118
-------------------	-------------

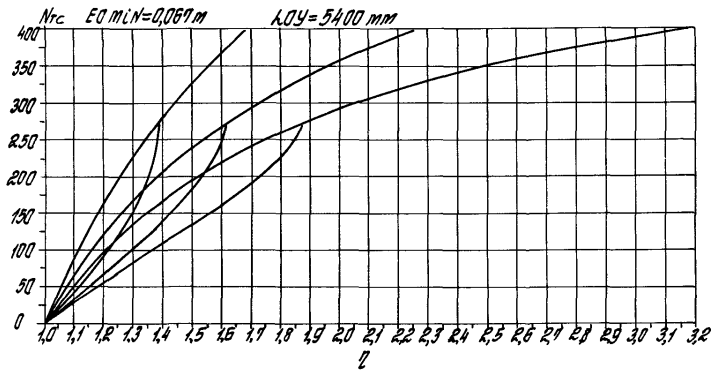
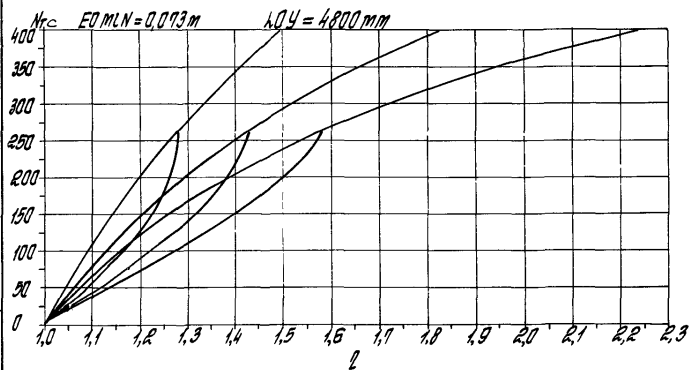
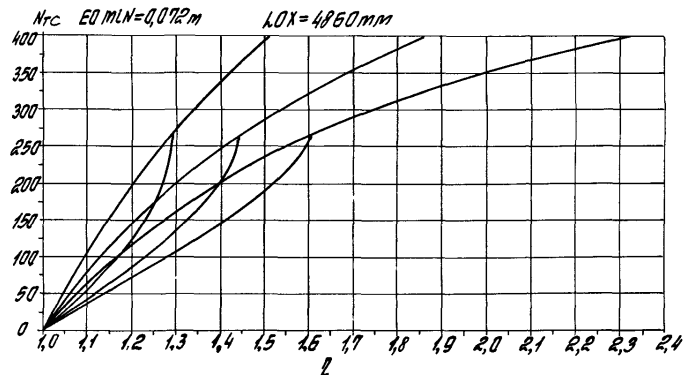
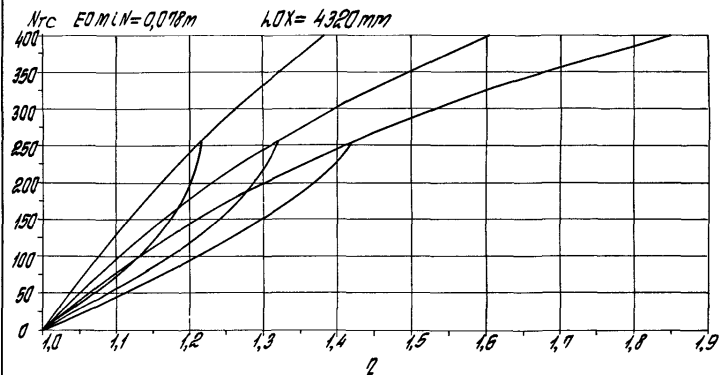

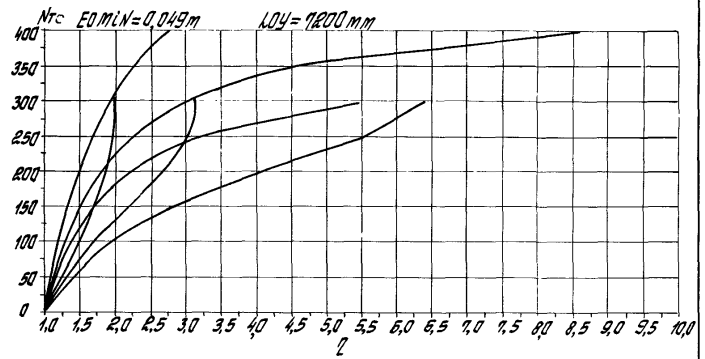
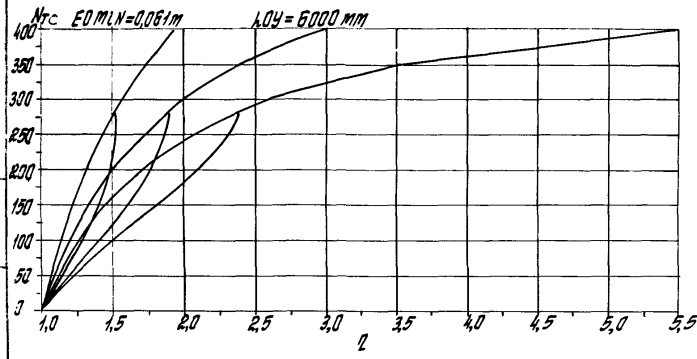
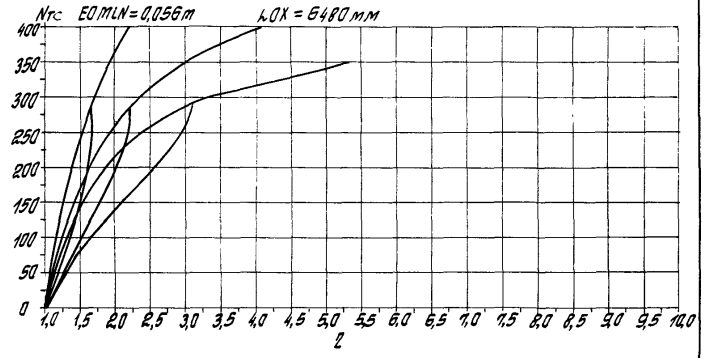
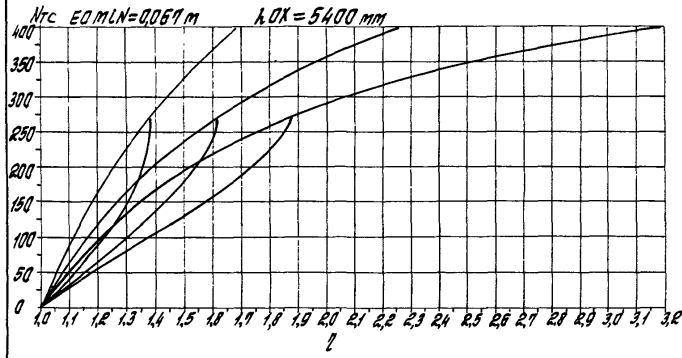

1.020.1-4 7-9 002
 120mm

1.020.1-4 7-9 002 120mm

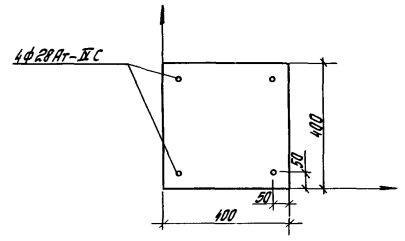
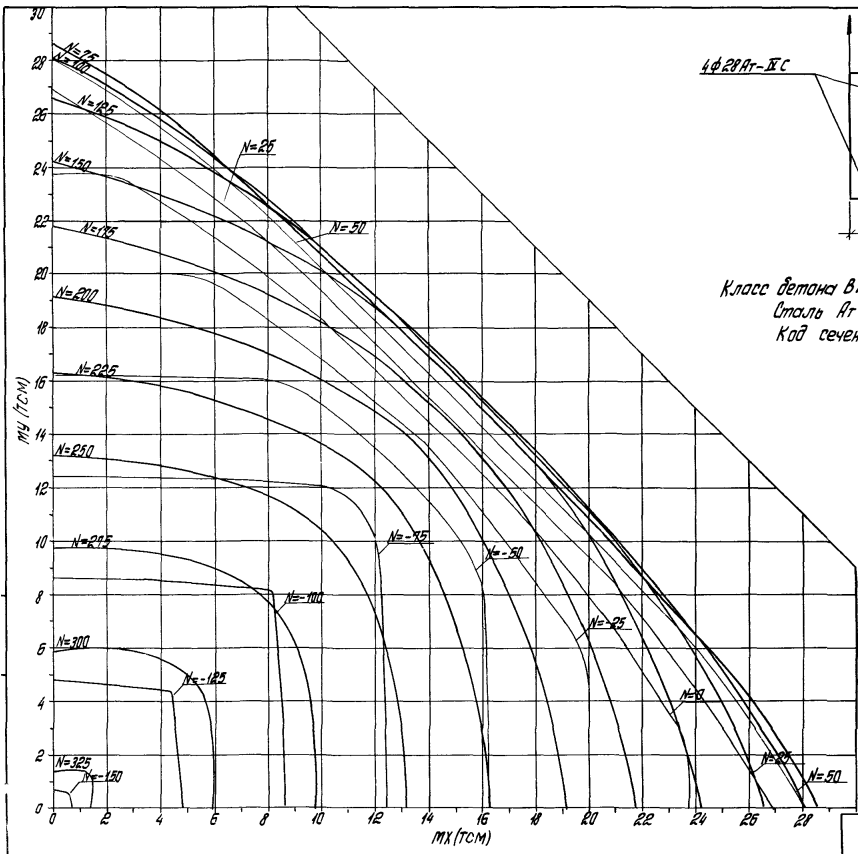

Класс бетона В22,5 ($R_b = 14,3 \text{ МПа}$ при учете $\gamma_{b2} = 1,10$)
 Сталь Ат-ІІС
 Код сечения - 116а

1020 1-4	0-9 002	Масш 1:21
----------	---------	--------------

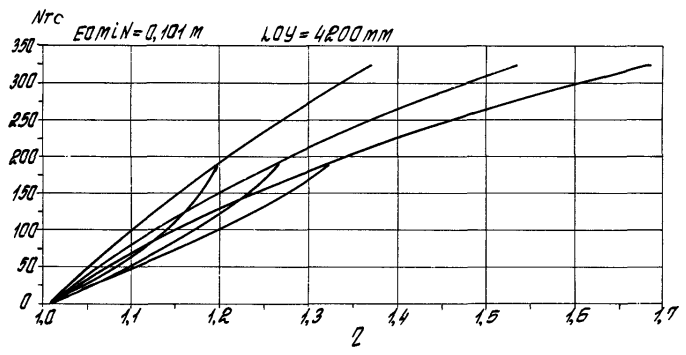
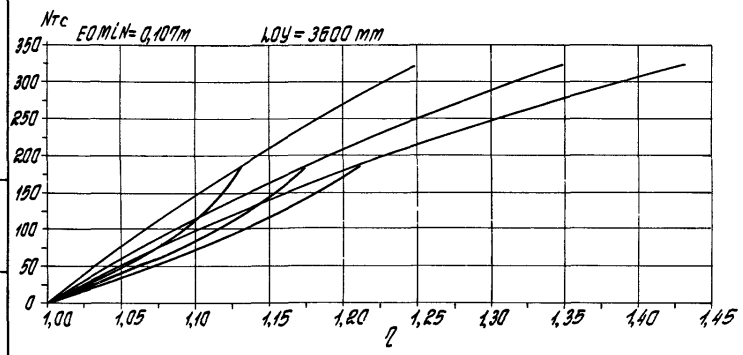
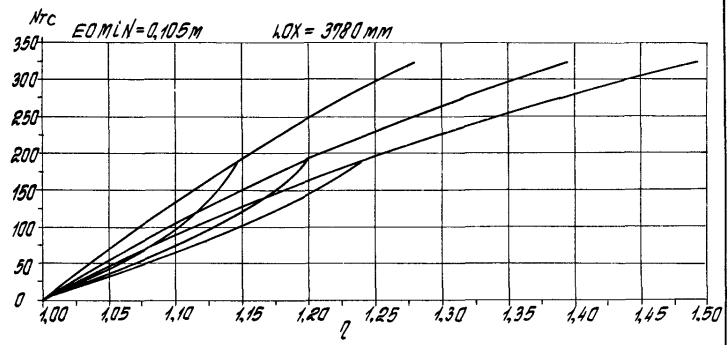
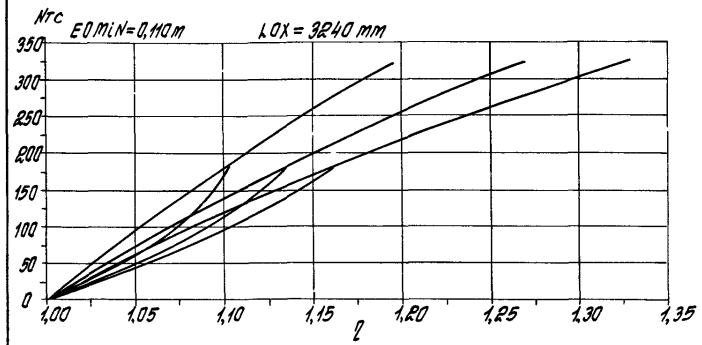

1.020. 1-4 0-9 002 Илуст
122

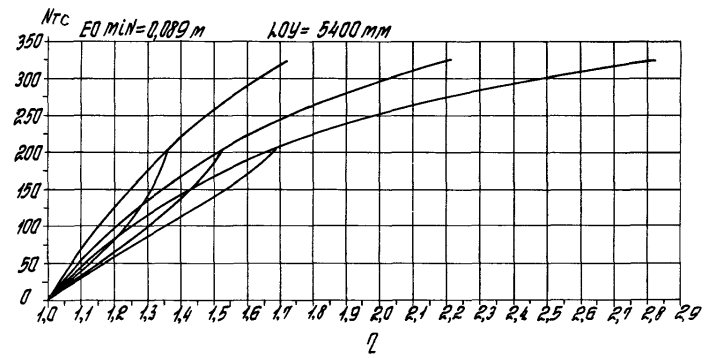
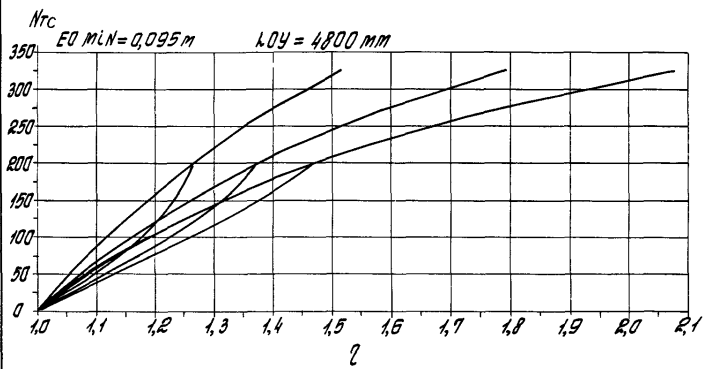
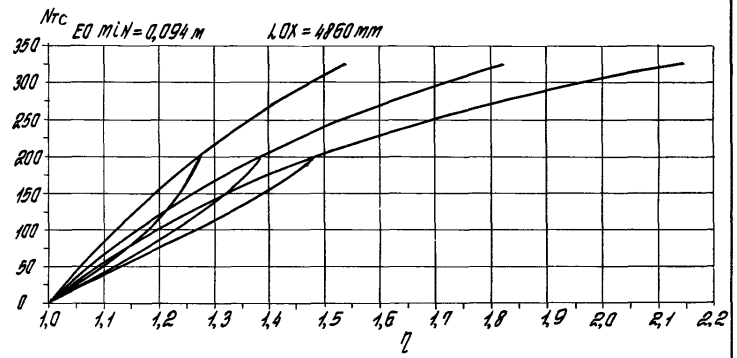
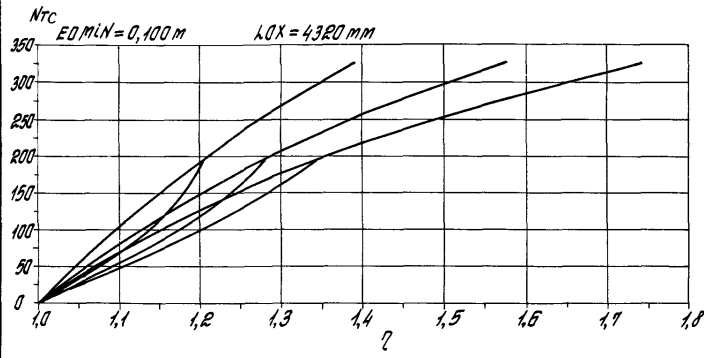

Указана нагрузка в расчете на метр погонный

1.020. 1-4	0-9 102	л/см 123
------------	---------	-------------



Таблица 1. Расчеты по формуле (1.1)

1.020. 1-4 0-9 002 N_{rcm}
 124

1:100 10 мм/мг
Исполнитель: [Signature]
Дата: [Signature]

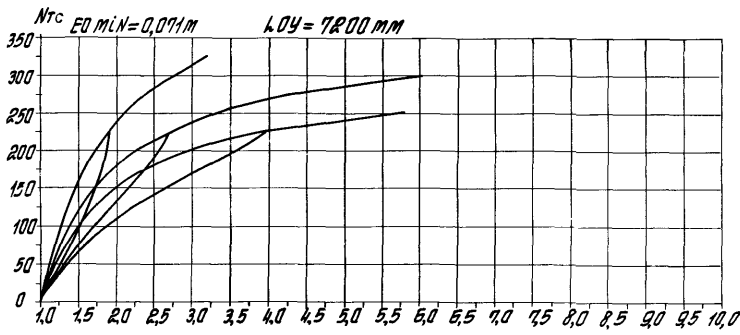
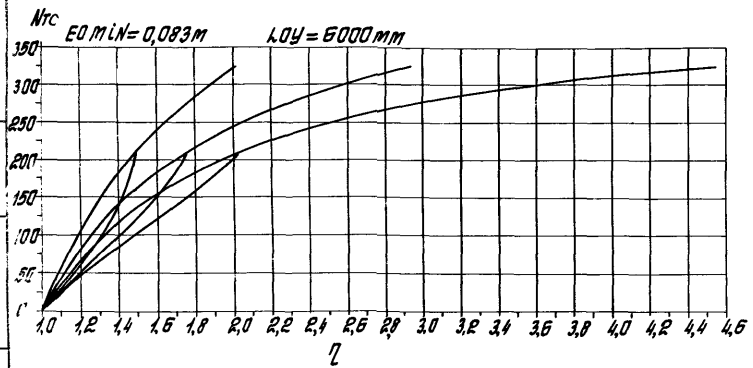
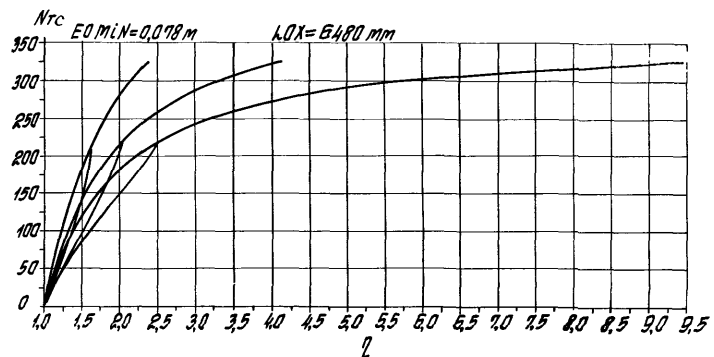
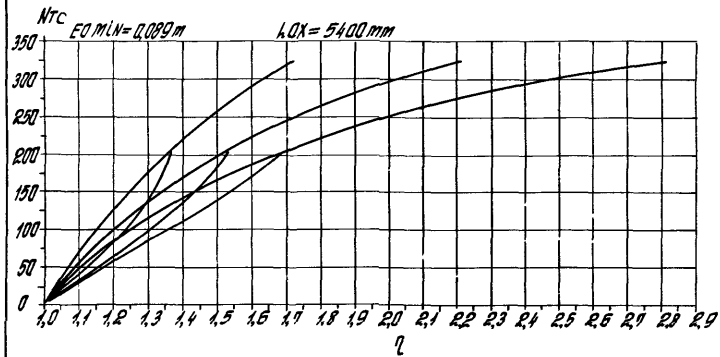
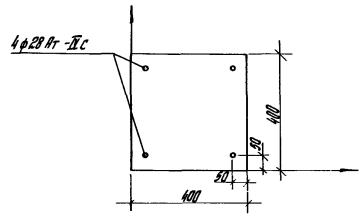
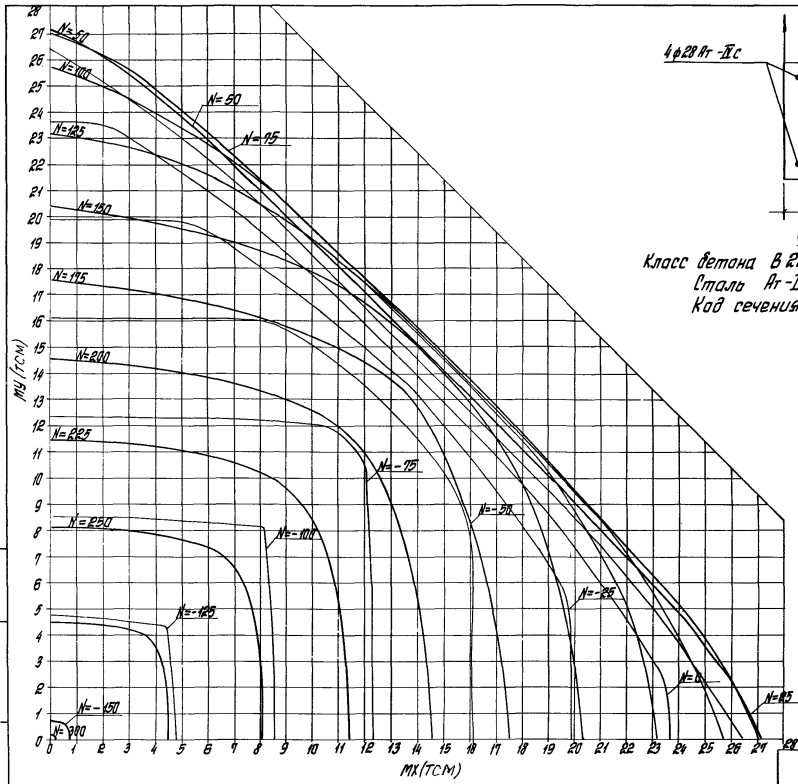

$(R_b = 11,7)$
 Класс бетона В 22,5 МПа при учете $\gamma_{b2} = 0,90$
 Сталь Аг-ІІс
 Код сечения - 116Б

1.020.1-4 0-9 002 ИЛМ
 12.5

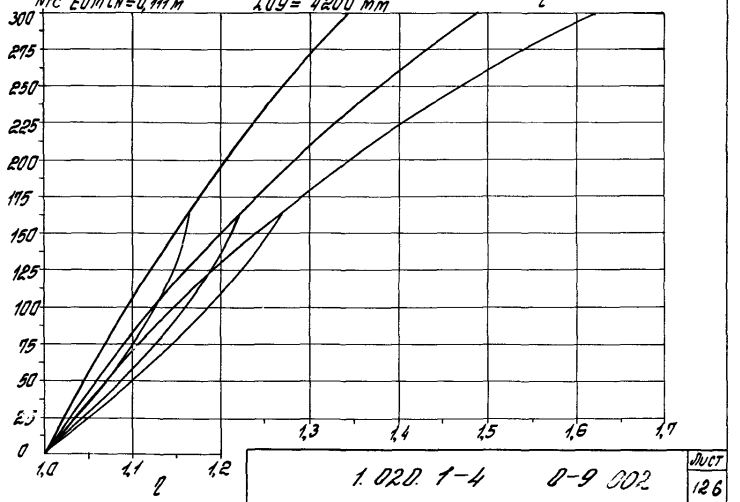
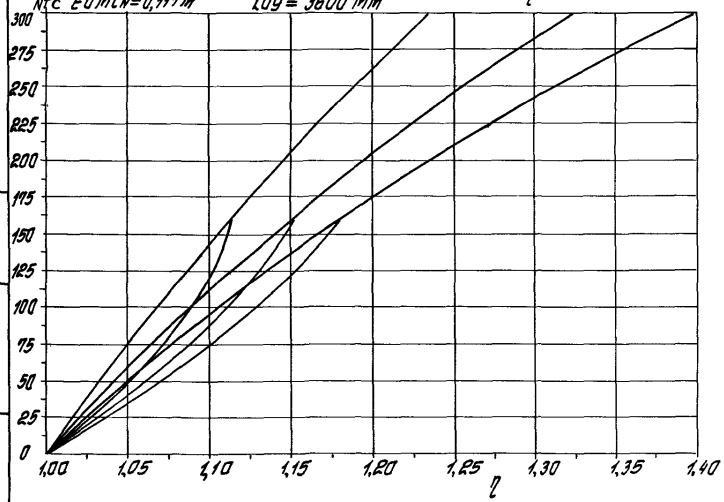
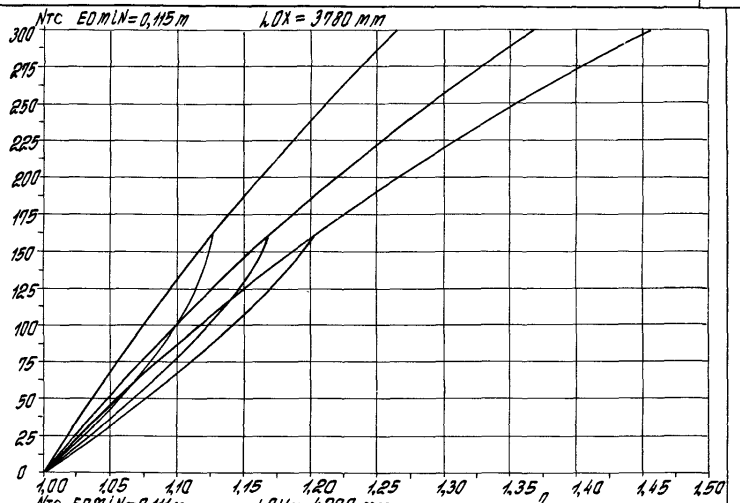
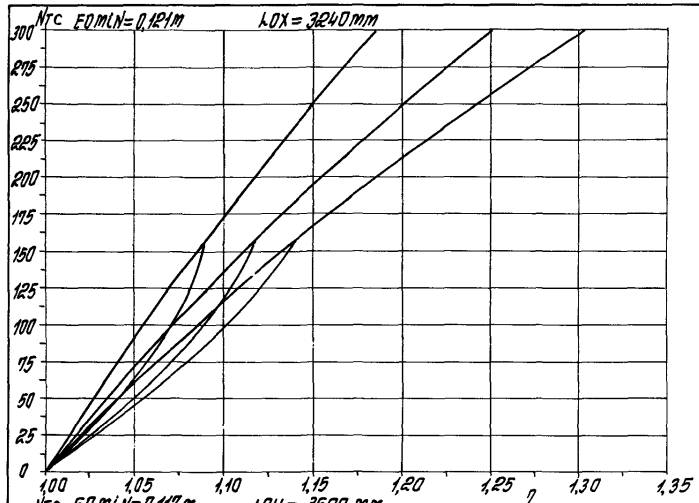

LAW OF THE ...

1.020. 1-4 0-9 002

WUCT
126

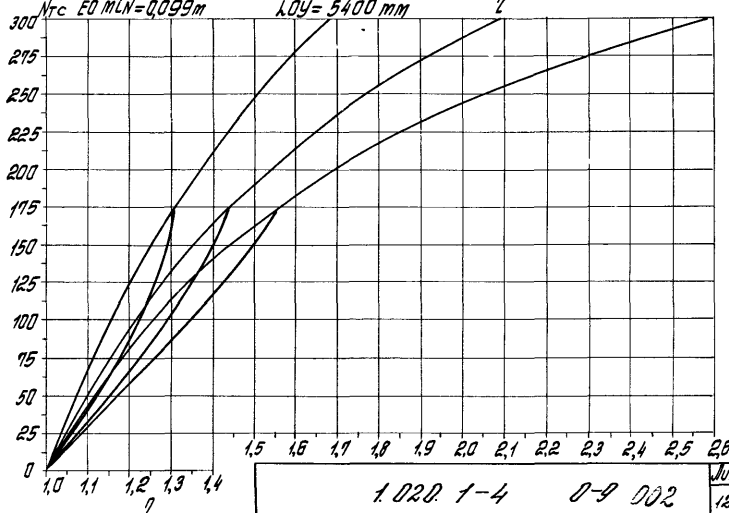
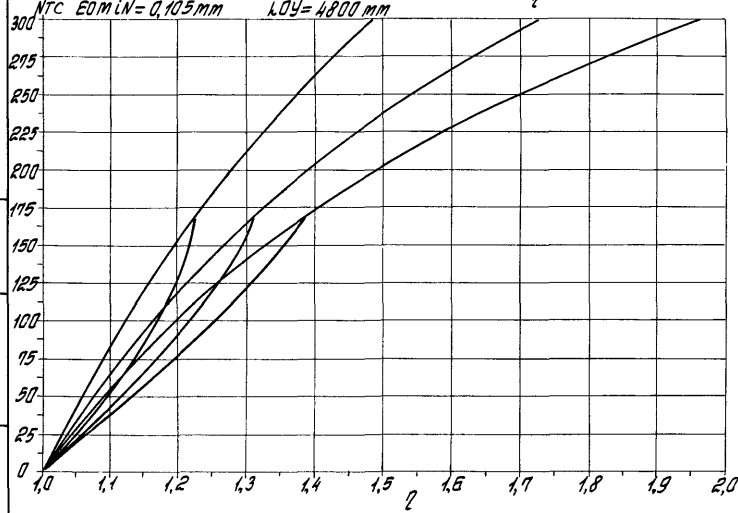
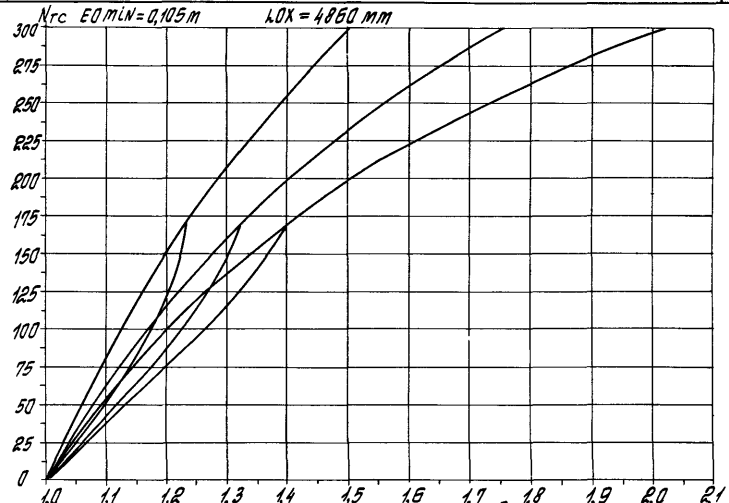
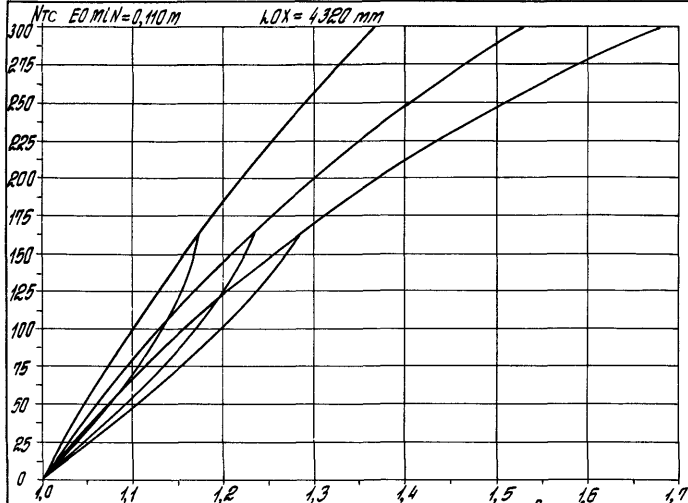

Nrc EO min = 0,110 m LOX = 4320 mm

1.020.1-4	0-9 002	Юсн 127
-----------	---------	------------

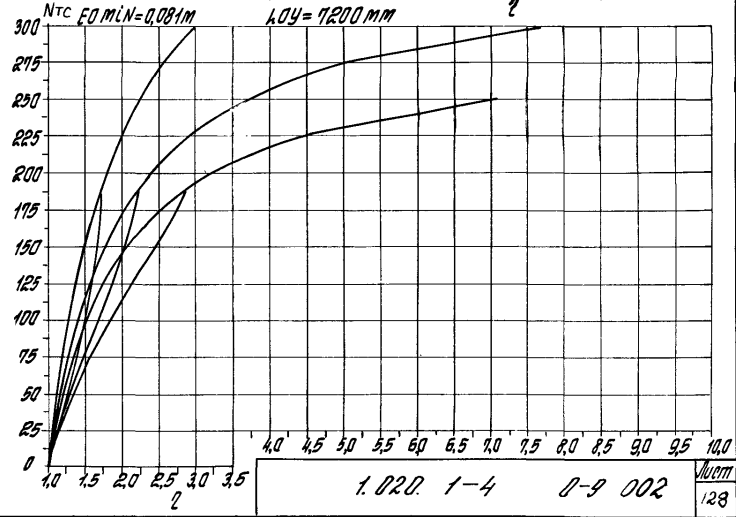
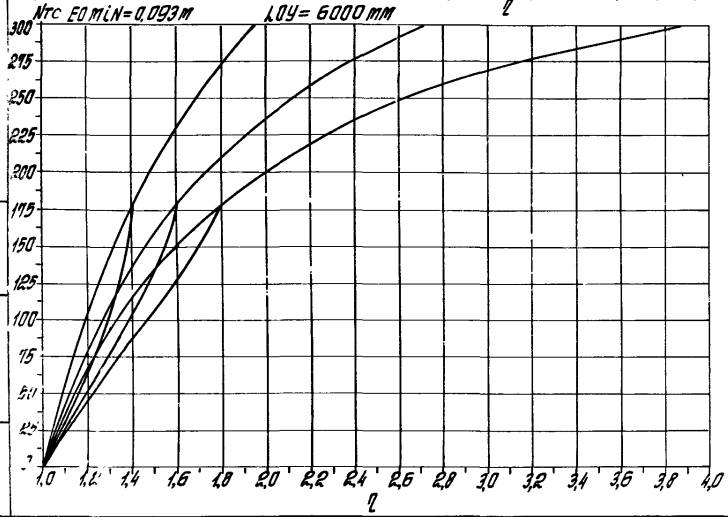
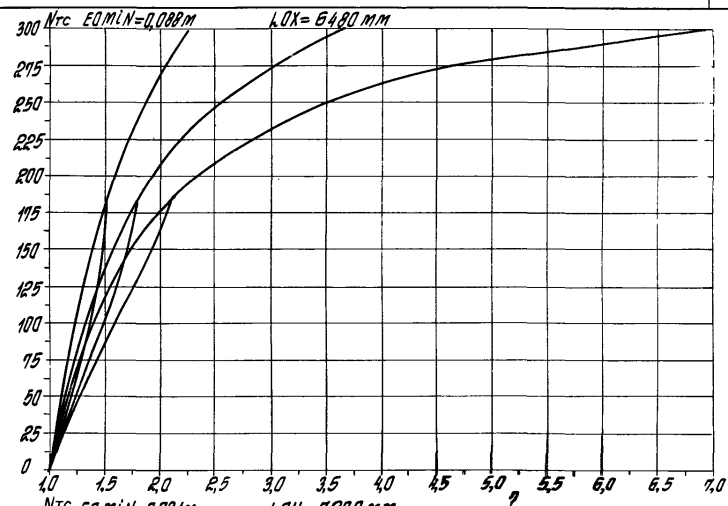
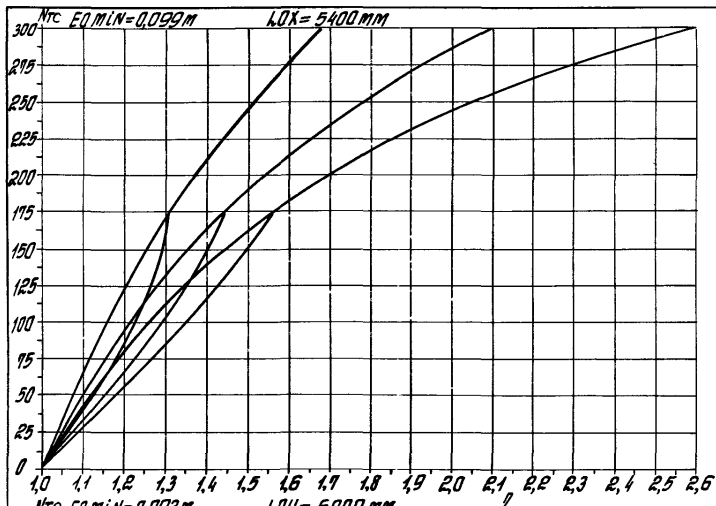

Шкала по ГОСТ 10000-80 и ГОСТ 10000-80

1.020. 1-4 0-9 002

Метр
128

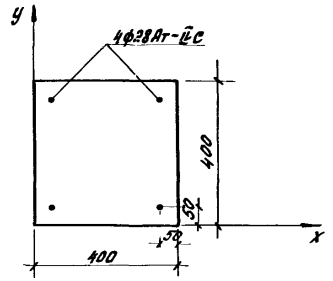
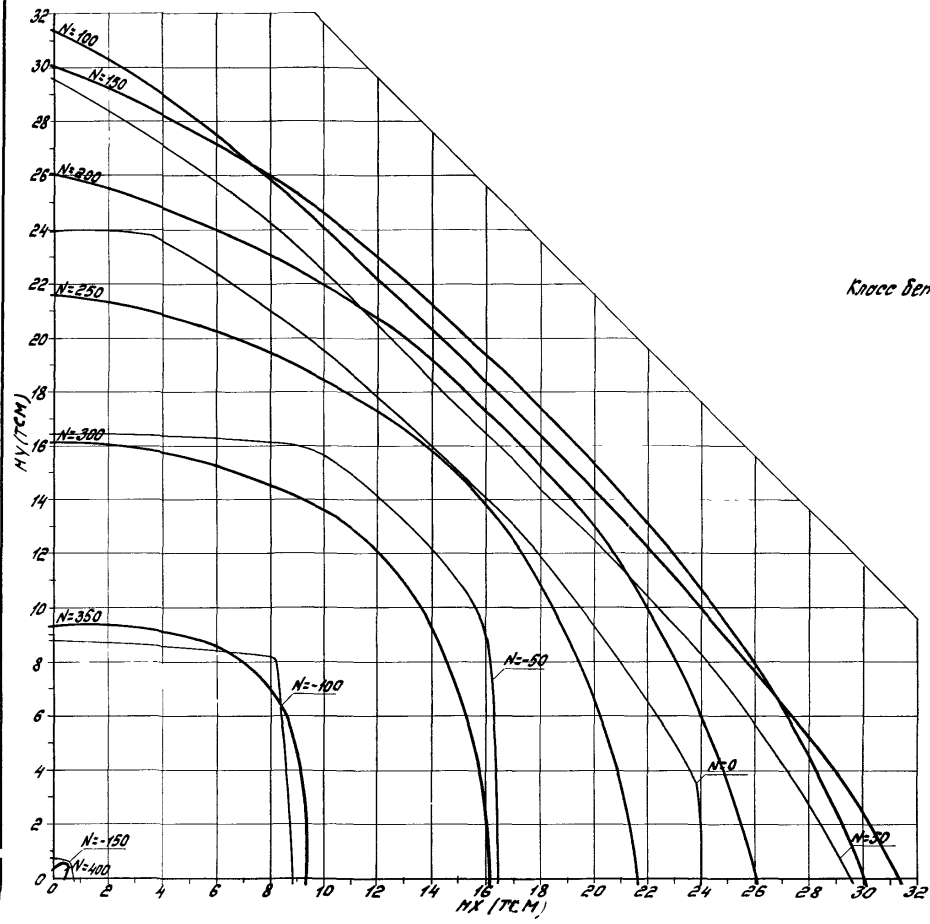

Класс бетона В30.0 ($R_c = 18.7 \text{ МПа}$ при учёте $\gamma_{б2} = 1.10$)
 Сталь Аг-Бс
 Код сечения - 117а

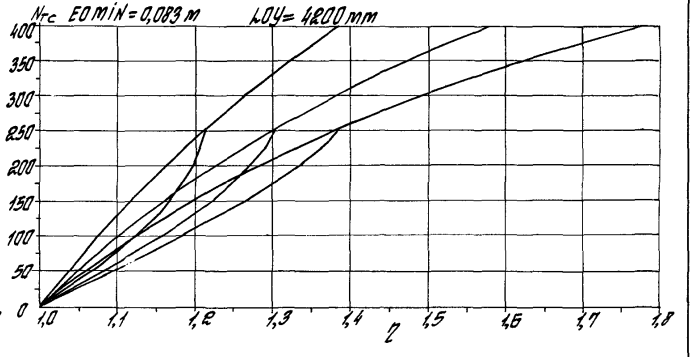
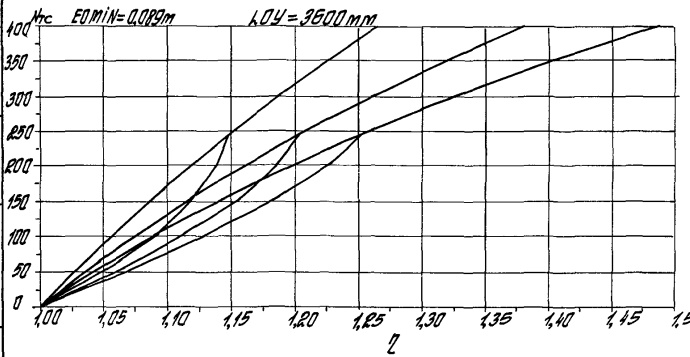
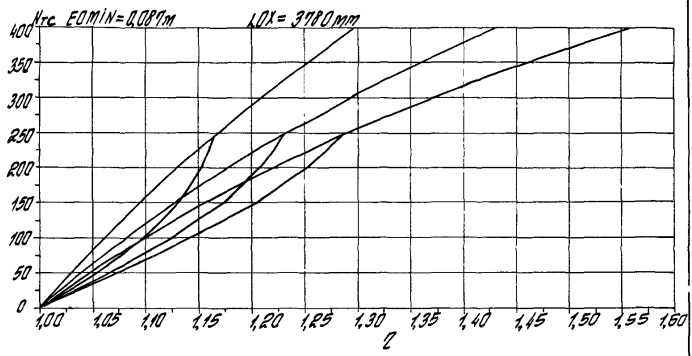
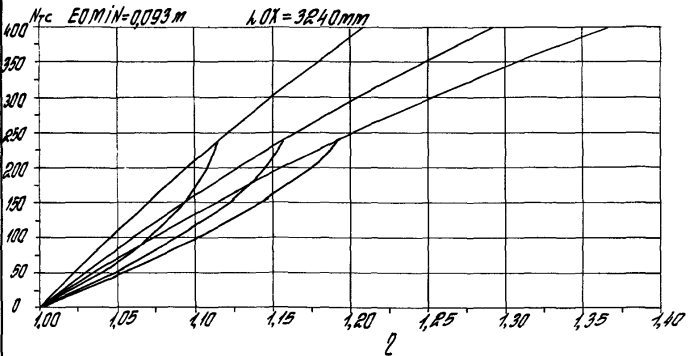

Mrc E_{0MIN} = 0,093 m
 Mrc E_{0MIN} = 0,087 m
 Mrc E_{0MIN} = 0,089 m
 Mrc E_{0MIN} = 0,083 m

1.020.1-4 0-9 002 Ауст 190

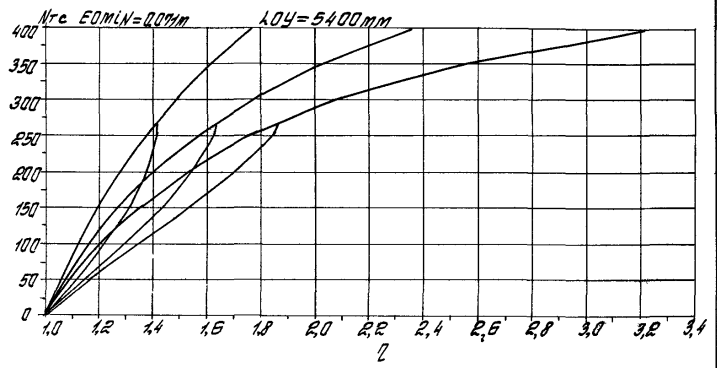
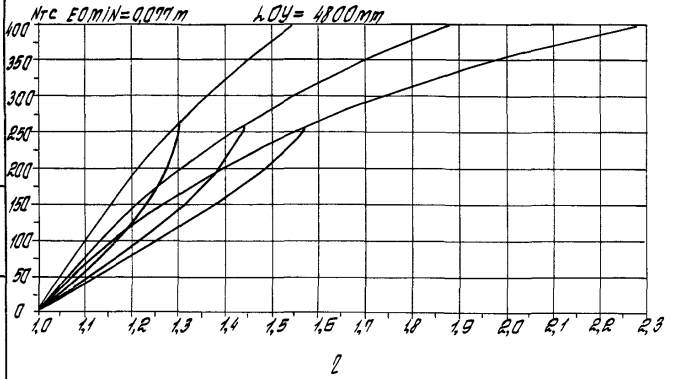
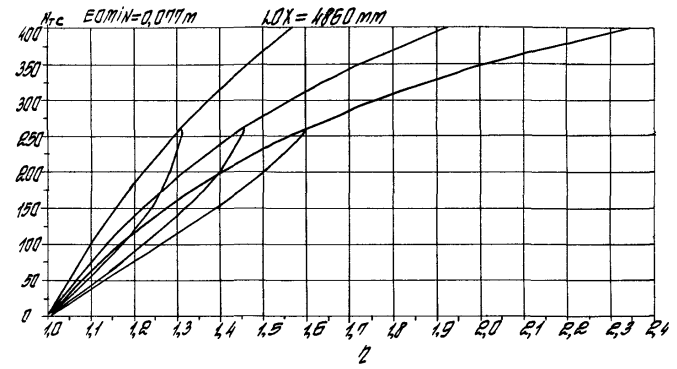
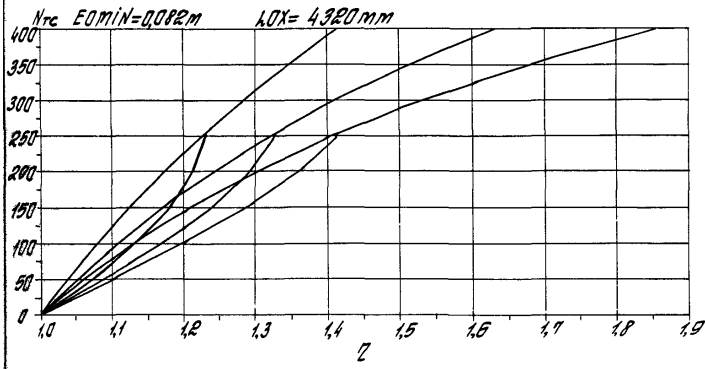

Универсальный график для определения коэффициента N_{rc}

1.020.1-4 0-9 002	Лист 131
-------------------	-------------

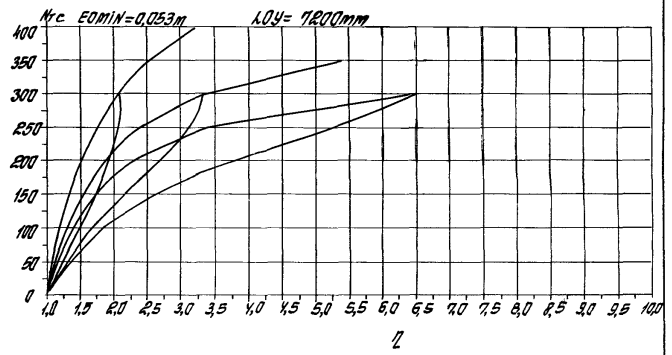
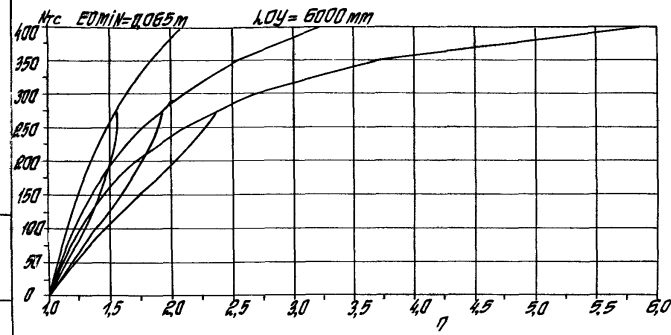
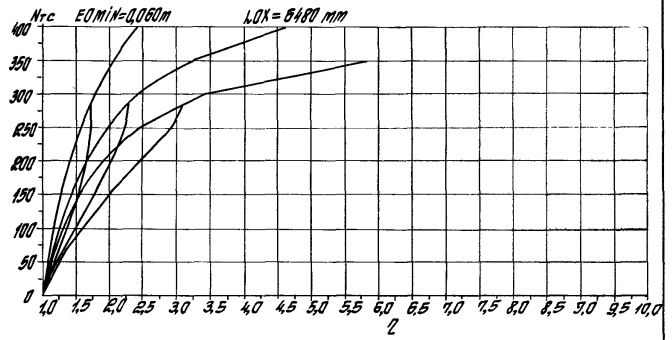
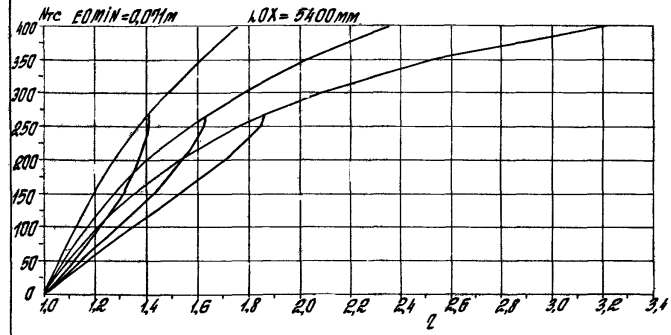

ШИР. КОМП. УСТАВ. У РАД. МАШИНАМА

1.020.1-4 0-9 002

198

4φ20Aт-IVС

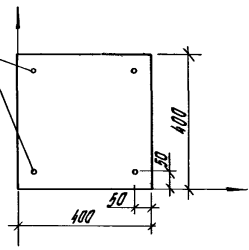

Класс бетона В 30,0 (R_R = 15,9 МПа при учете γ_{R2} = 0,90)
 Сталь Ат-IVС
 Код сечения - 117Б

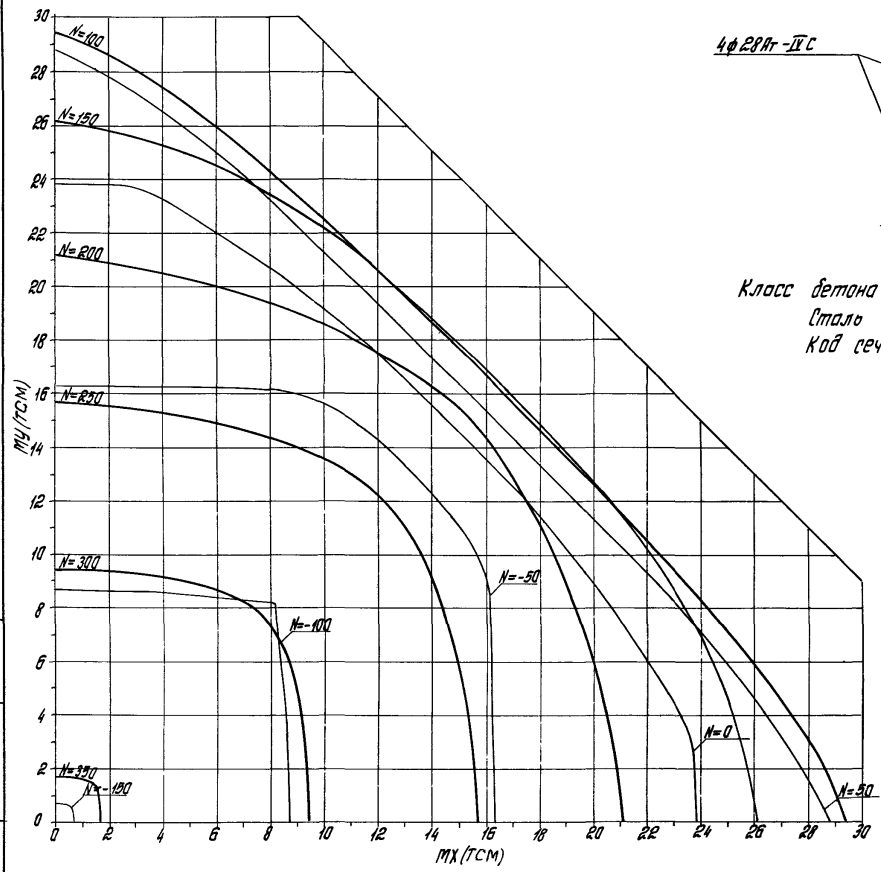

ММДП-117Б, ВООУИИЛС, ДОСТУП В СЕТИ ИЛИ В ЛИБ

1.020.1-4	0-9 002	Лист 138
-----------	---------	-------------

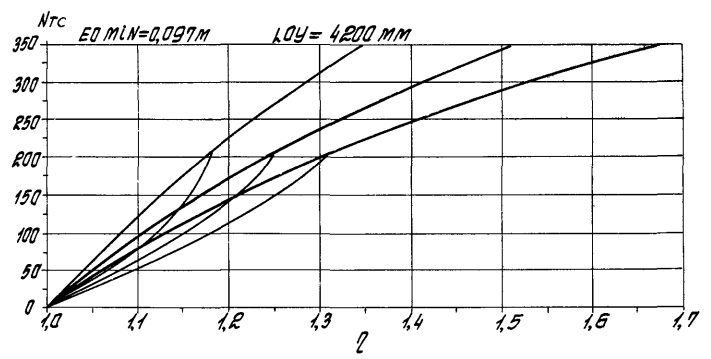
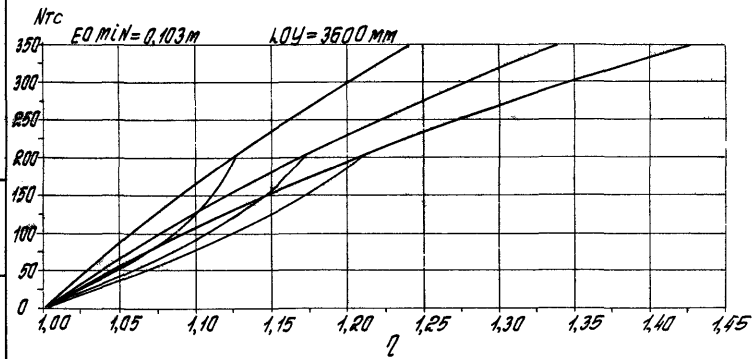
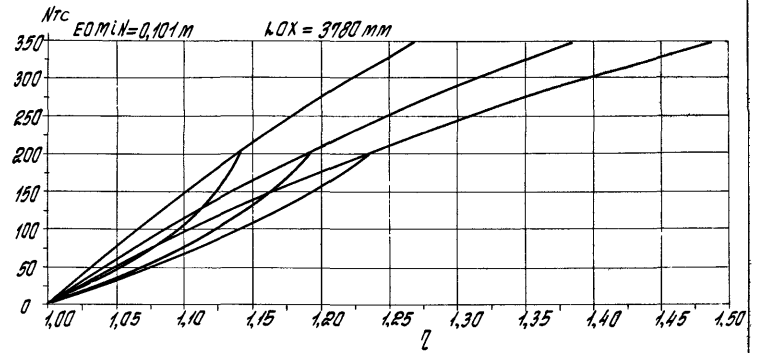
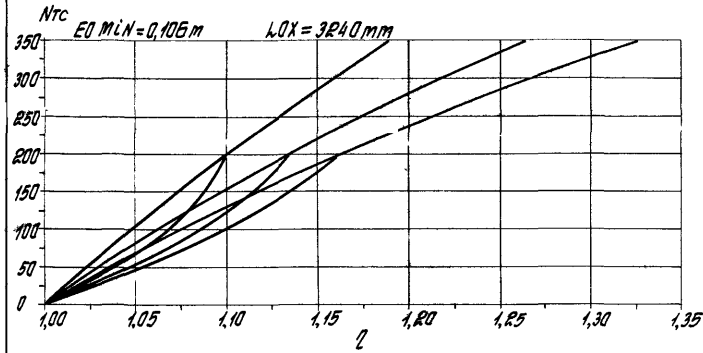

1.020.1-4 D-9 002
 1944

1.020.1-4 D-9 002
 1944

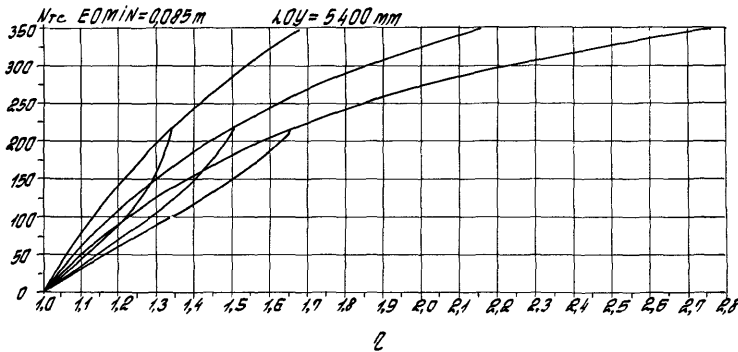
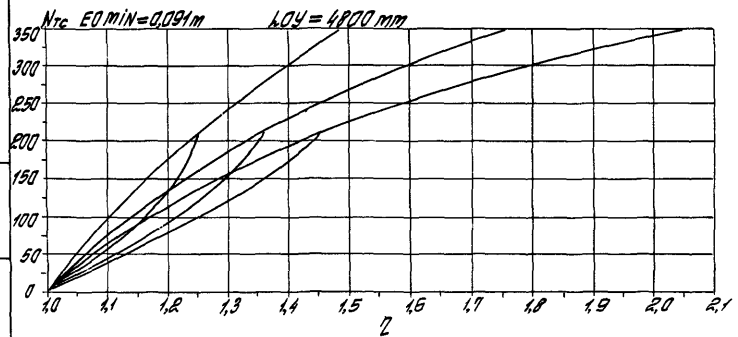
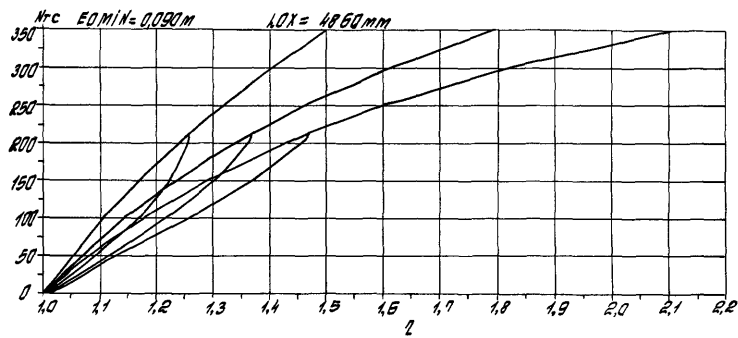
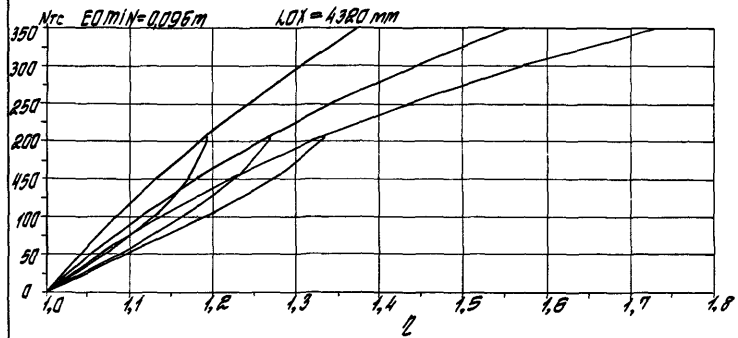

Věk...-di... v...-...-...-...-...

1.020.1-4 0-9 002 Nrcm
135

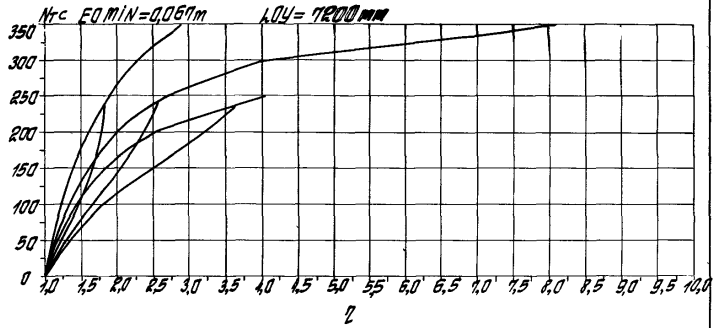
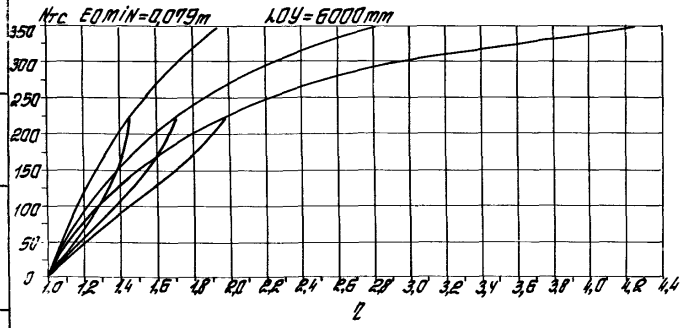
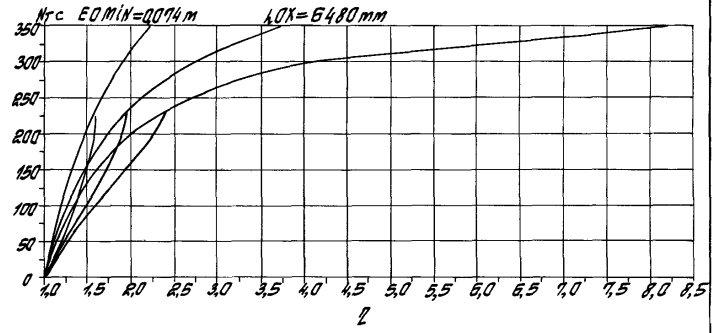
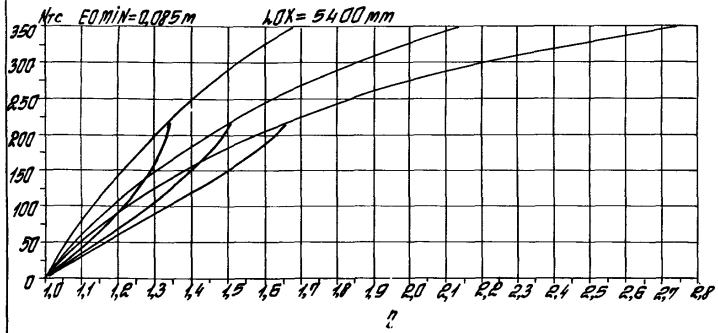

Лист № 2024. Издание и дата: 13.08.01

1.020.1-4 0-9 002	Лист 138
-------------------	-------------

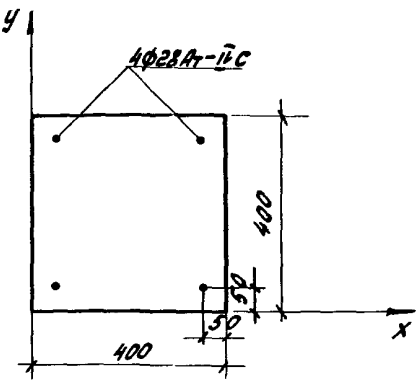
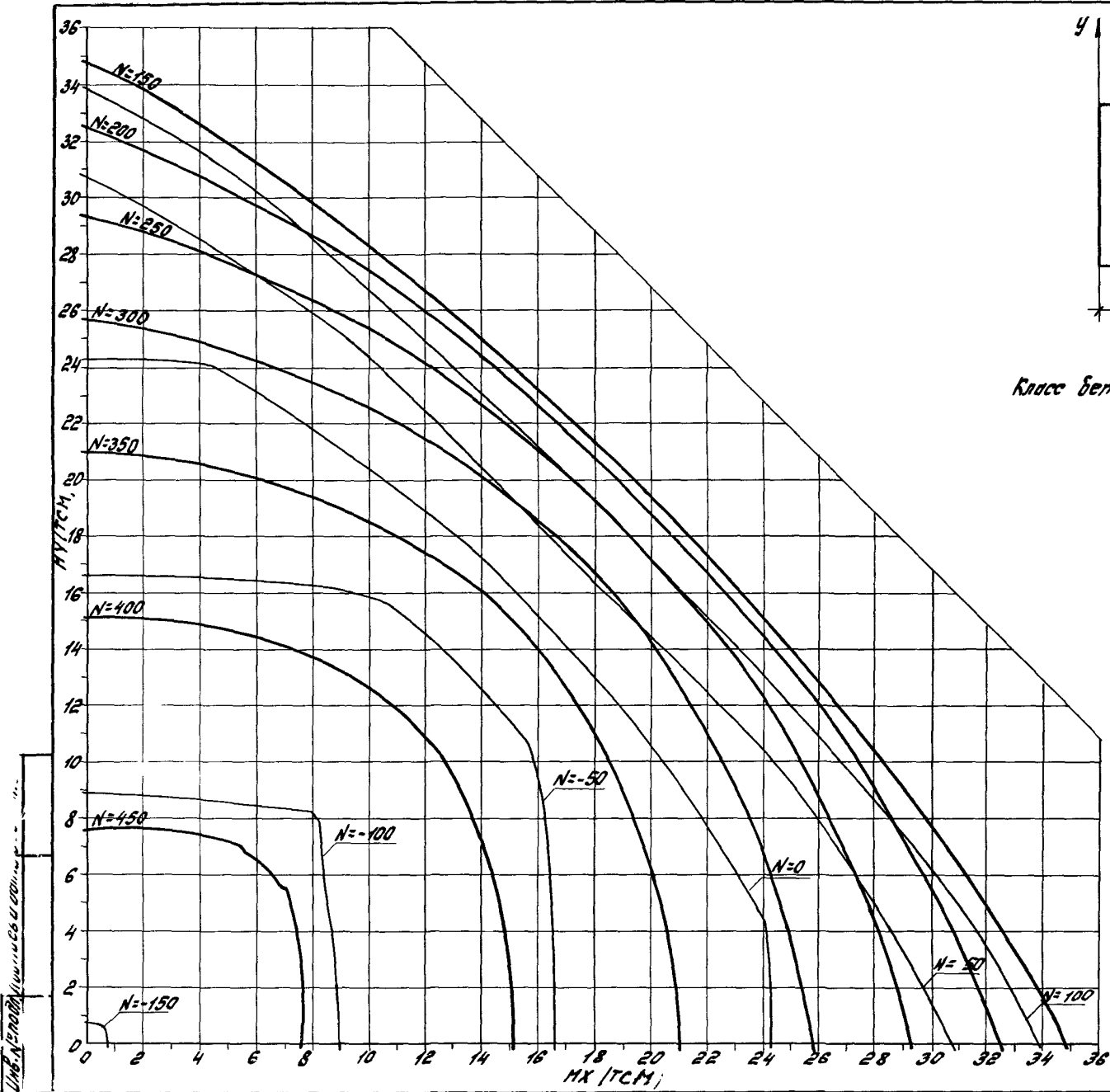

Класс бетона В40.0 ($R_b = 24.2 \text{ МПа}$ при учёте $\gamma_{R2} = 1.10$)
 Сталь Ат-II С
 Код сечения - 118 а

1.020. 1-4 0-9 002

Лист
137

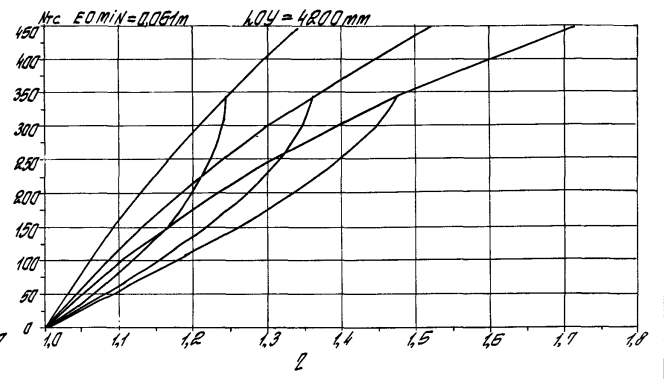
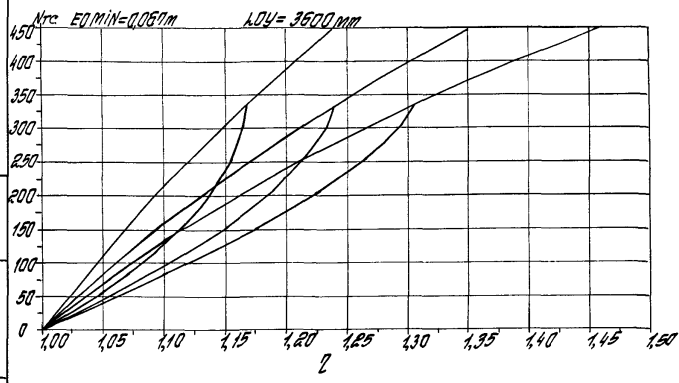
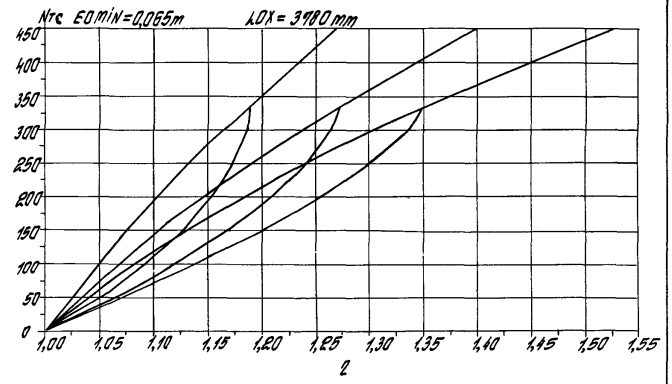
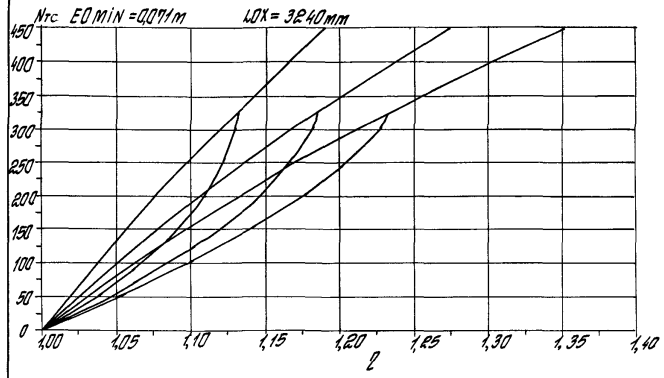

Лист № 002. Подписан в Санкт-Петербурге, 1938

1.020.1-4 0-9 002 Лист
138

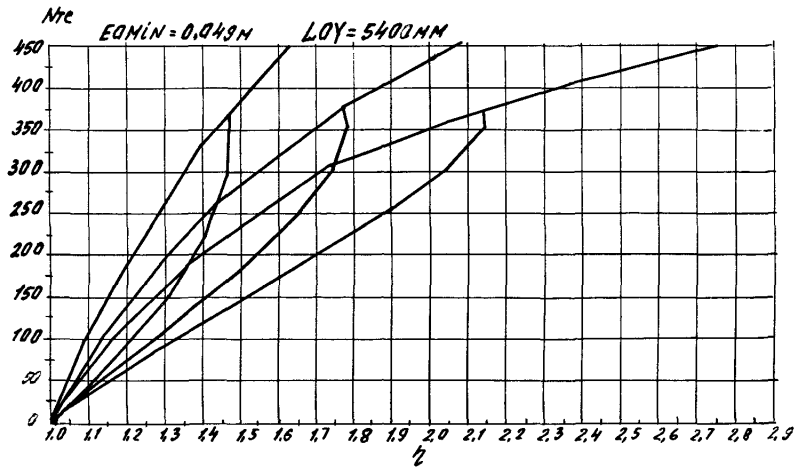
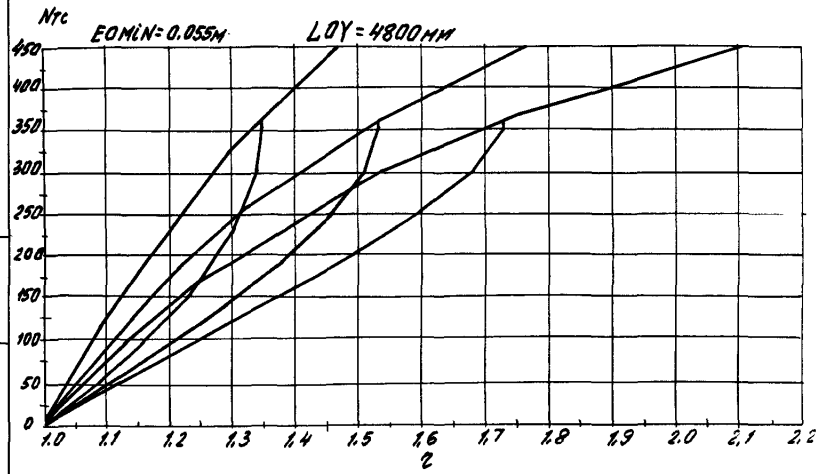
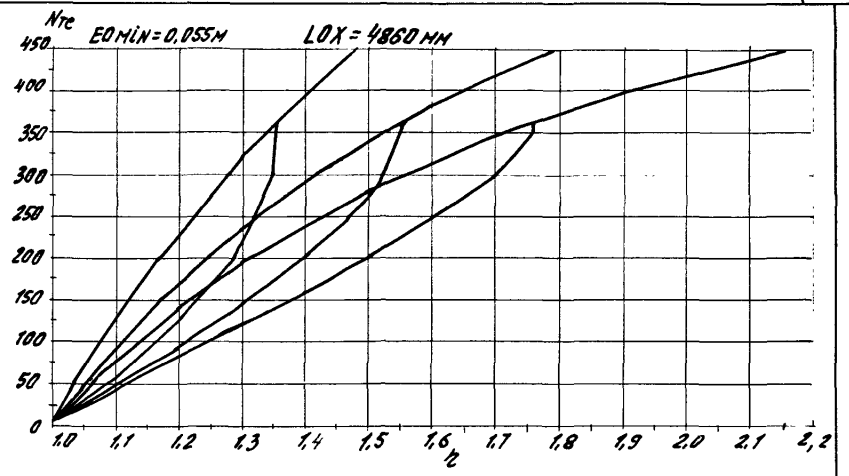
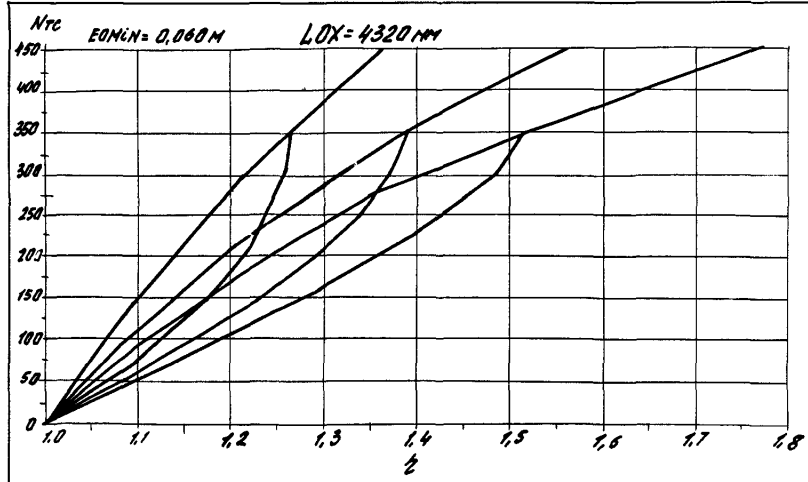

УМБ АН ИОА Д "ИСС И ОРО" ВРОУ УИВ АН

1.020.1-4 0-9 002 139

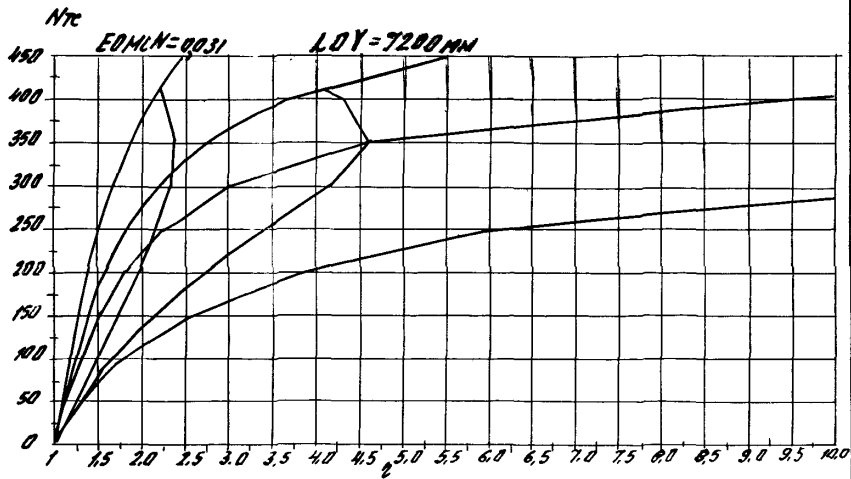
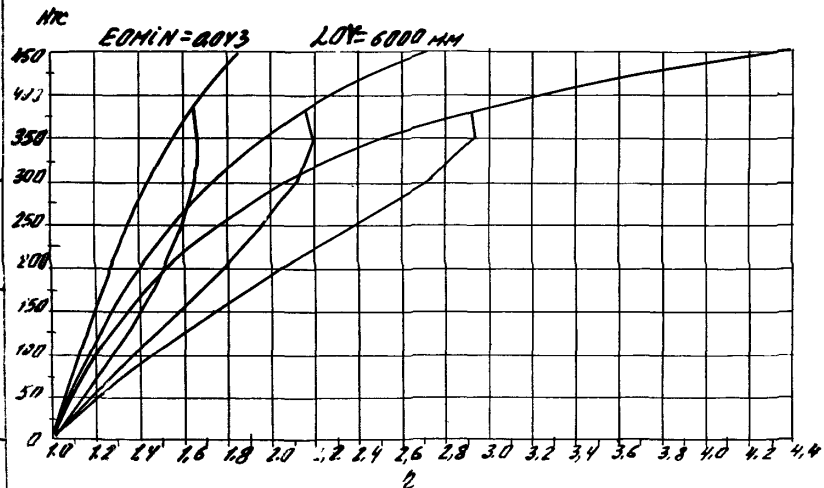
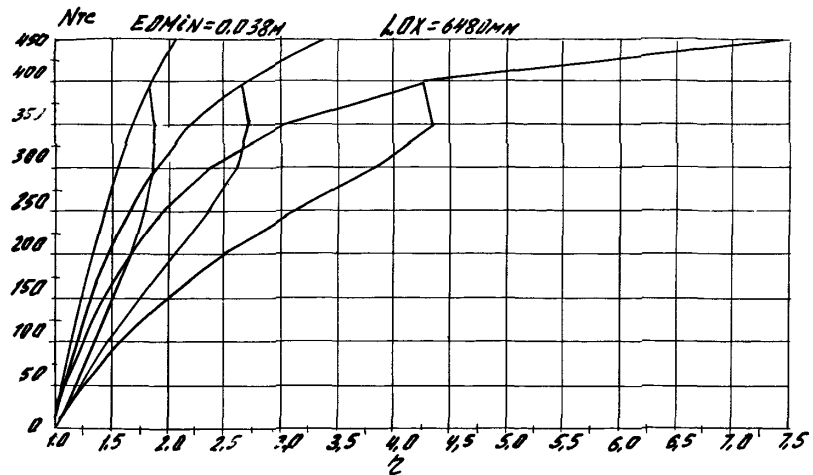
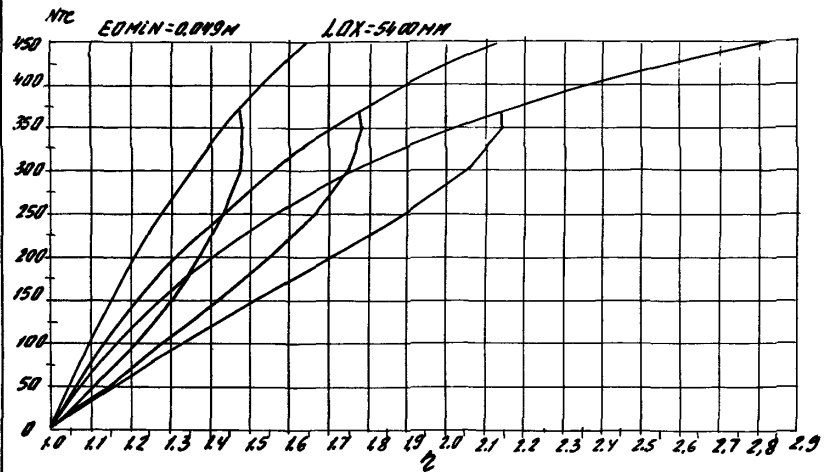

1408.145 мод.11. Подписано и датировано в соответствии с требованиями ГОСТ 1020.1-4

1.020.1-4 0-9 002

ИЗДАЕТ
140

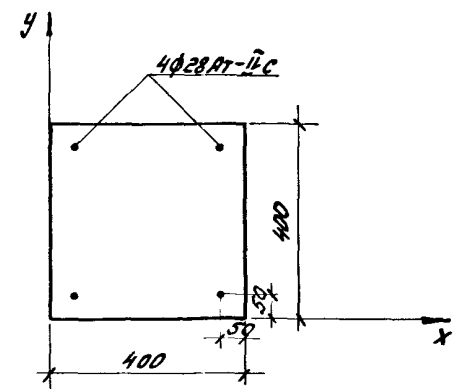
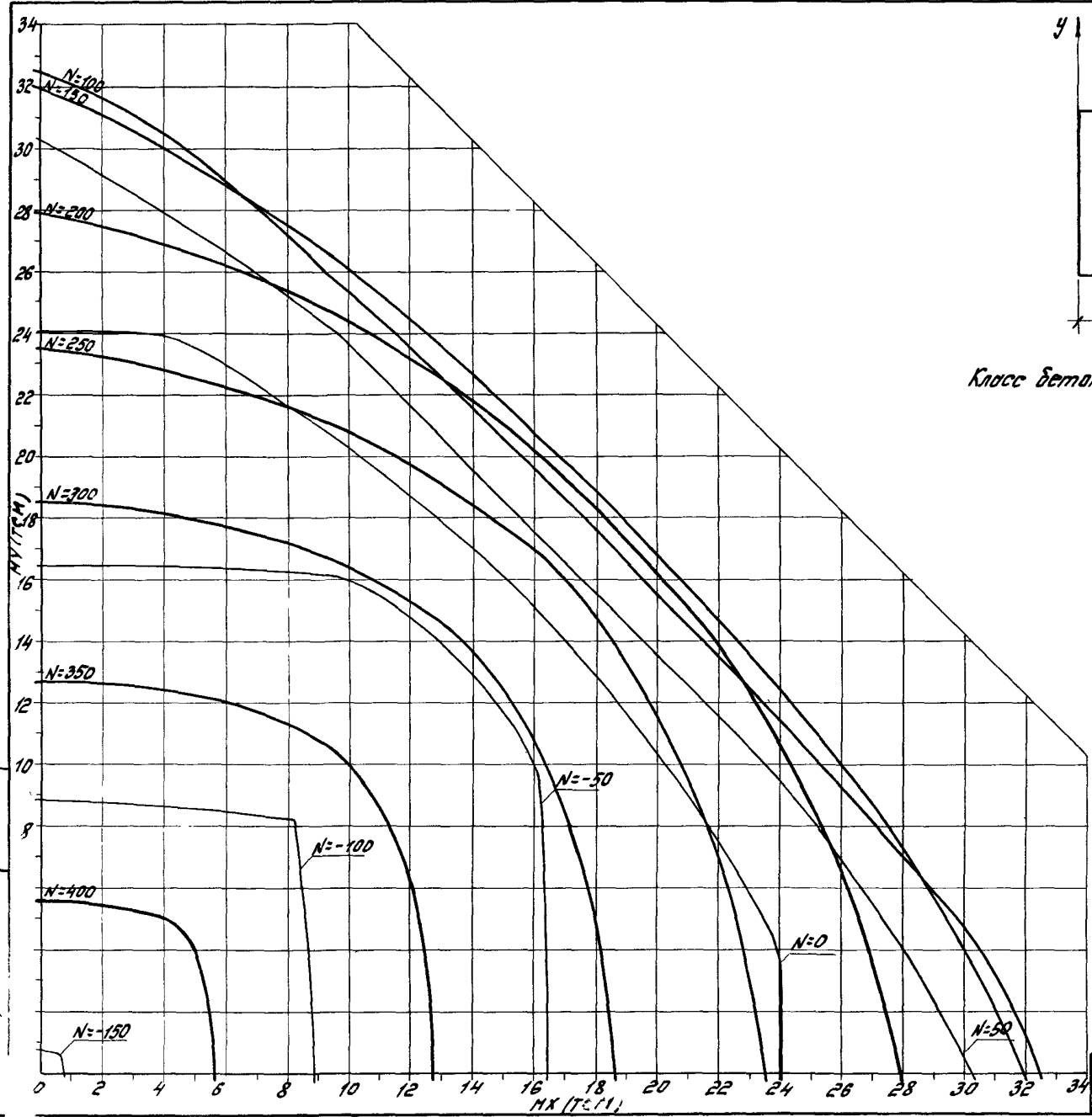

Класс бетона В40.0 ($R_b = 19.8 \text{ МПа}$ при учёте $\gamma_{b2} = 0.90$)
 Сталь Ат-1С
 Код сечения - 1135

1.020. 1-4 0-3 002

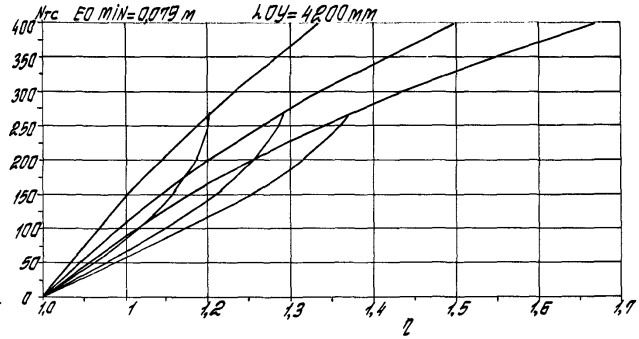
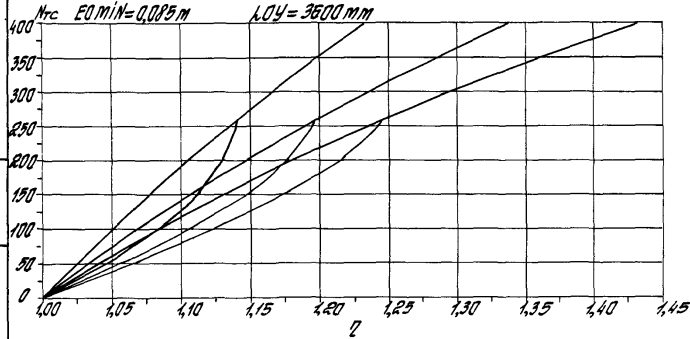
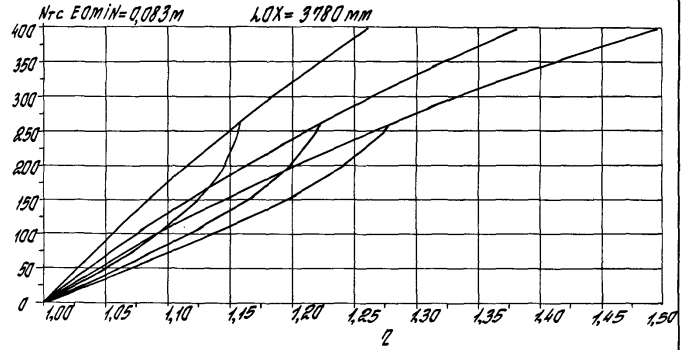
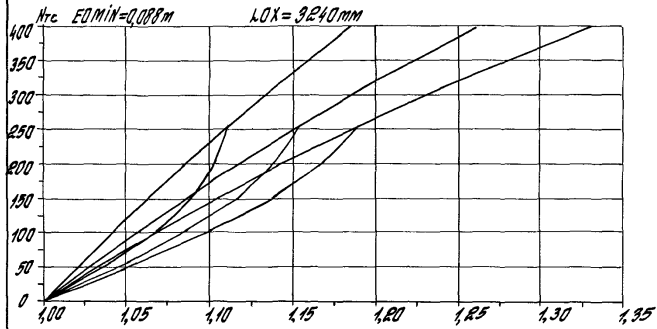

Vrsta i količina materijala

1.020.1-4 0-9 502	<i>Acem</i>
	142

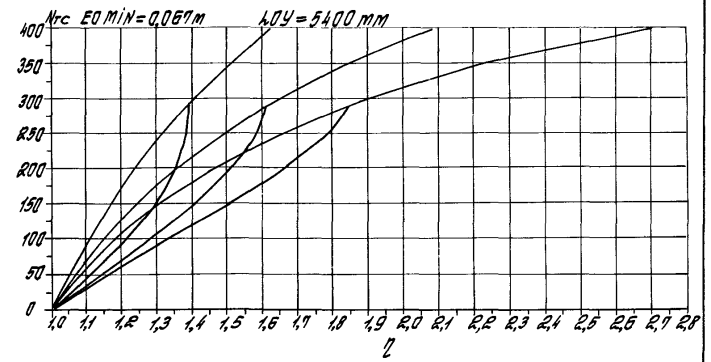
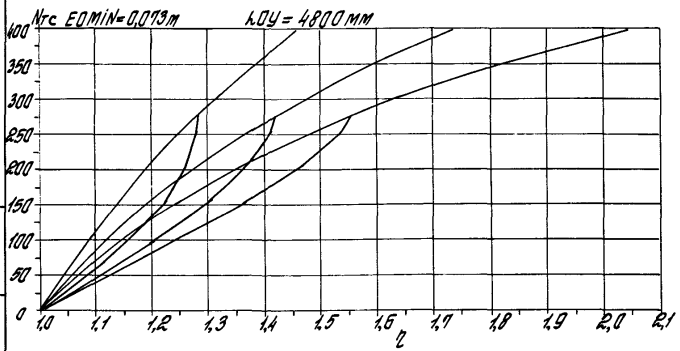
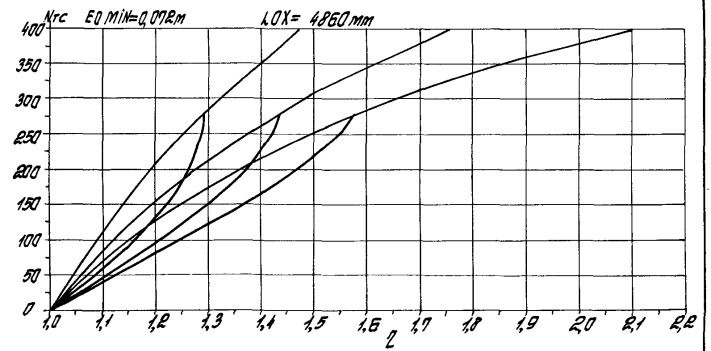
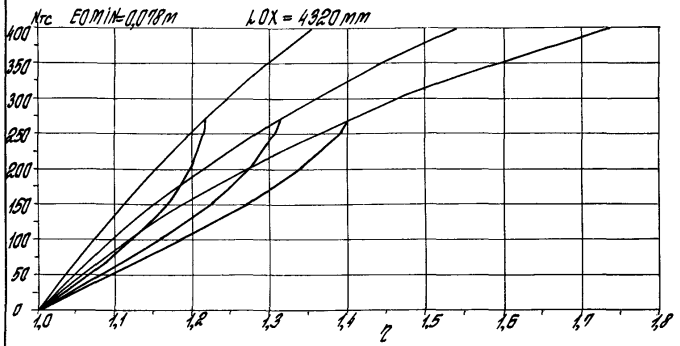

1.0201-4 0-9 002 Acem
143

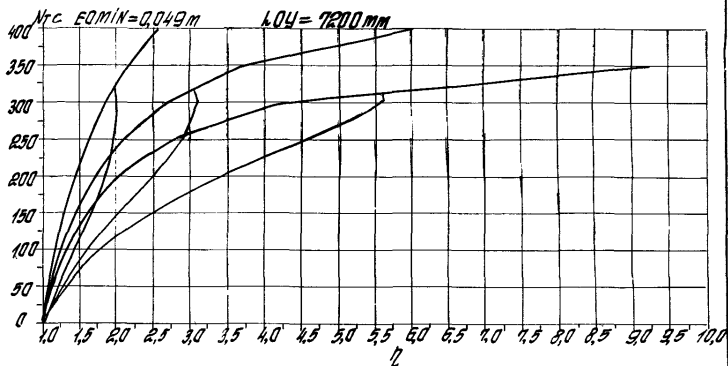
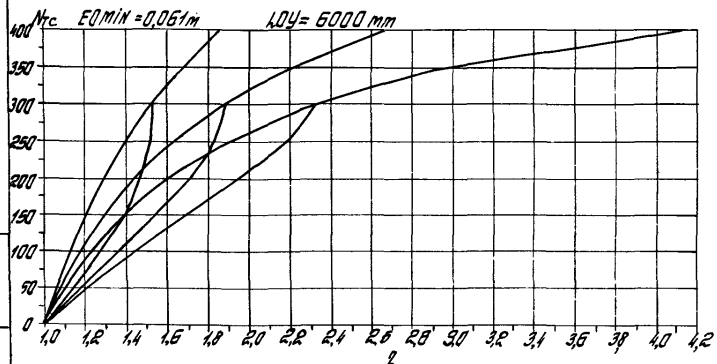
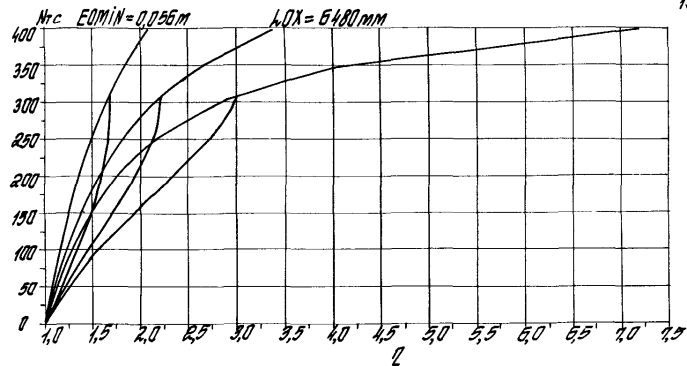
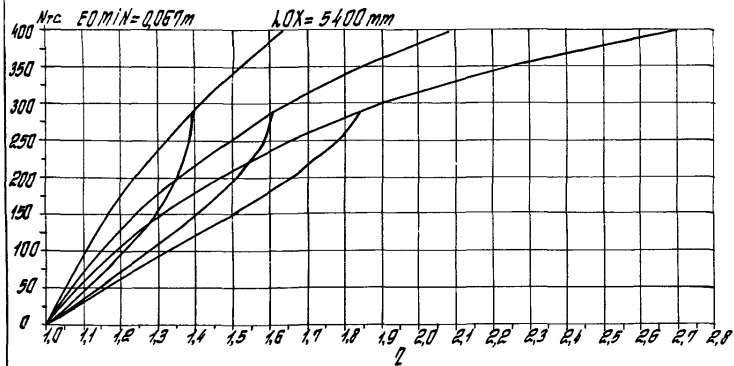

1.020.1-4 0-9 002

1.020.1-4 0-9 002	лсм 144
-------------------	------------

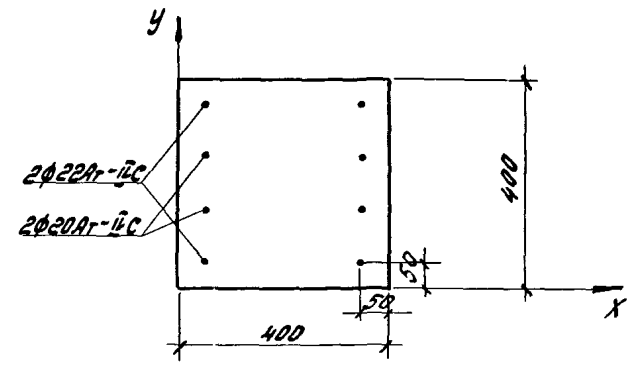
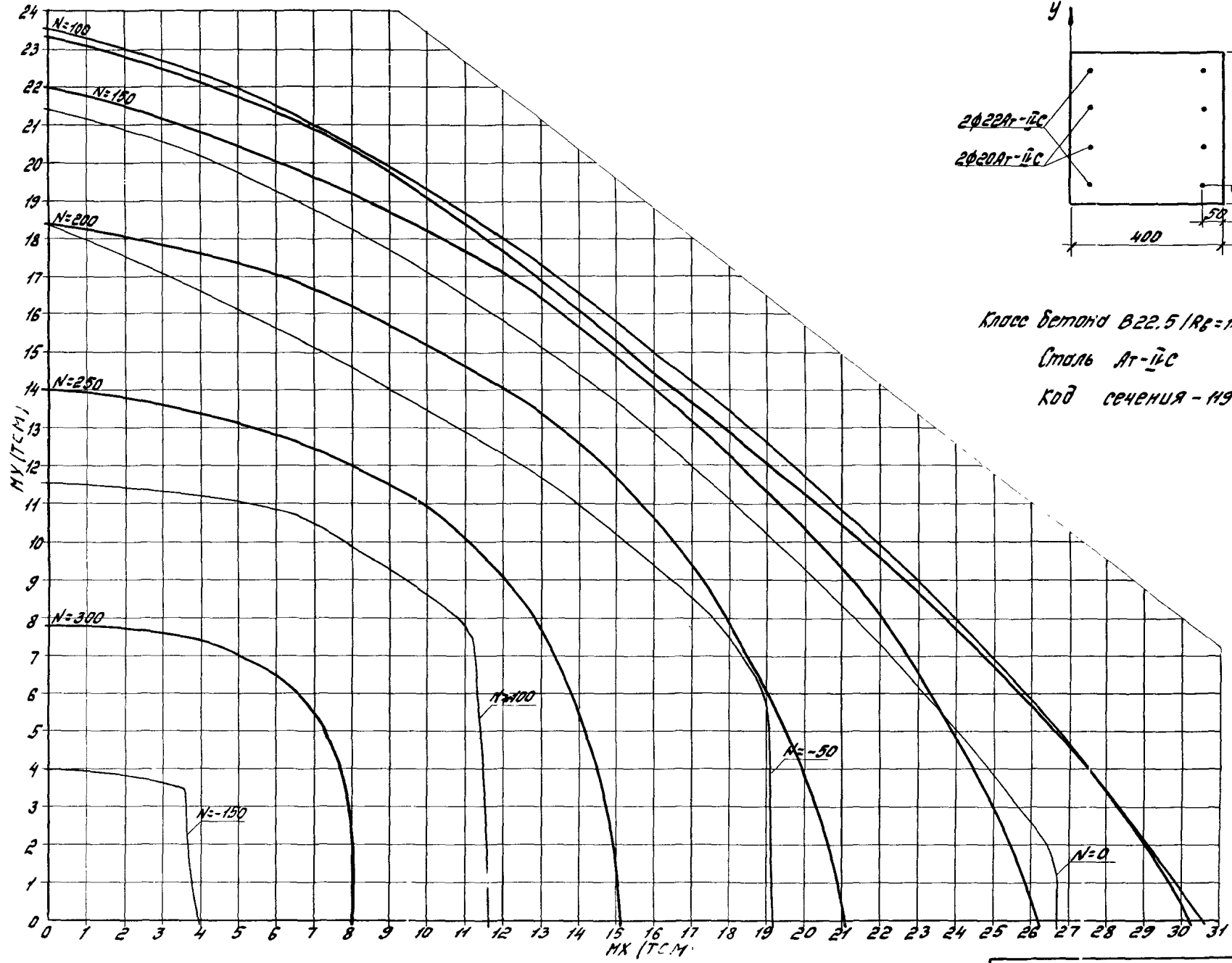

Класс бетона В22.5 / $R_b = 14.3$ МПа при учете $\gamma_{b2} = 1.10$
 Сталь Ar-1C
 Код сечения - Н94

1.025. 1-4 0-У 002 14.5

УНТА № 1000 А. ПРОВУДИТЕ У ПЛОТНОМ СЛОЮМ УНТА № 1000 А.

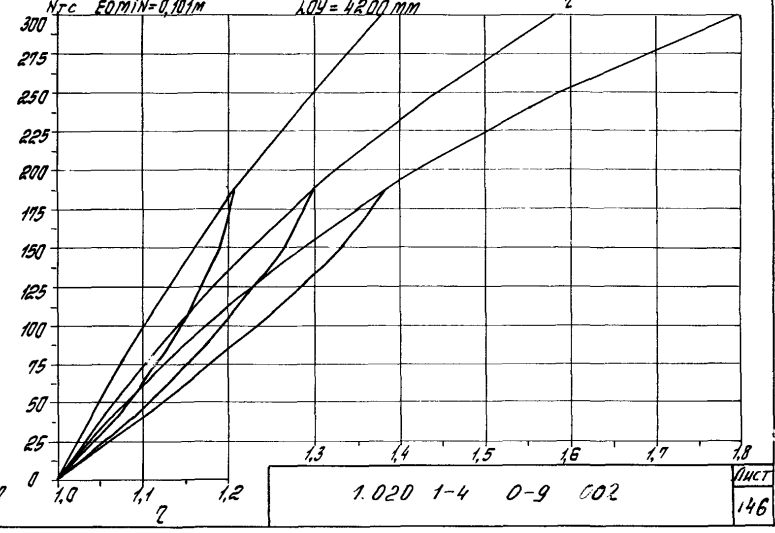
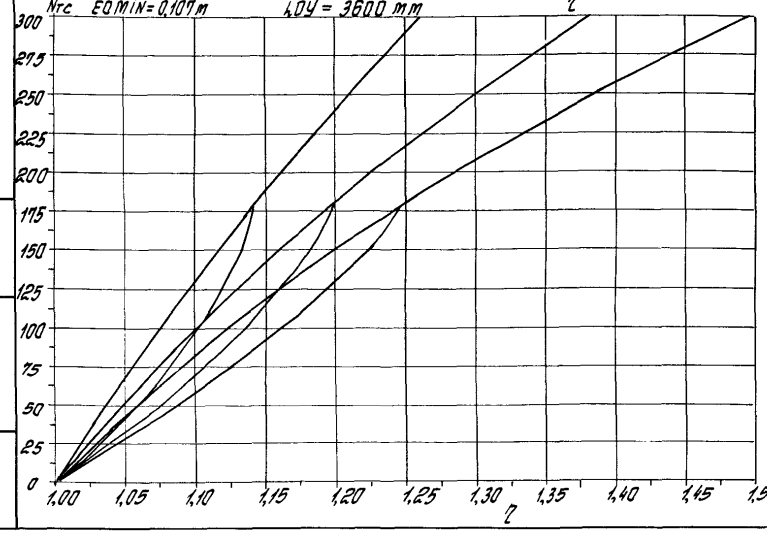
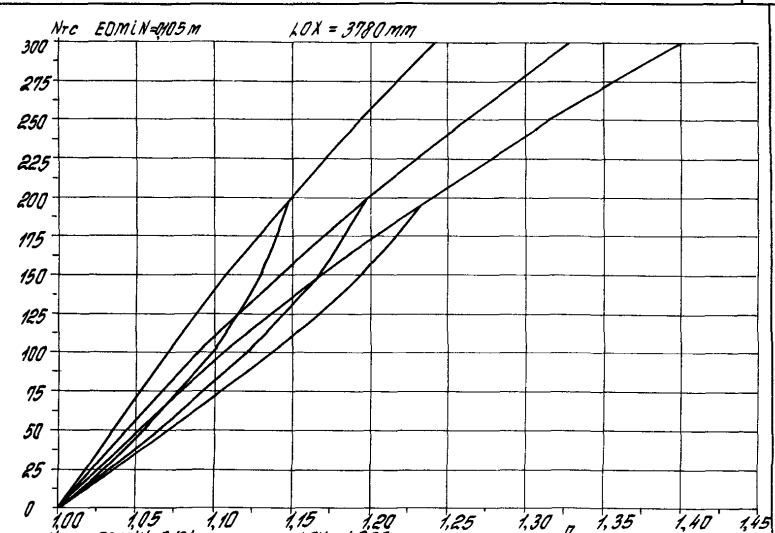
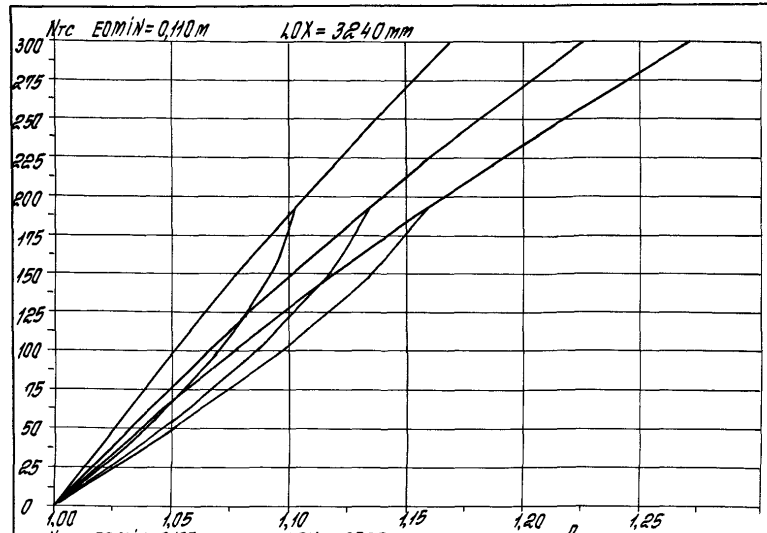

1.020 1-4 0-9 002

ДУКТ
146

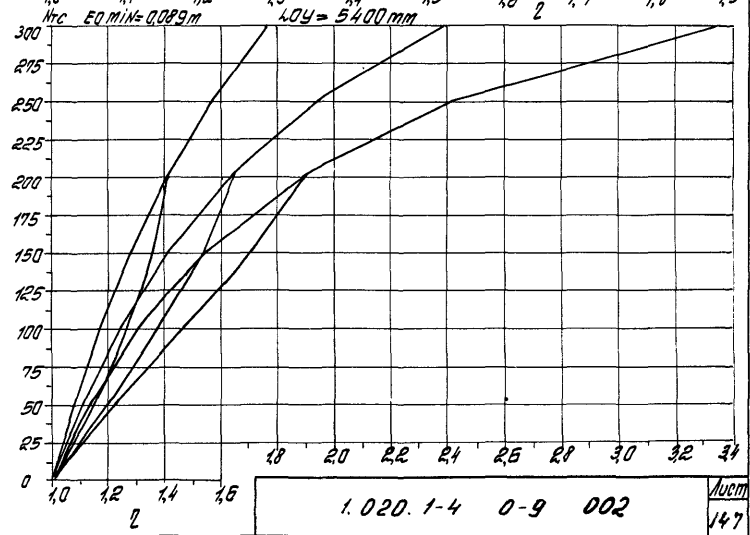
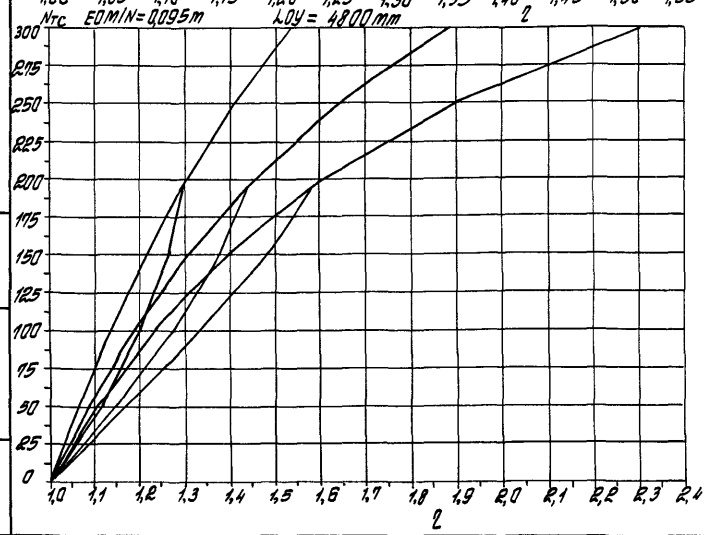
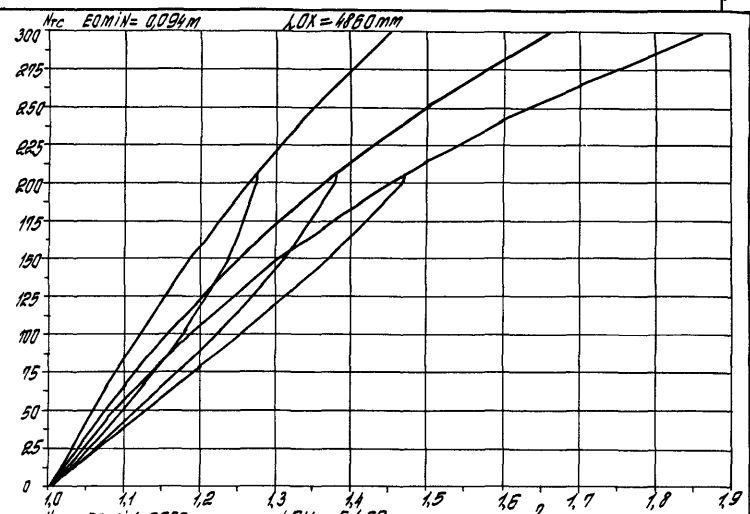
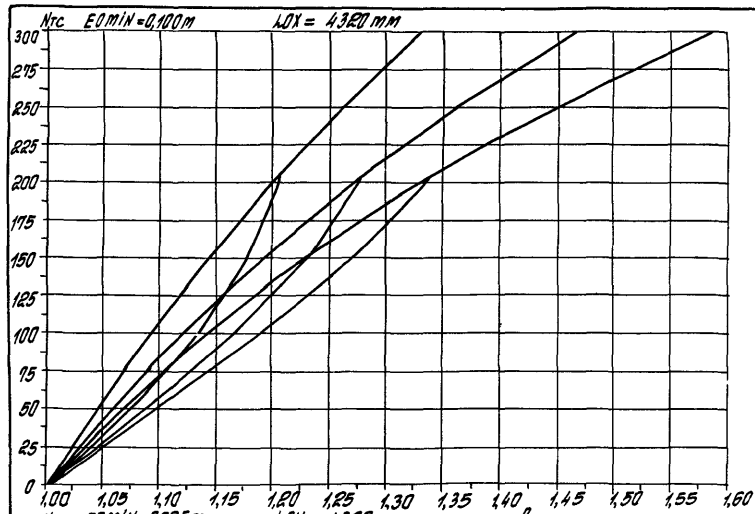

Шкала по ГОСТ 17005-77. Измерения в мм.

1.020.1-4 0-9 002 Aum
147

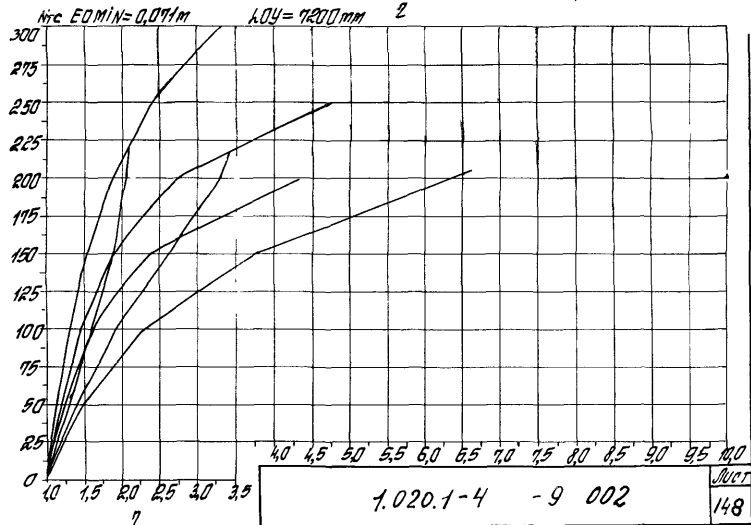
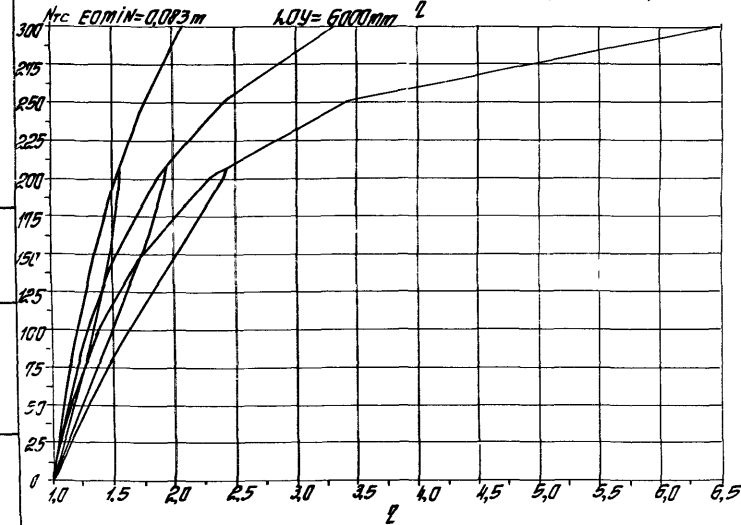
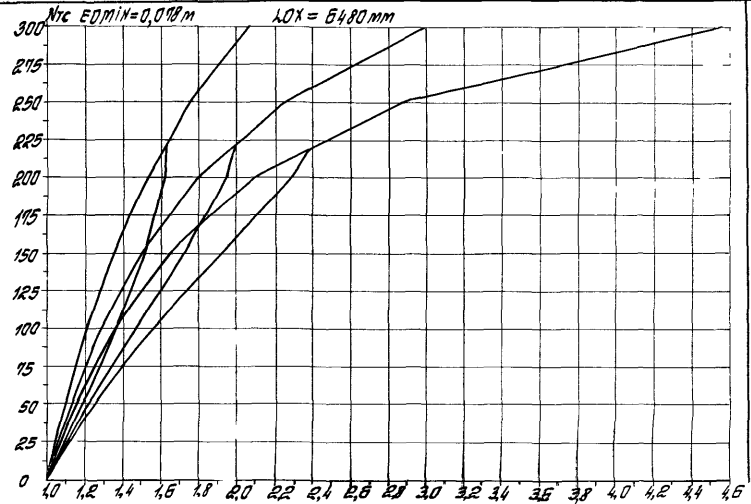
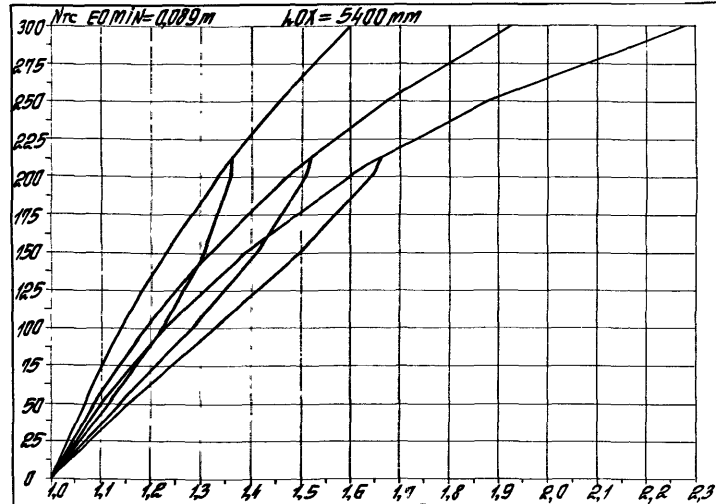

УДАЧА НА ПЛОЩАДИ КОЭФФИЦИЕНТ Л. ОБЪЕМА КОЭФФИЦИЕНТ Л. МАССЫ

4,0 4,5 5,0 5,5 6,0 6,5 7,0 7,5 8,0 8,5 9,0 9,5 10,0
 1.020.1-4 - 9 002 ШЕЛ 148

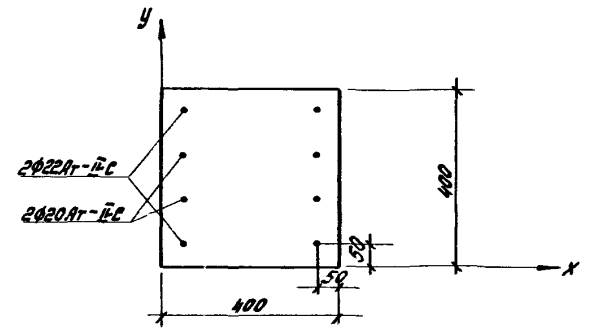
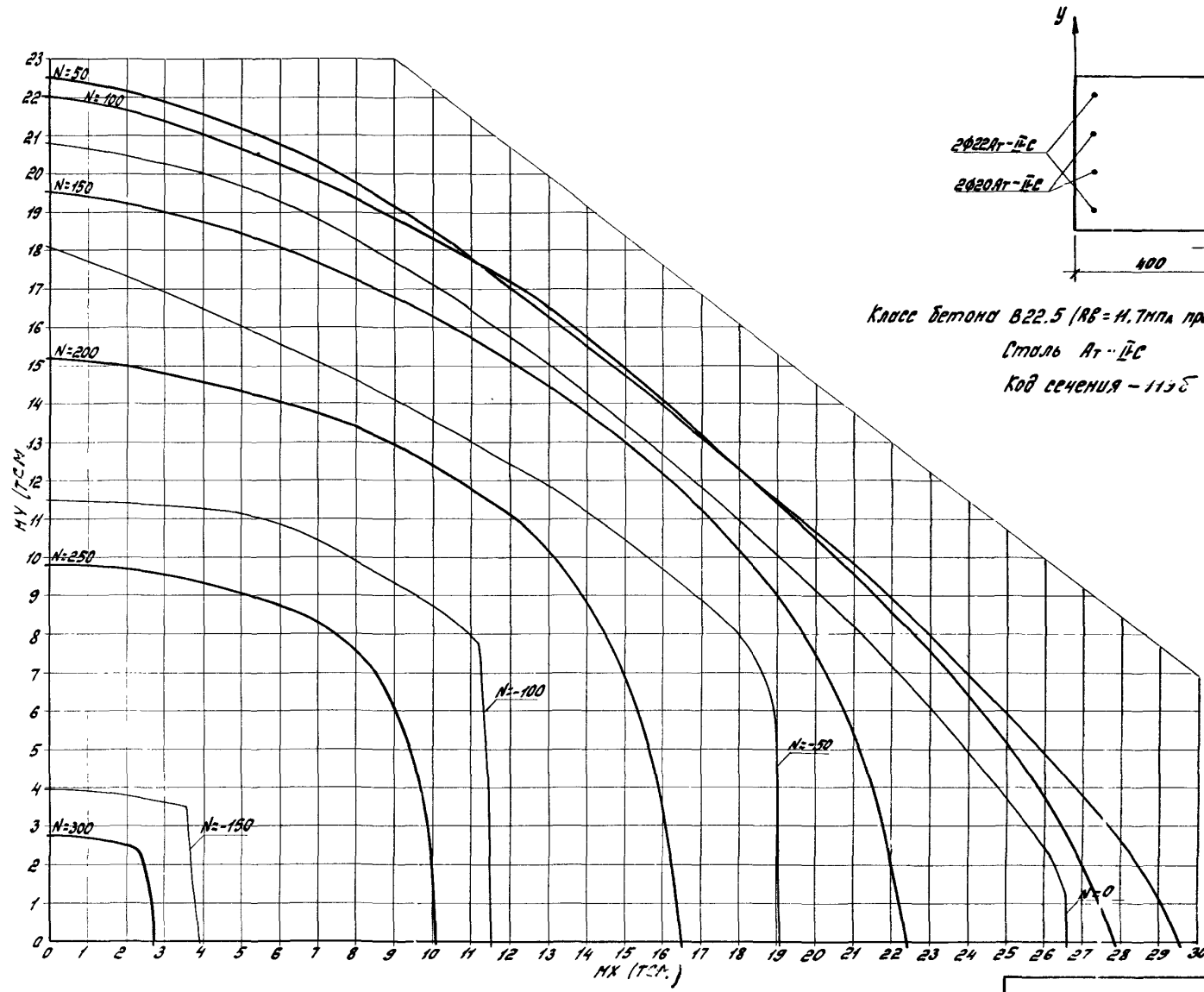

Класс бетона В22.5 ($R_B = 11.7 \text{ МПа}$ при учёте $\gamma_{B2} = 0.90$)
 Сталь Ат-ІІС
 Код сечения - 115Б

1.020. 1-4 0-9 002

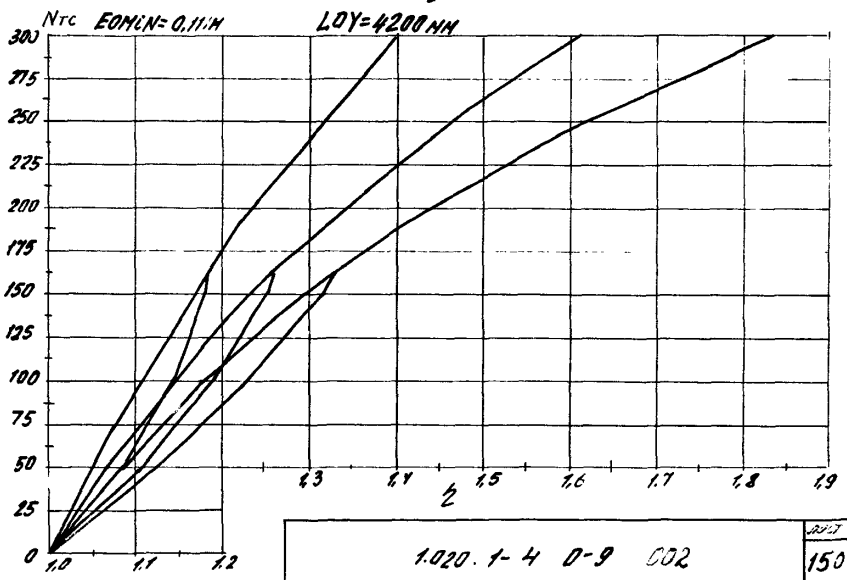
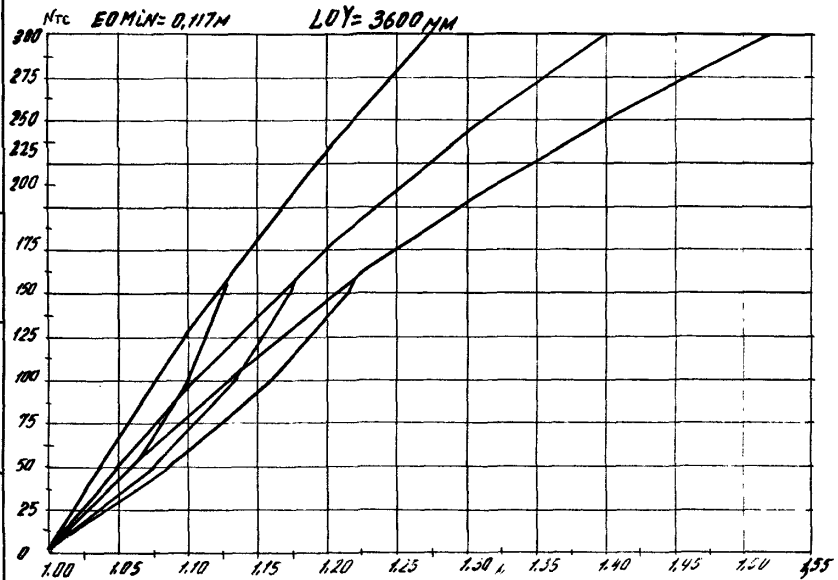
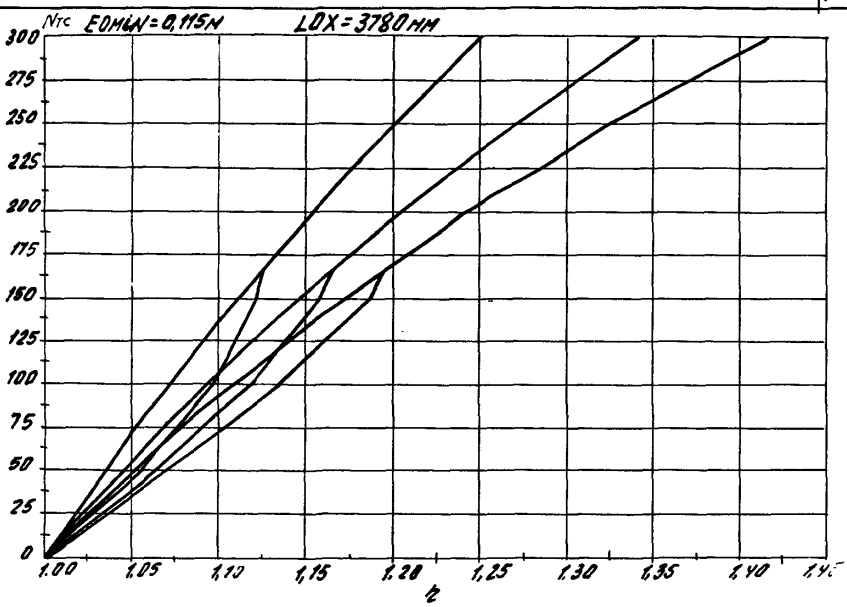
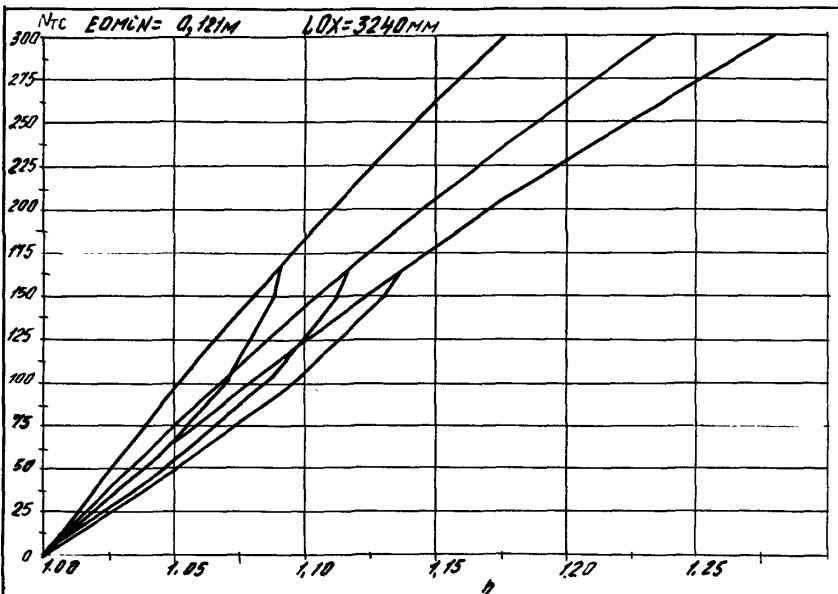

1.020. 1-4 0-9 002 150

Исч. на основании результатов измерений

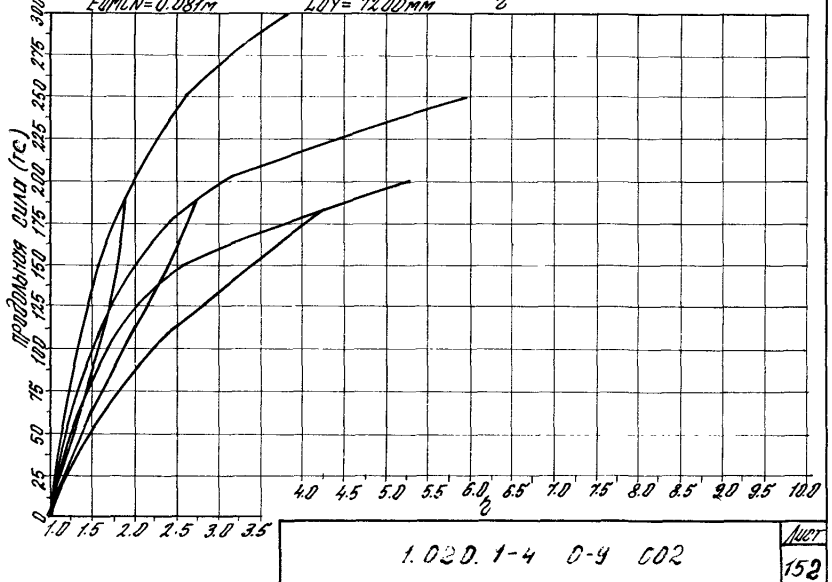
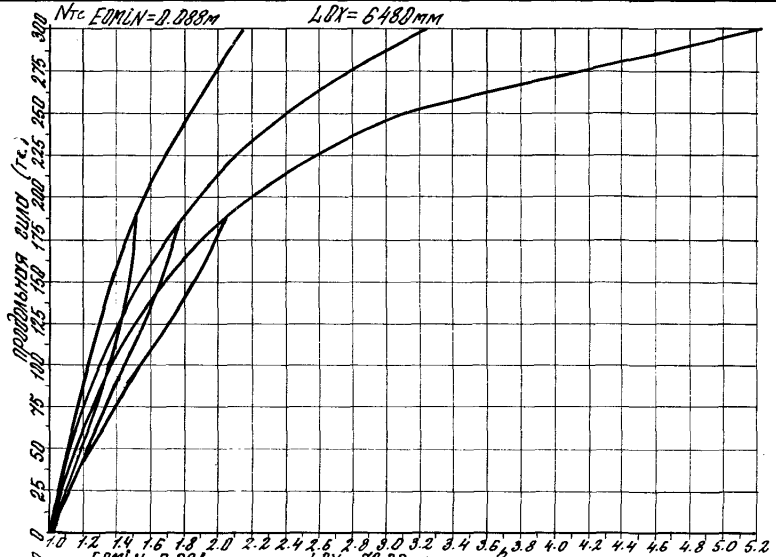
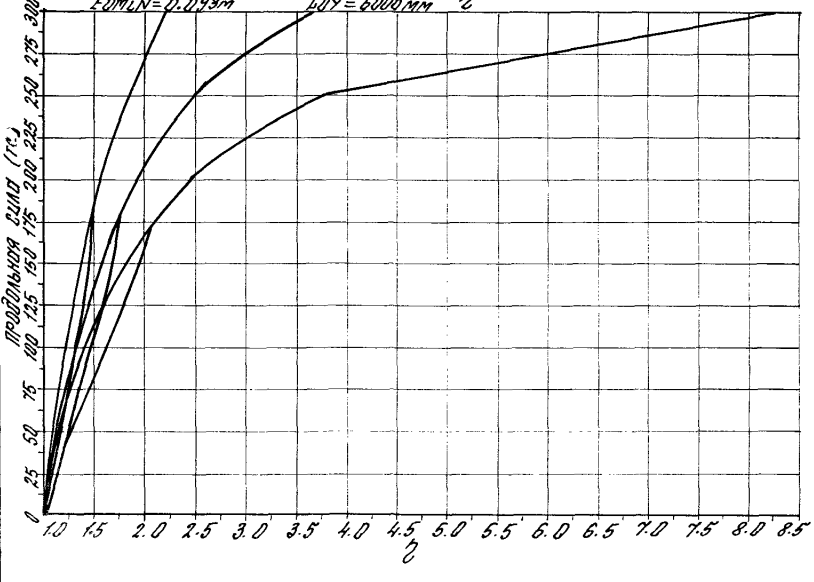
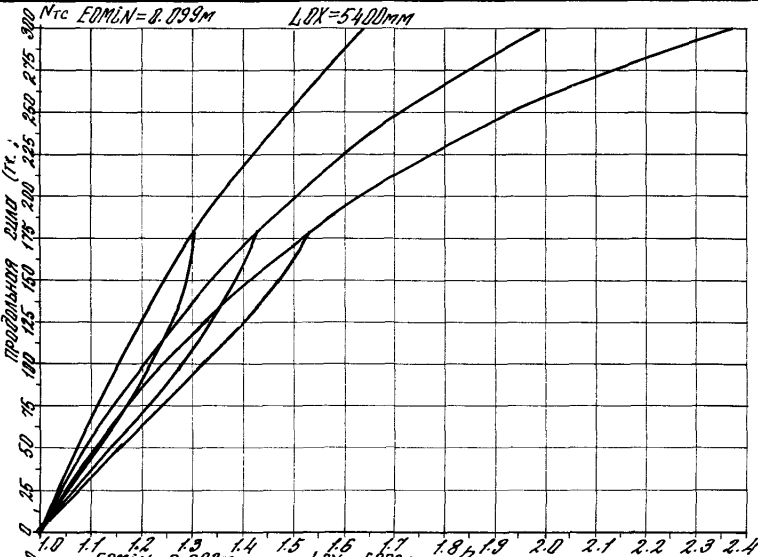

1.020.1-4 0-4 CO2

Исч. 152

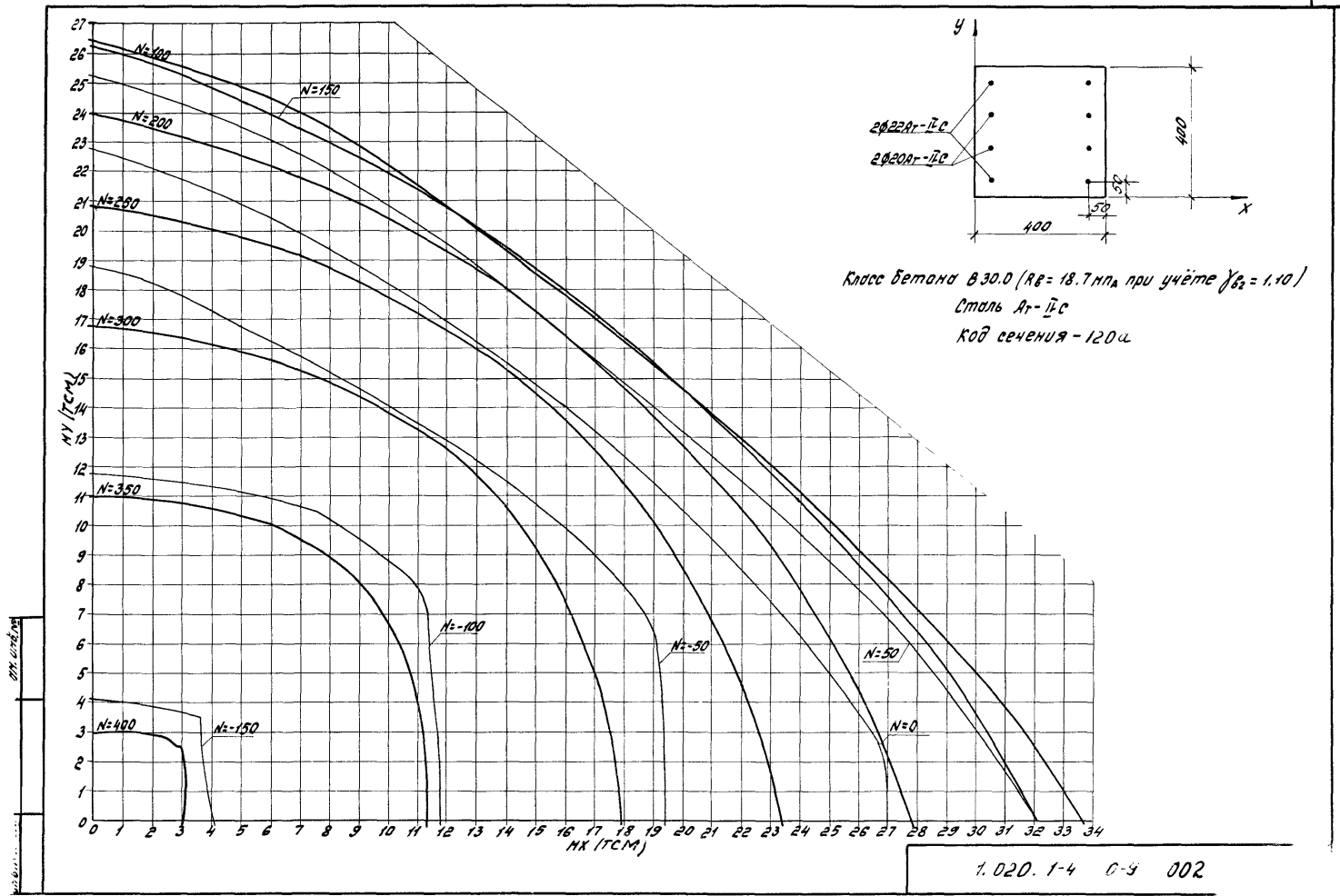

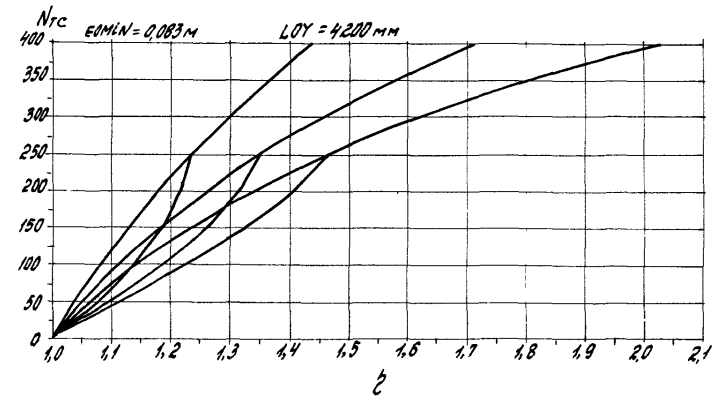
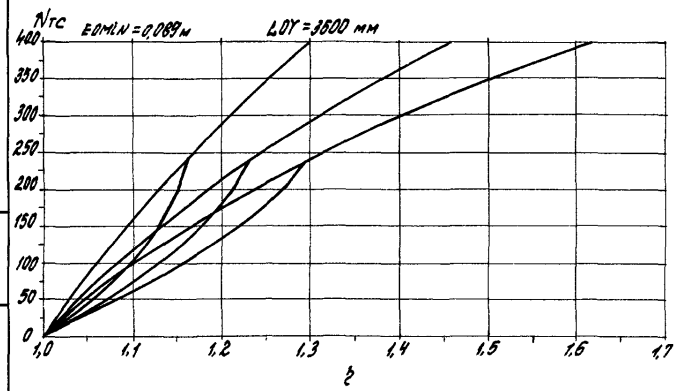
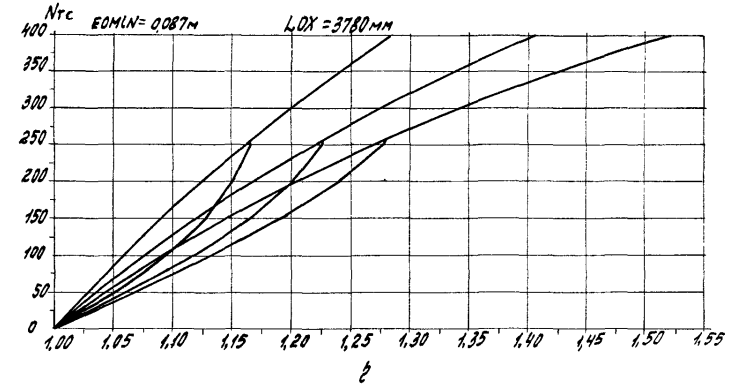
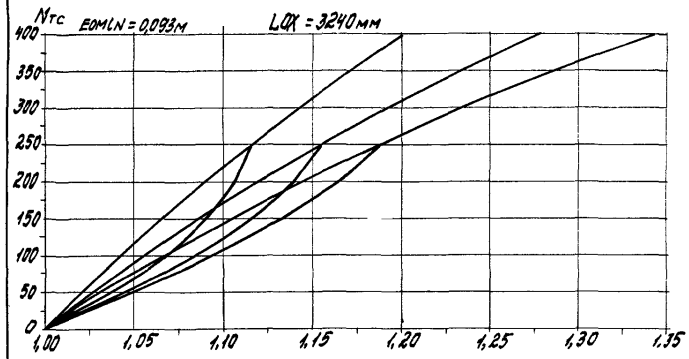

Linh. Noveca (Tehnološki u okviru EOMLN L.083)

1.020.1-4	0-9	002	11/17
			154

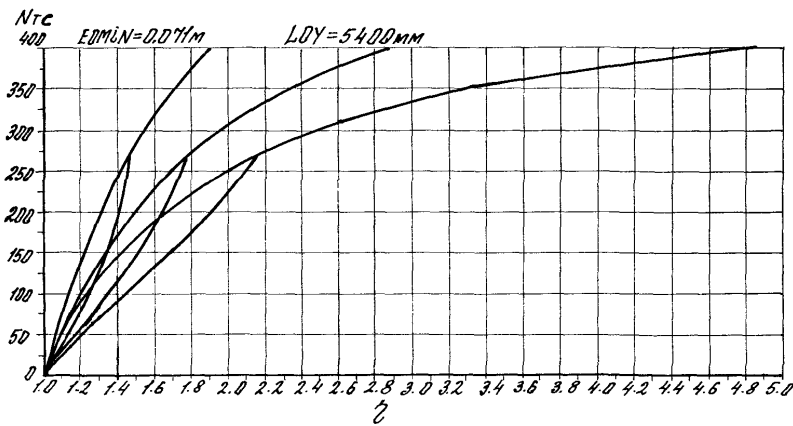
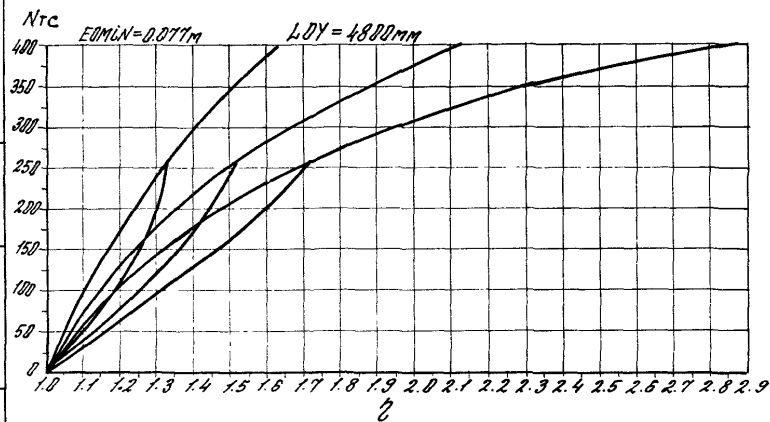
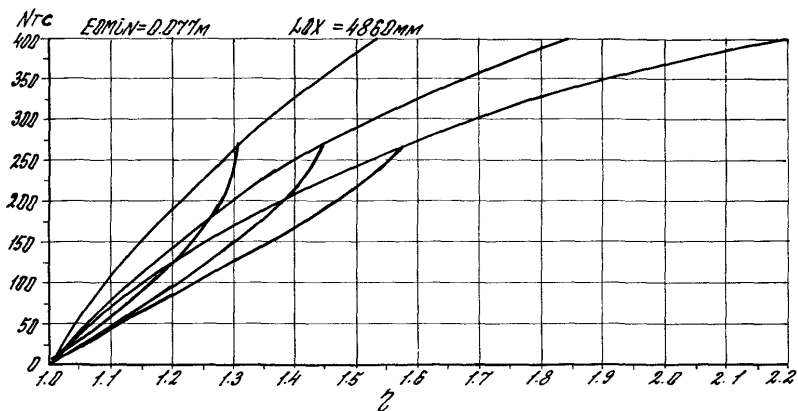
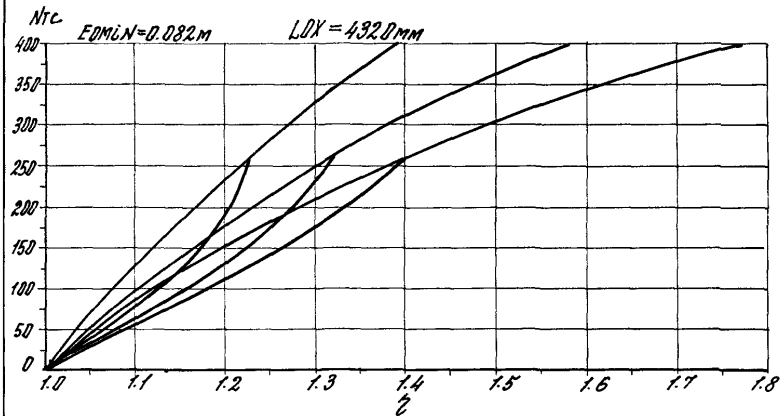

1.023. 1-4 0-9 002

AugT
155

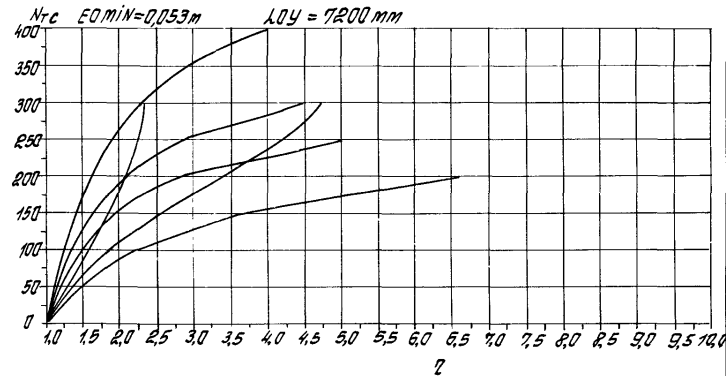
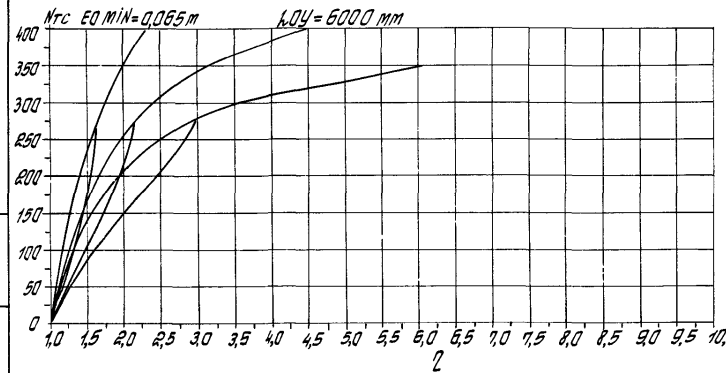
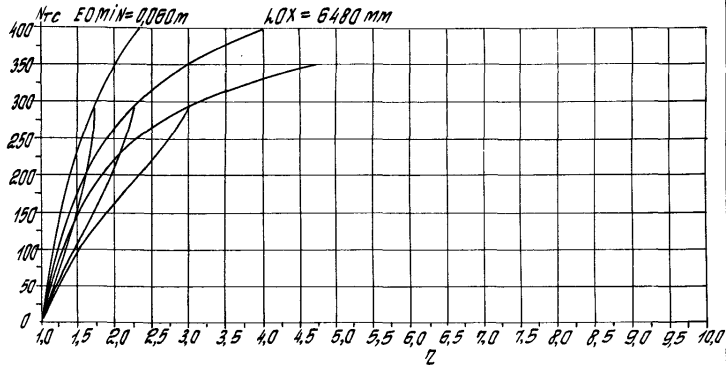
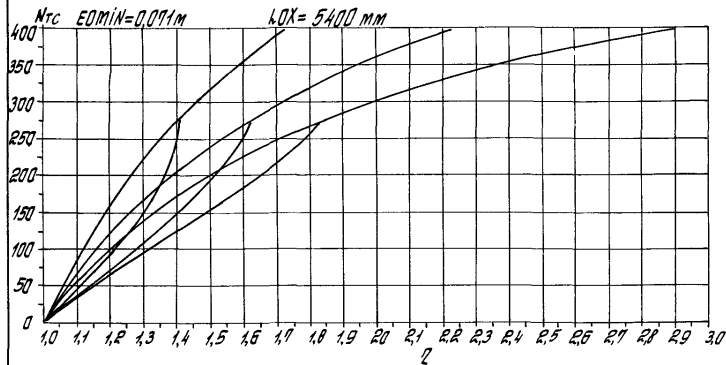

Учеб. № 100. Умножение и деление десятичных дробей

1.020. 1-4 0-9 002

156

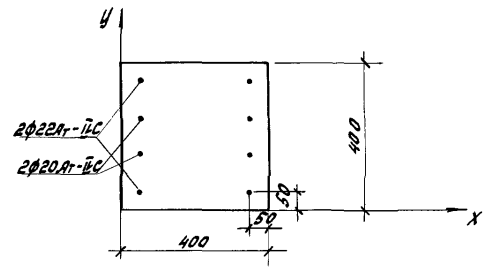
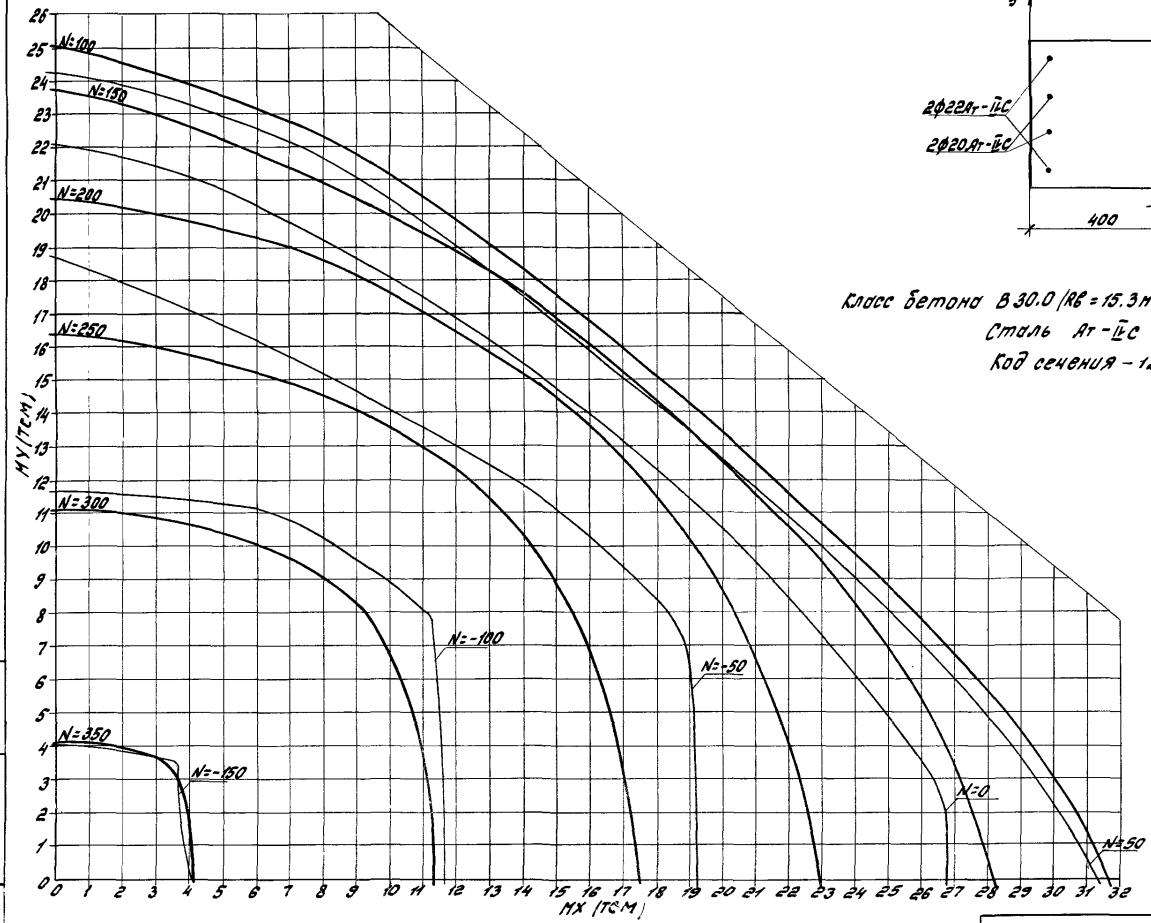

Класс бетона В 30.0 ($R_b = 15.3 \text{ МПа}$ при учёте $\gamma_{b2} = 0.90$)
 Сталь Ar-IIc
 Код сечения - 120Б

1.020.1-4	0-9	002	Лист
			157

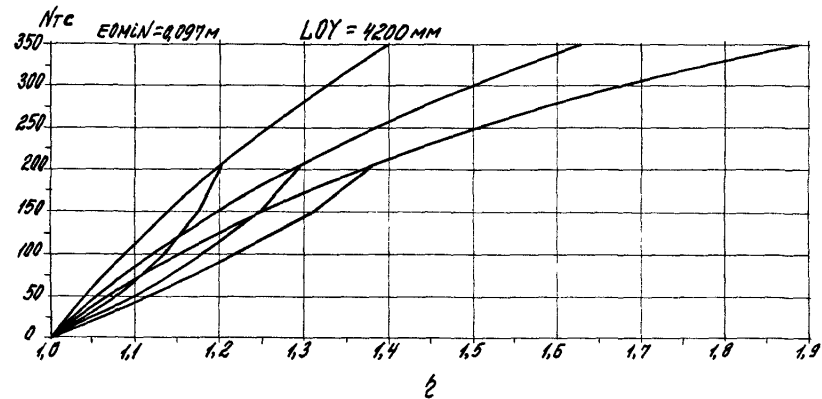
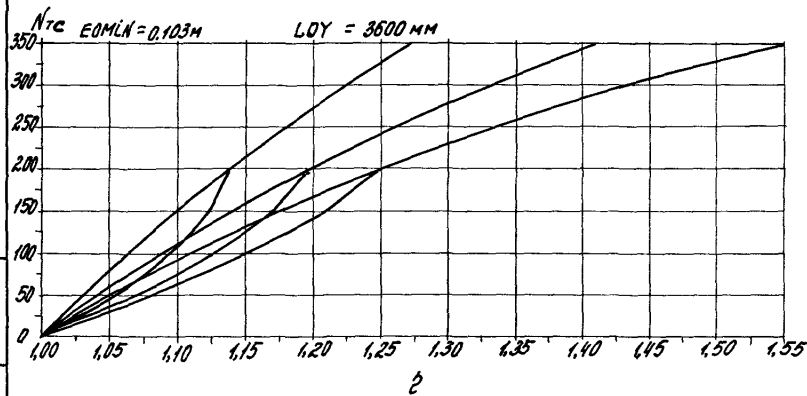
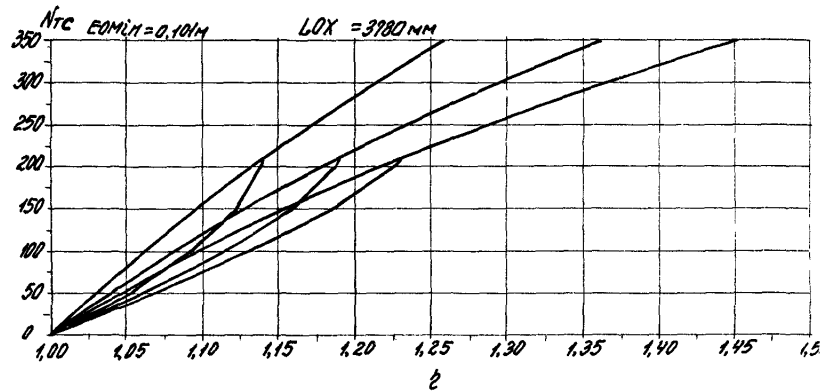
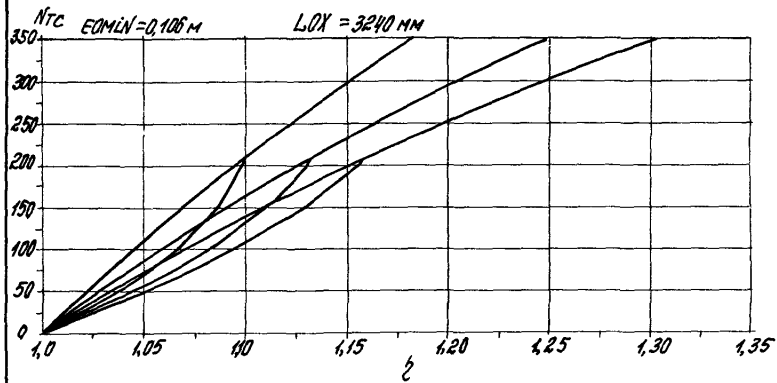

LITHO IN U.S.S.R. BY THE STATE SCIENTIFIC CENTER OF COSMOS

1.020. 1-4 0-9 002	158
--------------------	-----

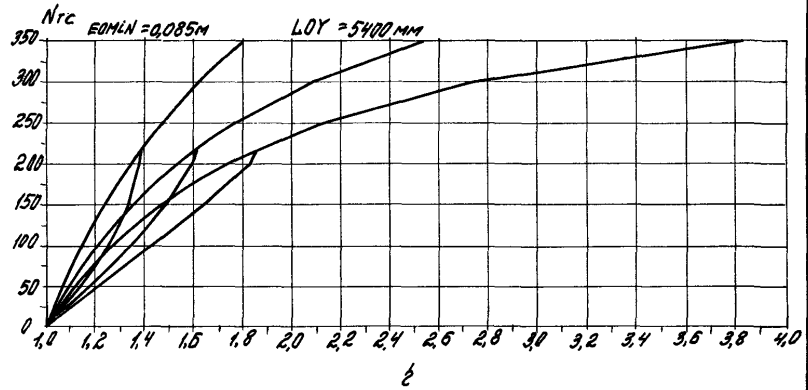
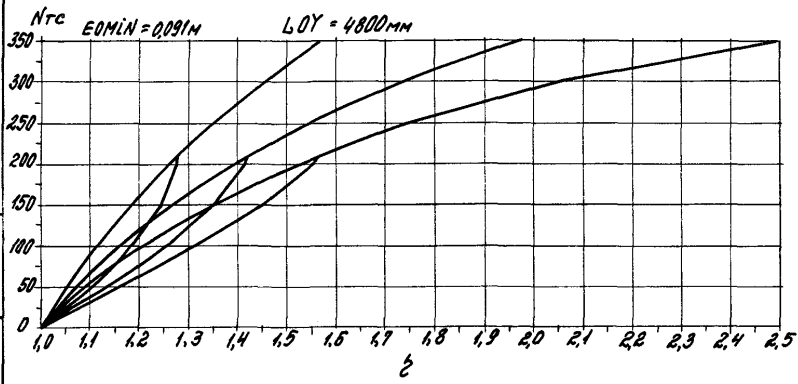
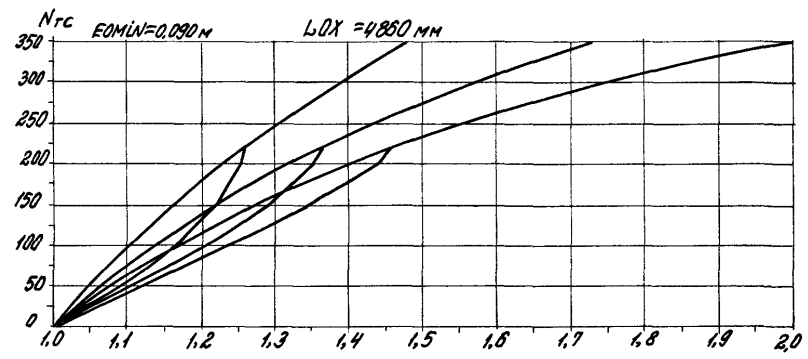
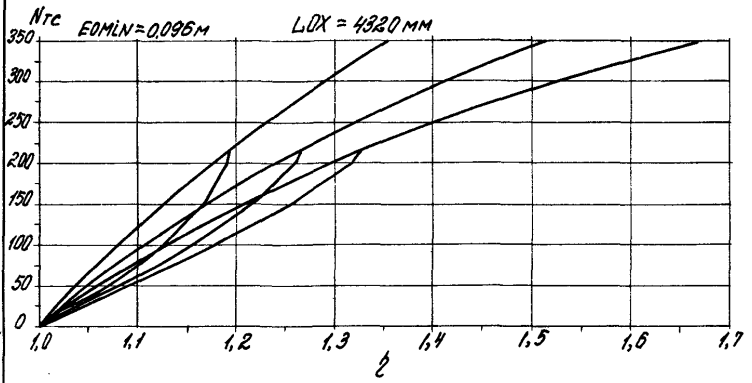

174 175 176 177 178 179 180 181 182 183 184 185 186 187 188 189 190 191 192 193 194 195 196 197 198 199 200 201 202 203 204 205 206 207 208 209 210 211 212 213 214 215 216 217 218 219 220 221 222 223 224 225 226 227 228 229 230 231 232 233 234 235 236 237 238 239 240 241 242 243 244 245 246 247 248 249 250 251 252 253 254 255 256 257 258 259 260 261 262 263 264 265 266 267 268 269 270 271 272 273 274 275 276 277 278 279 280 281 282 283 284 285 286 287 288 289 290 291 292 293 294 295 296 297 298 299 300 301 302 303 304 305 306 307 308 309 310 311 312 313 314 315 316 317 318 319 320 321 322 323 324 325 326 327 328 329 330 331 332 333 334 335 336 337 338 339 340 341 342 343 344 345 346 347 348 349 350 351 352 353 354 355 356 357 358 359 360 361 362 363 364 365 366 367 368 369 370 371 372 373 374 375 376 377 378 379 380 381 382 383 384 385 386 387 388 389 390 391 392 393 394 395 396 397 398 399 400 401 402 403 404 405 406 407 408 409 410 411 412 413 414 415 416 417 418 419 420 421 422 423 424 425 426 427 428 429 430 431 432 433 434 435 436 437 438 439 440 441 442 443 444 445 446 447 448 449 450 451 452 453 454 455 456 457 458 459 460 461 462 463 464 465 466 467 468 469 470 471 472 473 474 475 476 477 478 479 480 481 482 483 484 485 486 487 488 489 490 491 492 493 494 495 496 497 498 499 500

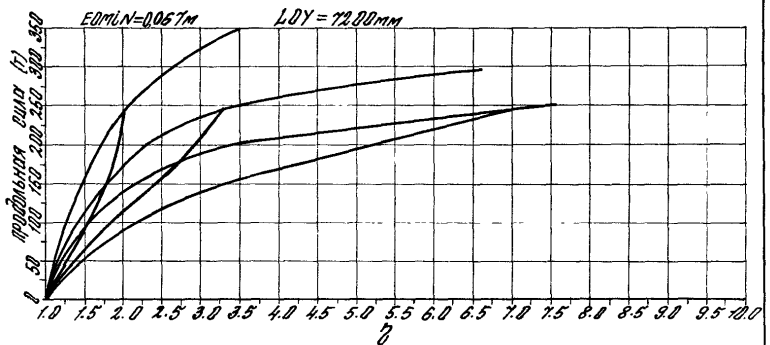
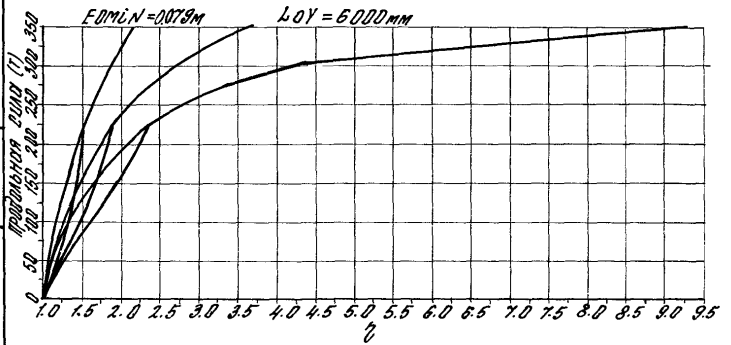
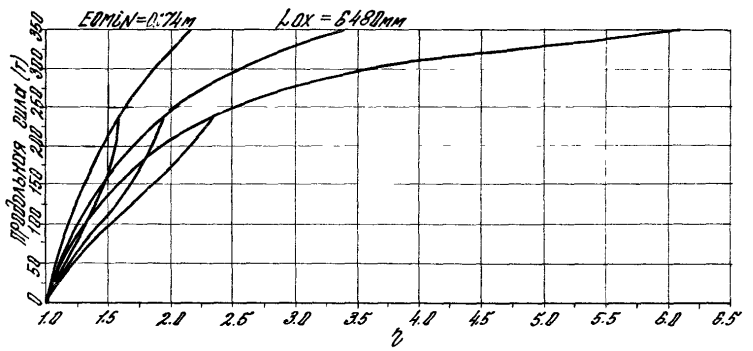
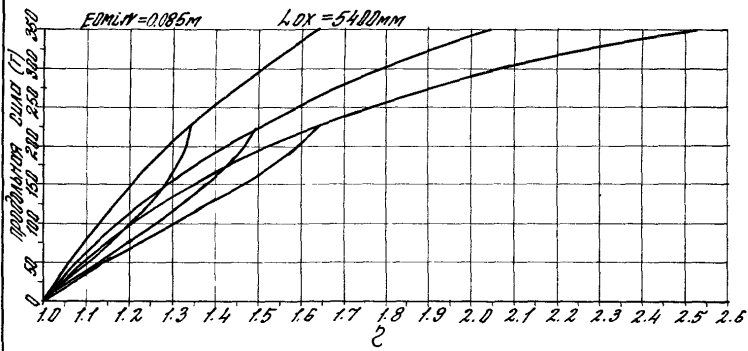

УИЧБ-9070014. Проектная документация. Архив. УИЧБ-9070014

1.020.1-4 0-9 002	Лист 160
-------------------	-------------