



ГОСУДАРСТВЕННЫЙ СТАНДАРТ  
СОЮЗА ССР

# РАСЧЕТЫ БАЛЛИСТИЧЕСКИЕ ИСКУССТВЕННЫХ СПУТНИКОВ ЗЕМЛИ

МЕТОДИКА РАСЧЕТА ЗАТРАТ ТОПЛИВА  
НА МАНЕВРИРОВАНИЕ

ГОСТ 25645.301-83

Издание официальное

Цена 1 р. 30 коп.

ГОСУДАРСТВЕННЫЙ КОМИТЕТ СССР ПО СТАНДАРТАМ  
Москва



# ИСПОЛНИТЕЛИ

Е. А. Зайцев; М. А. Закиров, канд. техн. наук; Г. в. Лебедев; В. А. Модестов, канд. техн. наук. В. А. Понохов;  
И. Г. Пыхова; Л. Н. Степанова

СОГЛАСОВАНО С ГОСУДАРСТВЕННОЙ СЛУЖБОЙ СТАНДАРТНЫХ СПРАВОЧНЫХ ДАННЫХ (протокол от 10 августа 1983 г. № 26)

УТВЕРЖДЕН И ВВЕДЕН В ДЕЙСТВИЕ ПОСТАНОВЛЕНИЕМ Государственного комитета СССР по стандартам от 8 сентября 1983 г. № 4155

Группа Т27

## ПОПРАВКА

к ГОСТ 25645.301—83 Расчеты баллистические искусственных спутников Земли.  
Методика расчета затрат топлива на маневрирование

В каком месте	Напечатано	Должно быть
Пункт 2.2.2	средние затраты топлива за сутки,	$\Delta G_{\text{тн}}^c$ - средние затраты топлива за сутки;
	средние затраты топлива за виток,	$\Delta G_{\text{тн}}^n$ - средние затраты топлива за виток;
	средние затраты характеристической скорости за сутки;	$\Delta V_{\text{хар}}^c$ - средние затраты характеристической скорости за сутки;
	— средние затраты характеристической скорости за виток.	$\Delta V_{\text{хар}}^n$ - средние затраты характеристической скорости за виток.
Таблица 4. Головка	$F_0, 10^{-22} \text{ Вт/м}^2 \text{ Гц}$	$F_0, 10^{-22} \text{ Вт/м}^2 \text{ Гц}$
С. 16. Таблица 4		
Высота 1500 км	4,66 - 05	4,69 - 05
С. 21. Таблица 5		
Высота 1340 км	3,86 - 06	3,85 06
С. 39. Таблица 11		
$H, 450 \text{ км}$	7644 692	7944,692

(ИЭС 11—84)

РАСЧЕТЫ БАЛЛИСТИЧЕСКИЕ ИСКУССТВЕННЫХ  
СПУТНИКОВ ЗЕМЛИ

## МЕТОДИКА РАСЧЕТА ЗАТРАТ ТОПЛИВА НА МАНЕВРИРОВАНИЕ

Artificial Earth satellite ballistic computations.  
Computation methods of manoeuvring propellant expenditureГОСТ  
25645.301—83

ОКСТУ 0080

Постановлением Государственного комитета СССР по стандартам от 8 сентября 1983 г. № 4157 срок введения установлен  
с 01.01.85

Несоблюдение стандарта преследуется по закону

Настоящий стандарт устанавливает методику расчета затрат топлива на маневрирование искусственных спутников Земли (ИСЗ) с целью поддержания заданных параметров их орбиты и предназначен для проектных баллистических расчетов ИСЗ, совершающих полет в диапазоне высот от 120 до 1500 км в течение активного существования более одних суток.

## 1. ОСНОВНЫЕ ПОЛОЖЕНИЯ

1.1. Методика расчета затрат топлива на поддержание заданных параметров орбиты ИСЗ представлена для следующих случаев движения центра масс ИСЗ (далее — движения ИСЗ):

- полет с поддержанием заданной высоты полета;
- полет с поддержанием высоты орбиты в заданном диапазоне высот;
- спуск с круговой орбиты на Землю.

1.2. В стандарте рассматривают орбиты ИСЗ, близкие к круговым (далее — круговые орбиты). Орбиты ИСЗ принимают кеплеровыми с элементами, равными элементам средней орбиты. Средняя орбита ИСЗ — кеплерова орбита, аппроксимирующая орбиту ИСЗ в нормальном поле притяжения Земли без учета сопротивления атмосферы.

1.3. Параметры движения ИСЗ рассчитывают в невозмущенной атмосфере в орбитальной системе координат для ИСЗ, сохраняющих постоянный баллистический коэффициент согласования  $S_c$  действующих на него сил.

Орбитальная система координат ( $Orpb$ ) имеет начало в центре масс ИСЗ:

ось  $Or$  направлена по радиусу-вектору ИСЗ в сторону его увеличения;

ось  $Ob$  нормальна плоскости орбиты ИСЗ и направлена в сторону, обратную вектору кинетического момента движения ИСЗ;

ось  $Op$  лежит в плоскости орбиты, направлена по нормали к радиусу-вектору, положительное направление ее совпадает с направлением движения ИСЗ.

1.4. Возмущения движения ИСЗ за счет неучета коэффициентов разложения потенциала аномалии поля земного притяжения приняты равными нулю.

1.5. Затраты топлива определяют при плотности атмосферы по ГОСТ 25645.101—83. Для расчета предельных затрат топлива следует учитывать вариации плотности атмосферы, определяемые по ГОСТ 25645.101—83, ГОСТ 25645.102—83 и ГОСТ 25645.115—84.

1.6. Расчет затрат топлива проводят по схеме полета ИСЗ, которую разбивают на типовые участки, принимая затраты топлива на этих участках независимыми.

1.7. Затраты топлива на поддержание заданных параметров орбиты состоят из затрат на коррекцию параметров орбиты и на управление движением ИСЗ относительно его центра масс.

При расчете затрат топлива на управление движением ИСЗ его аэродинамические коэффициенты в зависимости от ориентации определяют по методике, приведенной в обязательном приложении 1.

1.8. При расчете затрат топлива на поддержание заданной высоты орбиты принимают, что корректирующие импульсы скорости (далее—импульсы скорости) ориентированы по трансверсали, а точки их приложения расположены на линии апсид средней орбиты.

При расчете затрат топлива для спуска с круговой орбиты на Землю принимают, что импульс скорости ориентирован в плоскости орбиты, а угол его наклона определяют из условия минимума затрат характеристической скорости на коррекцию.

1.9. Элементы средней орбиты  $a_c, e_c, \omega_c, i_c$ , а также другие параметры средней орбиты вычисляют через элементы оскулирующей орбиты  $a_o, e_o, \omega_o, i_o$ , взятые в восходящем узле, по формулам (1)—(14), приведенным в табл. 1, при значениях параметров Земли  $a_e, \alpha, \mu, g$ , приведенных в справочном приложении 2.

Таблица 1

Наименование параметра	Уравнение для вычисления параметра
Большая полуось средней орбиты	$a_c = a_o - \frac{e}{a_o \mu} \left( 1 - \frac{\sin^2 i_o}{2} \right) \quad (4)$
Средний эксцентриситет	$e_c = \sqrt{\frac{(a_o e_o \cos \omega_o - \frac{e}{a_o \mu} \left( 1 - \frac{2}{3} \sin^2 i_o \right))^2 + (a_o e_o \sin \omega_o)^2}{a_c}} \quad (2)$
Средний аргумент перигея	$\omega_c = \text{Arccos}(\cos \omega_c; \sin \omega_c), \quad 0 \leq \omega_c < 360^\circ \quad (3)$
Функция аргумента перигея	$\sin \omega_c = \frac{a_o e_o \sin \omega_o}{a_c e_c} \quad (4)$
	$\cos \omega_c = \frac{a_o e_o \cos \omega_o - \frac{e}{a_o \mu} \left( 1 - \frac{2}{3} \sin^2 i_o \right)}{a_c e_c} \quad (5)$
Средний период	$T_c = \frac{2\pi \cdot a_c^{-3/2}}{\sqrt{\mu}} \quad (6)$
Радиус перигея средней орбиты	$r_{c\pi} = a_c(1 - e_c) \quad (7)$
Радиус апогея средней орбиты	$r_{c\alpha} = a_c(1 + e_c) \quad (8)$
Абсолютная скорость в перигее средней орбиты	$V_{c\pi} = \sqrt{\frac{\mu(1+e_c)}{a_c(1-e_c)}} \quad (9)$
Абсолютная скорость в апогее средней орбиты	$V_{c\alpha} = \sqrt{\frac{\mu(1-e_c)}{a_c(1+e_c)}} \quad (10)$
Средняя высота орбиты	$h_c = a_c - R_{ЗЗ} \quad (11)$
Средний радиус орбиты	$r_c = a_c \quad (12)$
Средняя скорость на орбите	$V_c = \sqrt{\frac{\mu}{r_c}} \quad (13)$
Средний радиус Земли при наклонении орбиты	$R_{ЗЗ} = a_e \left( 1 - \frac{\alpha \cdot \sin^2 i_o}{2} \right) \quad (14)$



**Примечания:**

1. Среднее наклонение орбиты

$$i_c = i_0.$$

2. При неизвестном наклонении орбиты  $i_0$  принято, что  $R_{ЗС} = 6368687$  м.3. Значения среднего радиуса Земли  $R_{ЗС}$  в зависимости от наклонения орбиты ИСЗ  $i_0$ , вычисленные по формуле (14), приведены в справочном приложении 2.1.10. Баллистический коэффициент согласования  $S_c$  вычисляют по формуле

$$S_c = S_k - \frac{P_n}{\lambda \cdot \rho_w \cdot m_0 \cdot V_c^2}, \quad (15)$$

где  $S_k$  — конструктивный баллистический коэффициент ИСЗ, вычисляемый по формуле

$$S_k = \frac{C_{x_0} \cdot F_m}{k^2 m_0^2},$$

где  $C_{x_0}$  — номинальное значение коэффициента аэродинамического сопротивления  $C_x$  на типовом участке полета ИСЗ; $F_m$  — площадь миделава сечения ИСЗ, к которой отнесены аэродинамические коэффициенты ИСЗ; $m_0$  — масса ИСЗ в начале типового участка полета, вычисляемая по формуле

$$m_0 = \frac{G_0}{g_0},$$

где  $G_0$  — вес ИСЗ в начале типового участка; $g_0$  — ускорение силы тяжести в точке запуска носителя ИСЗ; $P_n$  — проекция составляющей силы тяги двигателей ориентации и стабилизации ИСЗ на ось  $oz$  орбитальной системы координат осредненная на типовом участке полета с учетом аэродинамических характеристик ИСЗ; $\lambda$  — коэффициент, вычисляемый по формуле

$$\lambda = 1 - \frac{2\omega_z \cdot r_c}{V_c} \cdot \cos i_c,$$

где  $\omega_z$  — угловая скорость вращения Земли; $\rho_w$  — плотность верхней атмосферы по ГОСТ 25645.101—83.Номинальное значение  $C_{x_0}$  определяют осреднением значения  $C_x$ , рассчитанного по изменениям углов ориентации осей ИСЗ относительно осей орбитальной системы координат и углов ориентации подвижных элементов конструкции ИСЗ, заданных на типовом участке схемы полета ИСЗ.При отсутствии данных об изменении углов ориентации осей ИСЗ и подвижных элементов, значение  $C_x$  осредняют во всем возможном диапазоне их изменения.

## 2. МЕТОДИКА РАСЧЕТА ЗАТРАТ ТОПЛИВА НА ПОДДЕРЖАНИЕ ЗАДАНЫХ ПАРАМЕТРОВ ОРБИТ ИСЗ

### 2.1. Расчет суммарных затрат топлива

Суммарные затраты топлива на поддержание заданных параметров орбиты на типовом участке полета ИСЗ вычисляют по формуле

$$\Delta G_{\Sigma} = \Delta G_{\text{тк}} + \Delta G_{\text{тр}}, \quad (16)$$

где  $\Delta G_{\text{тк}}$  — затраты топлива на коррекцию, вычисляемые по формуле

$$\Delta G_{\text{тк}} = \Delta G_{\text{тн}} + \Delta G_{\text{тв}},$$

где  $\Delta G_{\text{тн}}$  — затраты топлива двигателями коррекции на приращение скорости ИСЗ (характеристической скорости); $\Delta G_{\text{тв}}$  — непроизводительные затраты топлива двигательной установки (ДУ) за время выхода на режим и после выключения, когда тяга ее равна нулю; $\Delta G_{\text{тс}}$  — затраты топлива на управление движением ИСЗ относительно его центра масс (на стабилизацию и ориентацию ИСЗ), определяемые с учетом аэродинамических коэффициентов сил и моментов.Затраты топлива  $\Delta G_{\text{тн}}$  вычисляют по формуле

$$\Delta G_{\text{тн}} = G_0 \left( 1 - \exp \left( \frac{|\Delta V_{\text{тп}}|}{V_{\text{эф}} \cdot g_0} \right) \right), \quad (17)$$

где  $\Delta V_{\text{хар}}$  — затраты характеристической скорости на коррекцию на типовом участке, вычисляемые по формуле

$$\Delta V_{\text{хар}} = \sum_{i=1}^n |\Delta V_i|,$$

где  $\Delta V_i$  — номинальные значения импульсов скорости;

$n$  — число импульсов скорости на типовом участке;

$I_{\text{эф}}$  — эффективный удельный импульс ДУ, вычисляемый по формуле

$$I_{\text{эф}} = \frac{|\vec{P}|}{q},$$

где  $\vec{P}$  — вектор тяги ДУ;

$q$  — секундный расход топлива ДУ на режиме установившейся тяги.

2.2. Расчет затрат топлива на поддержание заданной высоты полета

2.2.1. Номинальные затраты топлива на поддержание высоты полета ИСЗ (периода обращения ИСЗ)  $\Delta G_{\text{ти}}$  равны затратам на компенсацию аэродинамического торможения ИСЗ атмосферой при отсутствии других возмущений.

2.2.2. Номинальные затраты топлива и характеристической скорости для компенсации аэродинамического торможения ИСЗ атмосферой на круговой орбите вычисляются по формулам:

$$\Delta G_{\text{ти}}^c = \frac{C_x \cdot F_m \cdot \mu \cdot \rho_m}{2r_c \cdot I_{\text{эф}}} \cdot 86400; \quad (18)$$

$$\Delta G_{\text{ти}}^s = \frac{C_x \cdot F_m \cdot V \cdot \mu \cdot \rho_m \cdot \pi}{I_{\text{эф}}}; \quad (19)$$

$$\Delta V_{\text{хар}}^c = \frac{\mu \cdot S_k \cdot \rho_m \cdot 86400}{r_c}; \quad (20)$$

$$\Delta V_{\text{хар}}^s = 2\pi \sqrt{\mu \cdot r_c \cdot \rho_m \cdot S_k}; \quad (21)$$

где  $\Delta G_{\text{ти}}^c$  — средние затраты топлива за сутки;

$\Delta G_{\text{ти}}^s$  — средние затраты топлива за виток;

$\Delta V_{\text{хар}}^c$  — средние затраты характеристической скорости за сутки;

$\Delta V_{\text{хар}}^s$  — средние затраты характеристической скорости за виток.

2.2.3. При заданных конструктивных характеристиках ИСЗ, приведенных в табл. 2, для десяти фиксированных уровней солнечной активности:  $F_0 = 65; 75; 100; 125; 150; 175; 200; 225; 250; 275$  (в  $10^{-22}$  Вт/(м<sup>2</sup>·Гц)) в зависимости от высоты полета ИСЗ приведены номинальные затраты топлива и характеристической скорости для:

плотности атмосферы  $\rho_m$  по ГОСТ 25645.101—83 — в табл. 3 и табл. 6;

плотности атмосферы  $\rho_m$  с учетом ее предельного отклонения  $\Delta \rho_{c \text{ max}}$  — в табл. 4 и табл. 7;

плотности атмосферы  $\rho_m$  с учетом ее предельного отклонения  $\Delta \rho_{c \text{ min}}$  — в табл. 5 и табл. 8.

Таблица 2

Конструктивная характеристика ИСЗ	Обозначение	Значение
Баллистический коэффициент, м <sup>2</sup> /кгс·с <sup>2</sup>	$S_k$	0,01
Аэродинамическая характеристика, м <sup>2</sup>	$C_x \cdot F_m$	30
Эффективный удельный импульс, кгс·с/кгс	$I_{\text{эф}}$	300

2.2.4. Номинальные затраты топлива и характеристической скорости для других значений конструктивных характеристик ИСЗ ( $S_k', C_x', F_m', I_{\text{эф}}'$ ) вычисляются по формулам:

$$\Delta G_{\text{ти}}' = \frac{S_k'}{0,01} \cdot \Delta G_{\text{ти}},$$

$$\Delta G'_{\text{тн}} = \frac{(C'_x \cdot F'_m)}{30} \Delta G_{\text{тн}}$$

$$\Delta G'_{\text{тн}} = \frac{300}{I'_{\text{эф}}} \Delta G_{\text{тн}}$$

$$\Delta V'_{\text{хар}} = \frac{S'_k}{0,01} \Delta V_{\text{хар}}$$

$$\Delta V'_{\text{хар}} = \frac{(C'_x \cdot F'_m)}{30} \Delta V_{\text{хар}}$$

2.2.5. Предельные отклонения среднесуточных и средневитковых затрат топлива и характеристической скорости вычисляют по формулам:

$$\Delta G_{\text{тн}}^{\text{с max}} = \Delta G_{\text{тн}}^{\text{с}} \left( 1 + \frac{\Delta \rho_{\text{м max}}}{\rho_{\text{м}}} \right),$$

$$\Delta G_{\text{тн}}^{\text{с min}} = \Delta G_{\text{тн}}^{\text{с}} \left( 1 - \frac{\Delta \rho_{\text{м min}}}{\rho_{\text{м}}} \right),$$

$$\Delta V_{\text{хар}}^{\text{с max}} = \Delta V_{\text{хар}}^{\text{с}} \left( 1 + \frac{\Delta \rho_{\text{м max}}}{\rho_{\text{м}}} \right),$$

$$\Delta V_{\text{хар}}^{\text{с min}} = \Delta V_{\text{хар}}^{\text{с}} \left( 1 - \frac{\Delta \rho_{\text{м min}}}{\rho_{\text{м}}} \right),$$

где  $\Delta \rho_{\text{м max}}$  и  $\Delta \rho_{\text{м min}}$  — максимальное и минимальное отклонения плотности атмосферы  $\rho_{\text{м}}$  за сутки.

2.3. Расчет затрат топлива на поддержание высоты орбиты в заданном диапазоне высот

2.3.1. Схема полета ИСЗ определяет заданный диапазон высот полета ИСЗ: верхнюю границу диапазона  $h_{\text{max}}$  и нижнюю границу диапазона ( $h_{\text{max}} - \Delta h$ ), где  $\Delta h$  — высота слоя, в котором поддерживают орбиту ИСЗ. Значение  $\Delta h$  определяют по схеме полета или из условий минимума затрат топлива.

2.3.2. Поддержание высоты орбиты ИСЗ в заданном диапазоне осуществляют с помощью двухимпульсных коррекций, исполняемых периодически (далее — циклических коррекций). Оба импульса циклической коррекции исполняют на одном витке полета ИСЗ.

2.3.3. Интервал времени между двумя последовательными коррекциями (далее — цикл) вычисляют по формуле

$$\Delta t = \frac{F(h_{\text{max}}) - F(h_{\text{max}} - \Delta h)}{S_c}, \quad (22)$$

где  $F(h)$  вычисляют по ГОСТ 25645.101—83.

2.3.4. Затраты топлива  $\Delta G_{\text{тн}}^u$  и характеристической скорости  $\Delta V_{\text{хар}}$  за цикл на одну двухимпульсную коррекцию вычисляют по формулам:

$$\Delta G_{\text{тн}}^u = G_0 \left( 1 - \exp \left( \frac{-\Delta V_{\text{хар}}}{J_{\text{эф}} \cdot g_0} \right) \right); \quad (23)$$

$$\begin{aligned} \Delta V_{\text{хар}} = \Delta V_1 + \Delta V_2 = & \sqrt{\frac{\mu}{R_0 - \Delta h}} \cdot \left( \sqrt{\frac{R_0}{R_0 - \frac{\Delta h}{2}}} - 1 \right) + \\ & + \sqrt{\frac{\mu}{R_0}} \left( 1 - \sqrt{\frac{R_0 - \Delta h}{R_0 - \frac{\Delta h}{2}}} \right), \end{aligned} \quad (24)$$

где  $\Delta V_1$ ,  $\Delta V_2$  — трансверсальные импульсы скорости циклической коррекции;

$$R_0 = R_{\text{зс}} + h_{\text{max}}$$

2.3.5. Число циклов коррекции за заданный интервал времени полета  $T$  вычисляют методом итераций по рекуррентной формуле

$$n = n_0 - \lambda_T \left( \frac{1}{\Delta \bar{G}_{\text{тн}}^u \cdot \Delta \bar{G}_{\text{тн}}} \left( (\Delta \bar{G}_{\text{тн}}^u + \Delta \bar{G}_{\text{тн}}) (1 - (1 - \Delta \bar{G}_{\text{тн}}^u)^{n+1}) - \frac{T}{\Delta t} \Delta \bar{G}_{\text{тн}}^u \right) - (n+1) \right), \quad (25)$$

где  $n_0$  — значение  $n$ , полученное на предыдущей итерации:

$$\Delta \bar{G}_{\text{тн}}^n = \frac{\Delta G_{\text{тн}}^n}{G_0};$$

$$\Delta \bar{G}_{\text{тн}} = \frac{\Delta G_{\text{тн}} + \Delta G_{\text{ст}}}{G_0},$$

где  $\Delta G_{\text{ст}}$  — затраты топлива на стабилизацию во время работы ДУ коррекции;

$$\lambda_{\text{т}} = \frac{1}{\frac{\Delta \bar{G}_{\text{тн}}^n + \Delta \bar{G}_{\text{тн}}}{\Delta \bar{G}_{\text{тн}}^n \cdot \Delta \bar{G}_{\text{тн}}} \ln(1 - \Delta \bar{G}_{\text{тн}}^n) - 1}.$$

2.3.6. Затраты топлива за интервал времени полета вычисляют по формуле

$$\Delta G_{\text{тн}} = n(\Delta G_{\text{тн}}^n + \Delta G_{\text{тн}} + \Delta G_{\text{ст}}). \quad (26)$$

Средние затраты топлива за сутки  $\Delta G_{\text{тн}}^c$  вычисляют по формуле

$$\Delta G_{\text{тн}}^c = \frac{\Delta G_{\text{тн}}}{T}.$$

Пример расчета затрат топлива на поддержание высоты орбиты ИСЗ в заданном диапазоне высот приведен в справочном приложении 3.

2.4. Расчет затрат топлива на спуск с круговой орбиты на Землю

2.4.1. Траектория спуска ИСЗ с круговой орбиты на Землю включает следующие участки: торможение до схода с орбиты с помощью импульса скорости;

полет по эллиптической траектории до входа в плотные слои атмосферы при пересечении ее условной границы  $r_{\text{ат}}$ ;

движение в плотных слоях атмосферы.

2.4.2. На условной границе атмосферы скорость на эллиптической траектории  $V_{\text{вх}}$  и угол траектории  $\Theta_{\text{вх}}$  определяют по следующим условиям полета:

перегрузки при полете в плотных слоях атмосферы на высотах менее 100 км;

термодинамическому нагреву;

району рассеивания возможных точек падения ИСЗ.

2.4.3. Импульс скорости ориентируют в плоскости орбиты ИСЗ под углом  $\phi_{\text{т}}$  к направлению вектора орбитальной скорости  $\vec{V}_c$ . Полагают, что изменение скорости при коррекции происходит мгновенно. Значения  $\Delta V_{\text{хар}}$  и  $\phi_{\text{т}}$  определяют из условия минимальных затрат характеристической скорости для обеспечения заданного значения  $\Theta_{\text{вх}}$  по формулам:

$$\Delta V_{\text{хар}} = V_c \cdot \Delta V_{\text{т}}, \quad (27)$$

где

$$\text{импульс скорости } \Delta V_{\text{т}} = 1 - \sqrt{\frac{2 \cdot (\tilde{r} - 1)}{(\tilde{r} \cdot \sec \Theta_{\text{вх}})^2 - 1}},$$

где  $\tilde{r} = \frac{r_c}{r_{\text{ат}}}$ ;

$$v_{\text{т}} = \begin{cases} \arccos b_{\text{в}}, & \text{при } |b_{\text{в}}| \leq 1 \\ 0, & \text{при } |b_{\text{в}}| > 1 \end{cases}, \quad (28)$$

$$\text{где } b_{\text{в}} = \frac{\Delta V_{\text{т}}^2 + 2(\tilde{r} - 1)}{\Delta V_{\text{т}}}.$$

2.4.4. Значения  $V_{\text{вх}}$  и  $\Theta_{\text{вх}}$  вычисляют по формулам:

$$V_{\text{вх}} = V_c \cdot \tilde{V}_{\text{вх}}, \quad (29)$$

$$\text{где } \tilde{V}_{\text{вх}} = \sqrt{(1 - \Delta V_{\text{т}})^2 + 2(\tilde{r} - 1)};$$

$$\Theta_{\text{вх}} = \arccos \frac{\tilde{r}(1 - \Delta V_{\text{т}})}{\sqrt{(1 - \Delta V_{\text{т}})^2 + 2(\tilde{r} - 1)}}. \quad (30)$$

2.4.5. Номинальные затраты характеристической скорости на спуск с круговой орбиты для угла входа  $\Theta_{\text{вх}}$  в диапазоне от минус 0,2 до минус 4,0 градуса в зависимости от высоты орбиты приведены в табл. 9—47. При расчете приняты следующие допущения:

торможение ИСЗ атмосферой при полете по эллиптической траектории отсутствует;

граница атмосферы соответствует высоте 100 км,  $r_{\text{ат}} = 6478,4$  км.

Таблица 3

## Затраты топлива за сутки (GC) и за виток (GB), кг

Высота, км	Затраты	Фиксированная уровень солнечной активности: $F_{10} \cdot 10^{-22}$ Вт(м <sup>2</sup> ·Гц)										
		65	75	100	125	150	175	200	225	250	275	
120	GC	6.46+02	6.46+02	6.46+02	6.46+02	6.46+02	6.46+02	6.46+02	6.46+02	6.46+02	6.46+02	6.46+02
120	GB	3.98+01	3.98+01	3.98+01	3.98+01	3.98+01	3.98+01	3.98+01	3.98+01	3.98+01	3.98+01	3.98+01
125	GC	3.37+02	3.38+02	3.49+02	3.45+02	3.45+02	3.45+02	3.53+02	3.54+02	3.56+02	3.57+02	3.57+02
125	GB	2.08+01	2.08+01	2.15+01	2.12+01	2.12+01	2.13+01	2.17+01	2.18+01	2.19+01	2.20+01	2.20+01
130	GC	2.05+02	2.07+02	2.17+02	2.17+02	2.19+02	2.21+02	2.27+02	2.29+02	2.31+02	2.33+02	2.33+02
130	GB	1.27+01	1.28+01	1.34+01	1.34+01	1.35+01	1.36+01	1.40+01	1.41+01	1.43+01	1.44+01	1.44+01
135	GC	1.35+02	1.37+02	1.45+02	1.47+02	1.50+02	1.53+02	1.57+02	1.59+02	1.62+02	1.64+02	1.64+02
135	GB	8.35+00	8.48+00	8.94+00	9.10+00	9.28+00	9.44+00	9.70+00	9.84+00	1.00+01	1.01+01	1.01+01
140	GC	9.37+01	9.57+01	1.01+02	1.05+02	1.08+02	1.11+02	1.14+02	1.16+02	1.19+02	1.21+02	1.21+02
140	GB	5.79+00	5.91+00	6.27+00	6.50+00	6.70+00	6.85+00	7.05+00	7.20+00	7.35+00	7.45+00	7.45+00
145	GC	6.72+01	6.91+01	7.34+01	7.76+01	8.07+01	8.32+01	8.56+01	8.78+01	9.00+01	9.16+01	9.16+01
145	GB	4.16+00	4.27+00	4.54+00	4.80+00	5.00+00	5.15+00	5.30+00	5.44+00	5.57+00	5.67+00	5.67+00
150	GC	4.95+01	5.12+01	5.45+01	5.88+01	6.17+01	6.39+01	6.58+01	6.79+01	6.98+01	7.13+01	7.13+01
150	GB	3.07+00	3.17+00	3.38+00	3.64+00	3.82+00	3.96+00	4.08+00	4.20+00	4.32+00	4.41+00	4.41+00
155	GC	3.73+01	3.87+01	4.14+01	4.54+01	4.83+01	5.01+01	5.15+01	5.34+01	5.51+01	5.64+01	5.64+01
155	GB	2.31+00	2.40+00	2.57+00	2.82+00	2.98+00	3.11+00	3.20+00	3.31+00	3.42+00	3.50+00	3.50+00
160	GC	2.85+01	2.98+01	3.19+01	3.56+01	3.82+01	3.98+01	4.10+01	4.27+01	4.42+01	4.54+01	4.54+01
160	GB	1.77+00	1.85+00	1.98+00	2.21+00	2.36+00	2.47+00	2.55+00	2.65+00	2.74+00	2.82+00	2.82+00
165	GC	2.22+01	2.33+01	2.49+01	2.83+01	3.05+01	3.21+01	3.30+01	3.45+01	3.58+01	3.69+01	3.69+01
165	GB	1.38+00	1.45+00	1.55+00	1.76+00	1.89+00	2.00+00	2.05+00	2.15+00	2.23+00	2.30+00	2.30+00
170	GC	1.75+01	1.84+01	1.97+01	2.28+01	2.47+01	2.62+01	2.69+01	2.82+01	2.94+01	3.04+01	3.04+01
170	GB	1.09+00	1.15+00	1.23+00	1.42+00	1.54+00	1.63+00	1.67+00	1.76+00	1.83+00	1.89+00	1.89+00
175	GC	1.39+01	1.47+01	1.58+01	1.85+01	2.02+01	2.15+01	2.21+01	2.33+01	2.43+01	2.52+01	2.52+01
175	GB	8.66+01	9.16+01	9.82+01	1.15+02	1.26+02	1.34+02	1.38+02	1.45+02	1.51+02	1.57+02	1.57+02
180	GC	1.01+01	1.10+01	1.22+01	1.48+01	1.66+01	1.78+01	1.87+01	2.00+01	2.08+01	2.16+01	2.16+01
180	GB	6.29+01	6.85+01	7.63+01	9.24+01	1.04+02	1.11+02	1.17+02	1.24+02	1.29+02	1.35+02	1.35+02
185	GC	8.38+00	9.11+00	1.03+01	1.25+01	1.40+01	1.51+01	1.59+01	1.70+01	1.77+01	1.85+01	1.85+01
185	GB	5.23+01	5.69+01	6.40+01	7.83+01	8.75+01	9.42+01	9.95+01	1.05+02	1.10+02	1.15+02	1.15+02
190	GC	6.98+00	7.59+00	8.64+00	1.07+01	1.19+01	1.29+01	1.36+01	1.46+01	1.52+01	1.59+01	1.59+01
190	GB	4.37+01	4.75+01	5.40+01	6.67+01	7.44+01	8.05+01	8.52+01	9.12+01	9.50+01	9.94+01	9.94+01
195	GC	5.84+00	6.35+00	7.31+00	9.10+00	1.02+01	1.11+01	1.17+01	1.25+01	1.31+01	1.38+01	1.38+01
195	GB	3.66+01	3.98+01	4.58+01	5.70+01	6.36+01	6.92+01	7.33+01	7.89+01	8.22+01	8.63+01	8.63+01
200	GC	4.91+00	5.34+00	6.21+00	7.80+00	8.71+00	9.54+00	1.01+01	1.03+01	1.10+01	1.20+01	1.20+01
200	GB	3.08+01	3.35+01	3.89+01	4.83+01	5.46+01	5.98+01	6.34+01	6.85+01	7.15+01	7.53+01	7.53+01
205	GC	4.14+00	4.51+00	5.29+00	6.71+00	7.50+00	8.26+00	8.79+00	9.52+00	9.97+00	1.05+01	1.05+01
205	GB	2.59+01	2.83+01	3.32+01	4.21+01	4.70+01	5.18+01	5.51+01	5.98+01	6.26+01	6.61+01	6.61+01
210	GC	3.50+00	3.82+00	4.53+00	5.79+00	6.48+00	7.18+00	7.63+00	8.34+00	8.75+00	9.28+00	9.28+00
210	GB	2.20+01	2.40+01	2.85+01	3.64+01	4.07+01	4.51+01	4.81+01	5.24+01	5.50+01	5.83+01	5.83+01
215	GC	2.96+00	3.24+00	3.89+00	5.01+00	5.62+00	6.26+00	6.71+00	7.33+00	7.72+00	8.21+00	8.21+00
215	GB	1.85+01	2.04+01	2.44+01	3.15+01	3.54+01	3.94+01	4.22+01	4.61+01	4.85+01	5.16+01	5.16+01
220	GC	2.52+00	2.77+00	3.35+00	4.35+00	4.89+00	5.48+00	5.83+00	6.46+00	6.83+00	7.29+00	7.29+00
220	GB	1.59+01	1.74+01	2.11+01	2.74+01	3.08+01	3.45+01	3.71+01	4.07+01	4.30+01	4.59+01	4.59+01
225	GC	2.15+00	2.37+00	2.89+00	3.78+00	4.27+00	4.81+00	5.19+00	5.72+00	6.03+00	6.49+00	6.49+00
225	GB	1.35+01	1.49+01	1.82+01	2.38+01	2.69+01	3.03+01	3.27+01	3.60+01	3.82+01	4.09+01	4.09+01
230	GC	1.84+00	2.03+00	2.50+00	3.30+00	3.74+00	4.24+00	4.59+00	5.07+00	5.40+00	5.89+00	5.89+00
230	GB	1.16+01	1.28+01	1.58+01	2.08+01	2.35+01	2.68+01	2.89+01	3.20+01	3.41+01	3.65+01	3.65+01
235	GC	1.57+00	1.75+00	2.17+00	2.83+00	3.28+00	3.74+00	4.07+00	4.52+00	4.82+00	5.20+00	5.20+00
235	GB	9.93+02	1.10+01	1.37+01	1.82+01	2.07+01	2.35+01	2.57+01	2.85+01	3.05+01	3.28+01	3.28+01
240	GC	1.35+00	1.50+00	1.89+00	2.53+00	2.89+00	3.31+00	3.61+00	4.03+00	4.32+00	4.67+00	4.67+00
240	GB	8.54+02	9.52+02	1.20+01	1.60+01	1.83+01	2.10+01	2.29+01	2.55+01	2.73+01	2.95+01	2.95+01
245	GC	1.16+00	1.30+00	1.65+00	2.22+00	2.55+00	2.94+00	3.22+00	3.61+00	3.88+00	4.21+00	4.21+00
245	GB	7.33+02	8.23+02	1.04+01	1.41+01	1.62+01	1.85+01	2.04+01	2.28+01	2.46+01	2.67+01	2.67+01
250	GC	1.00+00	1.13+00	1.44+00	1.96+00	2.26+00	2.61+00	2.87+00	3.23+00	3.49+00	3.80+00	3.80+00
250	GB	6.35+02	7.14+02	9.13+02	1.24+01	1.43+01	1.66+01	1.82+01	2.05+01	2.21+01	2.41+01	2.41+01
255	GC	8.68+01	9.78+01	1.26+02	1.73+02	2.00+02	2.33+02	2.57+02	2.91+02	3.15+02	3.44+02	3.44+02
255	GB	5.50+02	6.21+02	8.01+02	1.10+01	1.27+01	1.48+01	1.63+01	1.84+01	2.00+01	2.18+01	2.18+01
260	GC	7.50+01	8.51+01	1.11+02	1.53+02	1.78+02	2.08+02	2.31+02	2.62+02	2.85+02	3.12+02	3.12+02
260	GB	4.77+02	5.41+02	7.03+02	9.70+02	1.13+01	1.32+01	1.47+01	1.66+01	1.81+01	1.98+01	1.98+01
265	GC	6.51+01	7.42+01	9.74+01	1.35+02	1.58+02	1.85+02	2.07+02	2.35+02	2.58+02	2.84+02	2.84+02
265	GB	4.14+02	4.72+02	6.19+02	8.60+02	1.01+01	1.18+01	1.32+01	1.50+01	1.64+01	1.80+01	1.80+01
270	GC	5.63+01	6.48+01	8.58+01	1.20+02	1.41+02	1.67+02	1.87+02	2.13+02	2.34+02	2.58+02	2.58+02
270	GB	3.60+02	4.13+02	5.46+02	7.64+02	8.97+02	1.05+01	1.19+01	1.36+01	1.49+01	1.64+01	1.64+01



Высота, км	Затраты	Фиксированный уровень солнечной активности $F_{10} \cdot 10^{-22}$ Вт/(м <sup>2</sup> ·Гц)									
		65	75	100	125	150	175	200	225	250	275
275	GC	4.92-01	5.67-01	7.57-01	1.07+00	1.26+00	1.50+00	1.68+00	1.93+00	2.13+00	2.35+00
275	GB	3.14-02	3.62-02	4.82-02	6.79-02	8.02-02	9.55-02	1.07-01	1.23-01	1.36-01	1.50-01
280	GC	4.29-01	4.97-01	6.69-01	9.48-01	1.13+00	1.35+00	1.52+00	1.75+00	1.94+00	2.15+00
280	GB	2.74-02	3.17-02	4.27-02	6.05-02	7.19-02	8.59-02	9.70-02	1.12-01	1.24-01	1.37-01
285	GC	3.75-01	4.37-01	5.92-01	8.45-01	1.01+00	1.21+00	1.38+00	1.59+00	1.77+00	1.97+00
285	GB	2.40-02	2.79-02	3.78-02	5.40-02	6.45-02	7.75-02	8.79-02	1.02-01	1.13-01	1.25-01
290	GC	3.28-01	3.84-01	5.25-01	7.54-01	9.06-01	1.09+00	1.25+00	1.45+00	1.62+00	1.80+00
290	GB	2.10-02	2.46-02	3.36-02	4.82-02	5.79-02	7.00-02	7.97-02	9.25-02	1.03-01	1.15-01
295	GC	2.88-01	3.39-01	4.66-01	6.74-01	8.14-01	9.88-01	1.13+00	1.32+00	1.48+00	1.65+00
295	GB	1.84-02	2.17-02	2.99-02	4.32-02	5.21-02	6.33-02	7.24-02	8.44-02	9.47-02	1.06-01
300	GC	2.52-01	2.99-01	4.15-01	6.03-01	7.33-01	8.94-01	1.03+00	1.20+00	1.35+00	1.52+00
300	GB	1.62-02	1.92-02	2.66-02	3.87-02	4.70-02	5.73-02	6.59-02	7.71-02	8.68-02	9.73-02
310	GC	1.95-01	2.34-01	3.29-01	4.85-01	5.96-01	7.34-01	8.52-01	1.00+00	1.14+00	1.29+00
310	GB	1.25-02	1.50-02	2.12-02	3.12-02	3.83-02	4.72-02	5.47-02	6.45-02	7.33-02	8.26-02
320	GC	1.52-01	1.84-01	2.63-01	3.92-01	4.87-01	6.06-01	7.09-01	8.43-01	9.65-01	1.09+00
320	GB	9.76-03	1.18-02	1.69-02	2.53-02	3.14-02	3.90-02	4.57-02	5.43-02	6.21-02	7.05-02
330	GC	1.18-01	1.45-01	2.11-01	3.18-01	4.00-01	5.03-01	5.94-01	7.11-01	8.20-01	9.36-01
330	GB	7.64-03	9.37-03	1.36-02	2.06-02	2.58-02	3.25-02	3.83-02	4.59-02	5.29-02	6.04-02
340	GC	9.29-02	1.15-01	1.70-01	2.60-01	3.30-01	4.19-01	4.99-01	6.02-01	7.00-01	8.03-01
340	GB	6.01-03	7.46-03	1.10-02	1.68-02	2.14-02	2.71-02	3.23-02	3.89-02	4.53-02	5.19-02
350	GC	7.33-02	9.21-02	1.38-01	2.13-01	2.74-01	3.50-01	4.21-01	5.11-01	6.00-01	6.91-01
350	GB	4.75-03	5.97-03	8.92-03	1.38-02	1.78-02	2.27-02	2.73-02	3.32-02	3.89-02	4.48-02
360	GC	5.80-02	7.38-02	1.12-01	1.75-01	2.28-01	2.94-01	3.56-01	4.36-01	5.15-01	5.97-01
360	GB	3.77-03	4.79-03	7.26-03	1.14-02	1.48-02	1.91-02	2.32-02	2.83-02	3.35-02	3.88-02
370	GC	4.61-02	5.93-02	9.12-02	1.44-01	1.90-01	2.47-01	3.03-01	3.73-01	4.45-01	5.18-01
370	GB	3.00-03	3.85-03	5.94-03	9.38-03	1.24-02	1.61-02	1.97-02	2.43-02	2.89-02	3.37-02
380	GC	3.68-02	4.79-02	7.46-02	1.19-01	1.59-01	2.09-01	2.58-01	3.20-01	3.85-01	4.60-01
380	GB	2.40-03	3.13-03	4.87-03	7.78-03	1.04-02	1.36-02	1.68-02	2.09-02	2.51-02	2.94-02
390	GC	2.94-02	3.89-02	6.13-02	9.90-02	1.34-01	1.77-01	2.21-01	2.76-01	3.34-01	3.93-01
390	GB	1.93-03	2.54-03	4.01-03	6.48-03	8.75-03	1.16-02	1.44-02	1.80-02	2.18-02	2.57-02
400	GC	2.37-02	3.16-02	5.05-02	8.25-02	1.13-01	1.51-01	1.89-01	2.38-01	2.90-01	3.43-01
400	GB	1.55-03	2.07-03	3.31-03	5.41-03	7.40-03	9.88-03	1.24-02	1.56-02	1.90-02	2.25-02
410	GC	1.91-02	2.58-02	4.18-02	6.89-02	9.54-02	1.28-01	1.63-01	2.06-01	2.53-01	3.01-01
410	GB	1.25-03	1.69-03	2.74-03	4.53-03	6.27-03	8.44-03	1.07-02	1.35-02	1.66-02	1.98-02
420	GC	1.54-02	2.11-02	3.46-02	5.77-02	8.08-02	1.10-01	1.40-01	1.79-01	2.21-01	2.64-01
420	GB	1.01-03	1.39-03	2.28-03	3.80-03	5.32-03	7.23-03	9.23-03	1.18-02	1.46-02	1.74-02
430	GC	1.25-02	1.73-02	2.88-02	4.85-02	6.87-02	9.41-02	1.21-01	1.55-01	1.94-01	2.33-01
430	GB	8.25-04	1.14-03	1.90-03	3.20-03	4.53-03	6.21-03	8.00-03	1.03-02	1.28-02	1.54-02
440	GC	1.02-02	1.43-02	2.40-02	4.08-02	5.85-02	8.08-02	1.05-01	1.36-01	1.70-01	2.05-01
440	GB	6.72-04	9.44-04	1.59-03	2.70-03	3.87-03	5.34-03	6.94-03	8.96-03	1.13-02	1.36-02
450	GC	8.29-03	1.18-02	2.01-02	3.44-02	5.00-02	6.96-02	9.11-02	1.18-01	1.50-01	1.82-01
450	GB	5.50-04	7.81-04	1.33-03	2.28-03	3.31-03	4.61-03	6.04-03	7.85-03	9.94-03	1.20-02
460	GC	6.78-03	9.76-03	1.68-02	2.91-02	4.28-02	6.00-02	7.93-02	1.04-01	1.32-01	1.61-01
460	GB	4.50-04	6.48-04	1.12-03	1.93-03	2.84-03	3.99-03	5.26-03	6.89-03	8.78-03	1.07-02
470	GC	5.56-03	8.10-03	1.41-02	2.47-02	3.67-02	5.19-02	6.91-02	9.09-02	1.17-01	1.43-01
470	GB	3.70-04	5.39-04	9.40-04	1.64-03	2.45-03	3.45-03	4.60-03	6.05-03	7.77-03	9.50-03
480	GC	4.57-03	6.74-03	1.19-02	2.10-02	3.16-02	4.50-02	6.03-02	7.99-02	1.03-01	1.27-01
480	GB	3.05-04	4.49-04	7.93-04	1.40-03	2.11-03	3.00-03	4.03-03	5.33-03	6.90-03	8.47-03
490	GC	3.76-03	5.62-03	1.00-02	1.79-02	2.72-02	3.90-02	5.28-02	7.04-02	9.16-02	1.13-01
490	GB	2.52-04	3.76-04	6.70-04	1.19-03	1.82-03	2.61-03	3.53-03	4.70-03	6.13-03	7.56-03
500	GC	3.11-03	4.70-03	8.47-03	1.52-02	2.35-02	3.39-02	4.63-02	6.20-02	8.14-02	1.01-01
500	GB	2.08-04	3.15-04	5.68-04	1.02-03	1.57-03	2.27-03	3.10-03	4.16-03	5.45-03	6.76-03
510	GC	2.57-03	3.93-03	7.18-03	1.30-02	2.03-02	2.96-02	4.06-02	5.48-02	7.24-02	9.01-02
510	GB	1.73-04	2.64-04	4.82-04	8.75-04	1.36-03	1.99-03	2.73-03	3.68-03	4.88-03	6.05-03
520	GC	2.13-03	3.30-03	6.09-03	1.12-02	1.76-02	2.58-02	3.57-02	4.85-02	6.45-02	8.06-02
520	GB	1.44-04	2.22-04	4.10-04	7.51-04	1.18-03	1.74-03	2.41-03	3.26-03	4.34-03	5.42-03
530	GC	1.77-03	2.78-03	5.18-03	9.57-03	1.53-02	2.26-02	3.15-02	4.30-02	5.75-02	7.22-02
530	GB	1.20-04	1.87-04	3.49-04	6.46-04	1.03-03	1.52-03	2.12-03	2.90-03	3.88-03	4.87-03
540	GC	1.48-03	2.34-03	4.41-03	8.23-03	1.33-02	1.97-02	2.78-02	3.81-02	5.14-02	6.48-02
540	GB	9.98-05	1.58-04	2.98-04	5.56-04	8.97-04	1.33-03	1.88-03	2.58-03	3.47-03	4.38-03
550	GC	1.23-03	1.97-03	3.77-03	7.08-03	1.16-02	1.73-02	2.45-02	3.39-02	4.60-02	5.82-02
550	GB	8.34-05	1.34-04	2.55-04	4.80-04	7.83-04	1.17-03	1.66-03	2.30-03	3.12-03	3.94-03
560	GC	1.03-03	1.67-03	3.22-03	6.11-03	1.01-02	1.52-02	2.17-02	3.02-02	4.12-02	5.23-02

Высота, км	Затраты	Фиксированный уровень солнечной активности $F_{10}^{-22}$ Вт/(м <sup>2</sup> ·Гн)									
		66	75	100	125	150	175	200	225	250	275
560	GB	6.99-05	1.13-04	2.19-04	4.15-04	6.84-04	1.03-03	1.47-03	2.05-03	2.80-03	3.55-03
570	GC	8.62-04	1.42-03	2.76-03	5.27-03	8.80-03	1.34-02	1.92-02	2.69-02	3.69-02	4.71-02
570	GB	5.86-05	9.63-05	1.88-04	3.59-04	5.99-04	9.10-04	1.31-03	1.83-03	2.51-03	3.21-03
580	GC	7.23-04	1.20-03	2.36-03	4.56-03	7.70-03	1.18-02	1.71-02	2.40-02	3.32-02	4.25-02
580	GB	4.93-05	8.19-05	1.61-04	3.11-04	5.25-04	8.03-04	1.16-03	1.63-03	2.26-03	2.90-03
590	GC	6.07-04	1.02-03	2.03-03	3.95-03	6.74-03	1.04-02	1.52-02	2.14-02	2.98-02	3.84-02
590	GB	4.15-05	6.98-05	1.39-04	2.70-04	4.61-04	7.09-04	1.04-03	1.46-03	2.04-03	2.62-03
600	GC	5.11-04	8.69-04	1.75-03	3.43-03	5.91-03	9.17-03	1.35-02	1.92-02	2.69-02	3.47-02
600	GB	3.50-05	5.95-05	1.20-04	2.35-04	4.05-04	6.28-04	9.24-04	1.31-03	1.84-03	2.37-03
610	GC	3.92-04	6.60-04	1.47-03	3.02-03	5.39-03	8.32-03	1.34-02	1.92-02	2.74-02	3.78-02
610	GB	2.69-05	4.53-05	1.01-04	2.07-04	3.70-04	5.71-04	9.18-04	1.31-03	1.88-03	2.60-03
620	GC	3.46-04	5.53-04	1.25-03	2.65-03	4.80-03	7.49-03	1.21-02	1.74-02	2.50-02	3.46-02
620	GB	2.38-05	3.80-05	8.61-05	1.82-04	3.30-04	5.15-04	8.31-04	1.20-03	1.72-03	2.38-03
630	GC	3.08-04	4.73-04	1.08-03	2.34-03	4.28-03	6.75-03	1.09-02	1.59-02	2.28-02	3.16-02
630	GB	2.12-05	3.26-05	7.46-05	1.61-04	2.95-04	4.65-04	7.53-04	1.09-03	1.57-03	2.18-03
640	GC	2.75-04	4.10-04	9.45-04	2.07-03	3.83-03	6.09-03	9.88-03	1.45-02	2.08-02	2.89-02
640	GB	1.90-05	2.84-05	6.53-05	1.43-04	2.65-04	4.20-04	6.83-04	9.99-04	1.44-03	1.99-03
650	GC	2.47-04	3.61-04	8.31-04	1.84-03	3.44-03	5.50-03	8.95-03	1.32-02	1.89-02	2.64-02
650	GB	1.71-05	2.50-05	5.75-05	1.27-04	2.38-04	3.81-04	6.19-04	9.13-04	1.31-03	1.83-03
660	GC	2.24-04	3.19-04	7.36-04	1.64-03	3.09-03	4.98-03	8.11-03	1.20-02	1.73-02	2.41-02
660	GB	1.55-05	2.22-05	5.11-05	1.14-04	2.14-04	3.45-04	5.62-04	8.34-04	1.20-03	1.67-03
670	GC	2.03-04	2.85-04	6.56-04	1.47-03	2.78-03	4.51-03	7.35-03	1.10-02	1.58-02	2.21-02
670	GB	1.41-05	1.98-05	4.56-05	1.02-04	1.93-04	3.13-04	5.11-04	7.62-04	1.10-03	1.54-03
680	GC	1.85-04	2.56-04	5.87-04	1.32-03	2.50-03	4.09-03	6.67-03	1.00-02	1.44-02	2.02-02
680	GB	1.29-05	1.78-05	4.09-05	9.18-05	1.74-04	2.85-04	4.64-04	6.96-04	1.00-03	1.41-03
690	GC	1.69-04	2.31-04	5.28-04	1.19-03	2.26-03	3.71-03	6.05-03	9.12-03	1.31-02	1.85-02
690	GB	1.18-05	1.61-05	3.68-05	8.27-05	1.58-04	2.59-04	4.22-04	6.37-04	9.17-04	1.29-03
700	GC	1.54-04	2.10-04	4.76-04	1.07-03	2.04-03	3.37-03	5.49-03	8.33-03	1.20-02	1.69-02
700	GB	1.08-05	1.47-05	3.33-05	7.48-05	1.43-04	2.36-04	3.84-04	5.83-04	8.39-04	1.18-03
710	GC	1.42-04	1.91-04	4.31-04	9.66-04	1.85-03	3.07-03	4.99-03	7.60-03	1.10-02	1.55-02
710	GB	9.94-06	1.34-05	3.02-05	6.78-05	1.30-04	2.15-04	3.50-04	5.33-04	7.68-04	1.08-03
720	GC	1.31-04	1.75-04	3.92-04	8.78-04	1.68-03	2.79-03	4.54-03	6.94-03	1.00-02	1.42-02
720	GB	9.17-06	1.23-05	2.75-05	6.15-05	1.18-04	1.96-04	3.19-04	4.88-04	7.03-04	9.95-04
730	GC	1.20-04	1.60-04	3.57-04	7.95-04	1.52-03	2.55-03	4.13-03	6.34-03	9.15-03	1.30-02
730	GB	8.48-06	1.13-05	2.51-05	5.60-05	1.07-04	1.79-04	2.91-04	4.47-04	6.44-04	9.13-04
740	GC	1.11-04	1.47-04	3.26-04	7.23-04	1.39-03	2.32-03	3.76-03	5.80-03	8.36-03	1.19-02
740	GB	7.85-06	1.04-05	2.30-05	5.10-05	9.77-05	1.64-04	2.65-04	4.09-04	5.90-04	8.38-04
750	GC	1.03-04	1.36-04	2.99-04	6.59-04	1.26-03	2.12-03	3.42-03	5.30-03	7.64-03	1.09-02
750	GB	7.29-06	9.58-06	2.11-05	4.66-05	8.91-05	1.50-04	2.42-04	3.75-04	5.40-04	7.69-04
760	GC	9.57-05	1.25-04	2.74-04	6.02-04	1.15-03	1.94-03	3.12-03	4.85-03	6.99-03	9.96-03
760	GB	6.78-06	8.87-06	1.94-05	4.26-05	8.14-05	1.37-04	2.21-04	3.43-04	4.95-04	7.06-04
770	GC	8.89-05	1.16-04	2.52-04	5.50-04	1.05-03	1.77-03	2.84-03	4.43-03	6.39-03	9.12-03
770	GB	6.31-06	8.23-06	1.79-05	3.91-05	7.45-05	1.26-04	2.02-04	3.15-04	4.54-04	6.48-04
780	GC	8.28-05	1.08-04	2.32-04	5.04-04	9.58-04	1.62-03	2.59-03	4.06-03	5.85-03	8.36-03
780	GB	5.89-06	7.65-06	1.65-05	3.59-05	6.82-05	1.15-04	1.84-04	2.89-04	4.16-04	5.95-04
790	GC	7.72-05	9.99-05	2.14-04	4.62-04	8.76-04	1.49-03	2.36-03	3.71-03	5.35-03	7.66-03
790	GB	5.50-06	7.12-06	1.53-05	3.30-05	6.25-05	1.05-04	1.69-04	2.65-04	3.81-04	5.46-04
800	GC	7.20-05	9.30-05	1.98-04	4.24-04	8.02-04	1.35-03	2.16-03	3.40-03	4.90-03	7.02-03
800	GB	5.15-06	6.64-06	1.42-05	3.03-05	5.73-05	9.74-05	1.54-04	2.43-04	3.50-04	5.02-04
810	GC	6.73-05	8.67-05	1.84-04	3.90-04	7.35-04	1.25-03	1.97-03	3.11-03	4.48-03	6.43-03
810	GB	4.82-06	6.21-06	1.31-05	2.79-05	5.26-05	8.96-05	1.41-04	2.23-04	3.21-04	4.61-04
820	GC	6.30-05	8.10-05	1.70-04	3.59-04	6.74-04	1.15-03	1.80-03	2.85-03	4.11-03	5.90-03
820	GB	4.52-06	5.81-06	1.22-05	2.58-05	4.84-05	8.24-05	1.29-04	2.05-04	2.95-04	4.23-04
830	GC	5.90-05	7.57-05	1.58-04	3.31-04	6.19-04	1.06-03	1.65-03	2.61-03	3.76-03	5.41-03
830	GB	4.24-06	5.44-06	1.14-05	2.38-05	4.45-05	7.59-05	1.18-04	1.88-04	2.70-04	3.89-04
840	GC	5.53-05	7.09-05	1.47-04	3.06-04	5.69-04	9.71-04	1.51-03	2.40-03	3.44-03	4.96-03
840	GB	3.99-06	5.11-06	1.06-05	2.20-05	4.10-05	7.00-05	1.09-04	1.73-04	2.48-04	3.57-04
850	GC	5.20-05	6.64-05	1.37-04	2.83-04	5.23-04	8.94-04	1.38-03	2.20-03	3.16-03	4.55-03
850	GB	3.75-06	4.80-06	9.89-06	2.04-05	3.78-05	6.45-04	9.95-05	1.59-04	2.28-04	3.28-04
860	GC	4.88-05	6.23-05	1.28-04	2.61-04	4.82-04	8.23-04	1.26-03	2.01-03	2.89-03	4.17-03
860	GB	3.53-06	4.51-06	9.23-06	1.89-05	3.49-05	5.95-05	9.13-05	1.46-04	2.09-04	3.02-04
870	GC	4.59-05	5.86-05	1.19-04	2.42-04	4.44-04	7.58-04	1.16-03	1.85-03	2.65-03	3.83-03

Высота, км	Затраты	Фиксированный уровень солнечной активности $F_{10} \cdot 10^{-22} \text{ В}^2/\text{м}^2(\text{ГГ})$									
		65	75	100	125	150	175	200	225	250	275
870	GB	3.33-05	4.25-06	8.64-05	1.75-05	3.22-05	5.50-05	8.38-05	1.34-04	1.92-04	2.78-04
880	GC	4.32-05	5.51-05	1.11-04	2.24-04	4.03-04	6.99-04	1.05-03	1.69-03	2.43-03	3.51-03
880	GB	3.14-06	4.00-06	8.09-05	1.63-05	2.97-05	5.08-05	7.70-05	1.23-04	1.77-04	2.55-04
890	GC	4.07-05	5.19-05	1.04-04	2.08-04	3.78-04	6.45-04	9.71-04	1.55-03	2.23-03	3.22-03
890	GB	2.97-05	3.78-05	7.58-05	1.51-05	2.75-05	4.70-05	7.07-05	1.13-04	1.62-04	2.35-04
900	GC	3.81-05	4.83-05	9.75-05	1.93-04	3.49-04	5.95-04	8.91-04	1.43-03	2.05-03	2.95-03
900	GB	2.83-06	3.56-06	7.11-06	1.41-05	2.55-05	4.35-05	6.50-05	1.04-04	1.49-04	2.16-04
910	GC	3.63-05	4.61-05	9.13-05	1.79-04	3.23-04	5.50-04	8.17-04	1.31-03	1.88-03	2.72-03
910	GB	2.65-06	3.37-06	6.67-06	1.31-05	2.35-05	4.02-05	5.97-05	9.59-05	1.37-04	1.99-04
920	GC	3.43-05	4.35-05	8.55-05	1.67-04	2.98-04	5.03-04	7.50-04	1.20-03	1.72-03	2.49-03
920	GB	2.51-06	3.19-06	6.27-06	1.22-05	2.18-05	3.73-05	5.49-05	8.82-05	1.26-04	1.83-04
930	GC	3.24-05	4.11-05	8.04-05	1.55-04	2.76-04	4.70-04	6.89-04	1.11-03	1.58-03	2.29-03
930	GB	2.38-06	3.02-06	5.90-06	1.14-05	2.03-05	3.45-05	5.05-05	8.12-05	1.16-04	1.68-04
940	GC	3.03-05	3.83-05	7.55-05	1.45-04	2.53-04	4.35-04	6.32-04	1.02-03	1.45-03	2.10-03
940	GB	2.25-06	2.85-06	5.55-06	1.05-05	1.88-05	3.20-05	4.65-05	7.48-05	1.07-04	1.55-04
950	GC	2.90-05	3.68-05	7.10-05	1.35-04	2.37-04	4.03-04	5.81-04	9.35-04	1.33-03	1.93-03
950	GB	2.14-06	2.71-06	5.23-06	9.95-06	1.75-05	2.97-05	4.28-05	6.83-05	9.82-05	1.42-04
960	GC	2.75-05	3.48-05	6.68-05	1.26-04	2.20-04	3.73-04	5.34-04	8.60-04	1.22-03	1.78-03
960	GB	2.03-06	2.57-06	4.93-06	9.30-06	1.62-05	2.78-05	3.95-05	6.35-05	9.04-05	1.31-04
970	GC	2.60-05	3.30-05	6.29-05	1.18-04	2.04-04	3.46-04	4.91-04	7.90-04	1.12-03	1.63-03
970	GB	1.93-06	2.44-06	4.66-06	8.70-06	1.51-05	2.56-05	3.64-05	5.85-05	8.32-05	1.21-04
980	GC	2.47-05	3.13-05	5.93-05	1.10-04	1.89-04	3.21-04	4.52-04	7.27-04	1.03-03	1.50-03
980	GB	1.83-06	2.32-06	4.40-06	8.14-06	1.40-05	2.38-05	3.35-05	5.39-05	7.66-05	1.11-04
990	GC	2.34-05	2.97-05	5.59-05	1.03-04	1.76-04	2.98-04	4.16-04	6.69-04	9.50-04	1.38-03
990	GB	1.74-06	2.21-06	4.15-06	7.63-06	1.31-05	2.21-05	3.03-05	4.67-05	7.05-05	1.02-04
1000	GC	2.22-05	2.82-05	5.27-05	9.61-05	1.63-04	2.76-04	3.83-04	6.16-04	8.73-04	1.27-03
1000	GB	1.65-06	2.10-06	3.93-06	7.15-06	1.22-05	2.05-05	2.85-05	4.58-05	6.50-05	9.43-05
1010	GC	2.11-05	2.68-05	4.98-05	8.99-05	1.52-04	2.57-04	3.53-04	5.67-04	8.02-04	1.16-03
1010	GB	1.57-06	2.00-06	3.72-06	6.71-06	1.13-05	1.92-05	2.63-05	4.23-05	5.99-05	8.69-05
1020	GC	2.01-05	2.55-05	4.71-05	8.42-05	1.42-04	2.38-04	3.25-04	5.22-04	7.38-04	1.07-03
1020	GB	1.50-06	1.90-06	3.52-06	6.30-06	1.05-05	1.78-05	2.43-05	3.90-05	5.52-05	8.00-05
1030	GC	1.91-05	2.42-05	4.45-05	7.89-05	1.32-04	2.22-04	3.00-04	4.81-04	6.79-04	9.84-04
1030	GB	1.43-06	1.81-06	3.33-06	5.91-06	9.87-06	1.66-05	2.24-05	3.60-05	5.08-05	7.37-05
1040	GC	1.81-05	2.30-05	4.21-05	7.40-05	1.23-04	2.06-04	2.76-04	4.43-04	6.24-04	9.05-04
1040	GB	1.35-06	1.73-06	3.16-06	5.56-06	9.21-06	1.55-05	2.07-05	3.32-05	4.69-05	6.80-05
1050	GC	1.73-05	2.19-05	3.98-05	6.95-05	1.14-04	1.92-04	2.55-04	4.08-04	5.74-04	8.33-04
1050	GB	1.30-06	1.65-06	2.99-06	5.23-06	8.61-06	1.44-05	1.92-05	3.07-05	4.32-05	6.26-05
1060	GC	1.65-05	2.03-05	3.77-05	6.52-05	1.07-04	1.79-04	2.35-04	3.76-04	5.29-04	7.65-04
1060	GB	1.24-06	1.58-06	2.84-06	4.92-06	8.04-06	1.35-05	1.77-05	2.83-05	3.98-05	5.77-05
1070	GC	1.57-05	1.99-05	3.57-05	6.13-05	9.96-05	1.68-04	2.17-04	3.47-04	4.87-04	7.05-04
1070	GB	1.18-06	1.50-06	2.70-06	4.63-06	7.52-06	1.26-05	1.61-05	2.62-05	3.67-05	5.32-05
1080	GC	1.49-05	1.90-05	3.39-05	5.76-05	9.29-05	1.55-04	2.00-04	3.20-04	4.48-04	6.49-04
1080	GB	1.13-06	1.44-06	2.56-06	4.36-06	7.03-06	1.17-05	1.52-05	2.42-05	3.39-05	4.91-05
1090	GC	1.42-05	1.81-05	3.21-05	5.41-05	8.68-05	1.44-04	1.85-04	2.95-04	4.12-04	5.97-04
1090	GB	1.08-06	1.37-06	2.43-06	4.11-06	6.58-06	1.09-05	1.40-05	2.23-05	3.13-05	4.53-05
1100	GC	1.36-05	1.73-05	3.05-05	5.09-05	8.11-05	1.35-04	1.71-04	2.72-04	3.83-04	5.49-04
1100	GB	1.03-06	1.31-06	2.31-06	3.87-06	6.16-06	1.02-05	1.30-05	2.07-05	2.83-05	4.17-05
1110	GC	1.30-05	1.65-05	2.83-05	4.79-05	7.58-05	1.26-04	1.58-04	2.51-04	3.60-04	5.06-04
1110	GB	9.87-07	1.26-05	2.20-06	3.65-06	5.77-06	9.56-06	1.20-05	1.91-05	2.63-05	3.85-05
1120	GC	1.24-05	1.58-05	2.75-05	4.51-05	7.09-05	1.17-04	1.46-04	2.31-04	3.22-04	4.66-04
1120	GB	9.44-07	1.20-06	2.10-06	3.44-06	5.41-06	8.94-06	1.11-05	1.77-05	2.46-05	3.55-05
1130	GC	1.18-05	1.51-05	2.61-05	4.25-05	6.63-05	1.03-04	1.35-04	2.14-04	2.97-04	4.29-04
1130	GB	9.04-07	1.15-05	1.99-06	3.25-06	5.07-06	8.35-06	1.03-05	1.63-05	2.27-05	3.28-05
1140	GC	1.13-05	1.44-05	2.48-05	4.01-05	6.21-05	1.02-04	1.25-04	1.97-04	2.74-04	3.95-04
1140	GB	8.65-07	1.10-06	1.90-06	3.07-06	4.76-06	7.82-06	9.56-06	1.51-05	2.10-05	3.02-05
1150	GC	1.08-05	1.38-05	2.35-05	3.78-05	5.81-05	9.54-05	1.15-04	1.82-04	2.52-04	3.64-04
1150	GB	8.29-07	1.05-06	1.81-06	2.90-06	4.43-06	7.32-06	8.83-06	1.40-05	1.94-05	2.79-05
1160	GC	1.03-05	1.32-05	2.24-05	3.57-05	5.35-05	8.92-05	1.07-04	1.68-04	2.33-04	3.35-04
1160	GB	7.94-07	1.01-06	1.73-06	2.74-06	4.19-06	6.83-06	8.22-06	1.29-05	1.79-05	2.58-05
1170	GC	9.87-07	1.23-05	2.14-06	3.37-06	5.11-06	8.34-06	9.83-06	1.55-04	2.15-04	3.09-04
1170	GB	7.61-07	9.72-07	1.65-06	2.59-06	3.93-06	6.42-06	7.62-06	1.20-05	1.65-05	2.38-05
1180	GC	9.45-08	1.21-05	2.03-06	3.18-06	4.79-06	7.80-06	9.16-06	1.44-04	1.98-04	2.84-04



Высота, км	Затраты	Фиксированный уровень солнечной активности $F_{10}^{-22}$ Вт/(м <sup>2</sup> ·Гц)									
		65	75	100	125	150	175	200	225	250	275
1180	GB	7.29-07	9.32-07	1.57-06	2.45-05	3.70-05	6.02-03	7.07-06	1.11-05	1.53-05	2.20-05
1190	GC	9.04-06	1.16-05	1.91-05	3.03-05	4.49-05	7.29-05	8.49-05	1.33-04	1.83-04	2.62-04
1190	GB	6.99-07	8.95-07	1.50-06	2.32-06	3.47-06	5.64-06	6.57-06	1.03-05	1.41-05	2.03-05
1200	GC	8.66-06	1.11-05	1.85-05	2.84-05	4.21-05	6.83-05	7.87-05	1.23-04	1.68-04	2.42-04
1200	GB	6.71-07	8.59-07	1.43-06	2.20-06	3.26-06	5.29-06	6.10-06	9.51-06	1.31-05	1.87-05
1210	GC	8.29-03	1.06-05	1.76-05	2.68-05	3.95-05	6.39-05	7.29-05	1.13-04	1.55-04	2.23-04
1210	GB	6.44-07	8.25-07	1.37-06	2.08-06	3.07-06	4.96-06	5.66-06	8.81-06	1.21-05	1.73-05
1220	GC	7.99-03	1.02-05	1.68-05	2.54-05	3.71-05	5.99-05	6.76-05	1.05-04	1.43-04	2.05-04
1220	GB	6.18-07	7.92-07	1.31-06	1.97-06	2.89-06	4.65-06	5.26-06	8.16-06	1.12-05	1.60-05
1230	GC	7.61-06	9.77-06	1.60-06	2.40-06	3.49-06	5.61-06	6.27-06	9.70-06	1.32-04	1.89-04
1230	GB	5.93-07	7.61-07	1.25-06	1.87-06	2.72-06	4.37-06	4.89-06	7.57-06	1.03-05	1.48-05
1240	GC	7.30-06	9.37-06	1.53-06	2.27-06	3.28-06	5.25-06	5.81-06	8.98-06	1.22-04	1.75-04
1240	GB	5.70-07	7.32-07	1.19-06	1.77-06	2.56-06	4.10-06	4.54-06	7.01-06	9.55-06	1.36-05
1250	GC	7.00-06	8.99-06	1.46-06	2.15-06	3.08-06	4.93-06	5.40-06	8.31-06	1.13-04	1.61-04
1250	GB	5.48-07	7.04-07	1.14-06	1.68-06	2.41-06	3.85-06	4.22-06	6.50-06	8.83-06	1.26-06
1260	GC	6.71-03	8.63-06	1.39-06	2.03-06	2.90-06	4.62-06	5.01-06	7.69-06	1.04-04	1.48-04
1260	GB	5.26-07	6.77-07	1.09-06	1.60-06	2.27-06	3.62-06	3.93-06	6.03-06	8.18-06	1.16-06
1270	GC	6.44-06	8.29-06	1.33-06	1.93-06	2.72-06	4.33-06	4.65-06	7.12-06	9.63-06	1.37-04
1270	GB	5.05-07	6.51-07	1.04-06	1.51-06	2.14-06	3.40-06	3.65-06	5.59-06	7.57-06	1.08-05
1280	GC	6.18-06	7.96-06	1.27-06	1.83-06	2.53-06	4.07-06	4.32-06	6.59-06	8.90-06	1.26-04
1280	GB	4.87-07	6.27-07	1.00-06	1.44-06	2.02-06	3.20-06	3.40-06	5.19-06	7.00-06	9.95-06
1290	GC	5.93-03	7.65-06	1.21-06	1.73-06	2.41-06	3.82-06	4.01-06	6.10-06	8.22-06	1.17-04
1290	GB	4.68-07	6.03-07	9.57-07	1.37-06	1.90-06	3.01-06	3.16-06	4.81-06	6.48-06	9.20-06
1300	GC	5.70-06	7.35-06	1.16-06	1.64-06	2.27-06	3.58-06	3.73-06	5.65-06	7.60-06	1.08-04
1300	GB	4.50-07	5.81-07	9.17-07	1.30-06	1.83-06	2.83-06	2.95-06	4.47-06	6.00-06	8.50-06
1310	GC	5.47-06	7.05-06	1.11-06	1.55-06	2.14-06	3.35-06	3.46-06	5.23-06	7.02-06	9.93-06
1310	GB	4.33-07	5.59-07	8.79-07	1.23-06	1.69-06	2.65-06	2.74-06	4.15-06	5.56-06	7.83-06
1320	GC	5.26-06	6.79-06	1.06-06	1.48-06	2.02-06	3.16-06	3.22-06	4.83-06	6.49-06	9.16-06
1320	GB	4.17-07	5.39-07	8.42-07	1.17-06	1.60-06	2.51-06	2.55-06	3.85-06	5.15-06	7.27-06
1330	GC	5.05-06	6.53-06	1.02-06	1.40-06	1.90-06	2.97-06	2.99-06	4.49-06	6.00-06	8.46-06
1330	GB	4.02-07	5.19-07	8.07-07	1.12-06	1.51-06	2.36-06	2.38-06	3.57-06	4.77-06	6.73-06
1340	GC	4.85-06	6.28-06	9.72-06	1.33-06	1.79-06	2.79-06	2.78-06	4.17-06	5.55-06	7.81-06
1340	GB	3.87-07	5.01-07	7.74-07	1.06-06	1.43-06	2.22-06	2.22-06	3.32-06	4.42-06	6.22-06
1350	GC	4.67-06	6.05-06	9.30-06	1.26-06	1.69-06	2.62-06	2.59-06	3.85-06	5.13-06	7.21-06
1350	GB	3.73-07	4.83-07	7.43-07	1.01-06	1.35-06	2.03-06	2.07-06	3.08-06	4.10-06	5.76-06
1360	GC	4.49-03	5.82-06	8.91-06	1.30-06	1.59-06	2.47-06	2.41-06	3.58-06	4.75-06	6.69-06
1360	GB	3.59-07	4.65-07	7.12-07	9.61-07	1.27-06	1.97-06	1.93-06	2.85-06	3.83-06	5.33-06
1370	GC	4.32-03	5.63-06	8.53-06	1.14-06	1.50-06	2.32-06	2.24-06	3.32-06	4.39-06	6.15-06
1370	GB	3.46-07	4.49-07	6.84-07	9.15-07	1.20-06	1.85-06	1.80-06	2.65-06	3.52-06	4.93-06
1380	GC	4.15-06	5.39-06	8.18-06	1.09-06	1.42-06	2.18-06	2.09-06	3.08-06	4.05-06	5.68-06
1380	GB	3.33-07	4.33-07	6.56-07	8.71-07	1.14-06	1.75-06	1.68-06	2.47-06	3.26-06	4.56-06
1390	GC	4.00-06	5.20-06	7.84-06	1.03-06	1.34-06	2.06-06	1.94-06	2.83-06	3.76-06	5.25-06
1390	GB	3.21-07	4.18-07	6.30-07	8.30-07	1.03-06	1.65-06	1.56-06	2.30-06	3.03-06	4.22-06
1400	GC	3.85-06	5.01-06	7.51-06	9.81-06	1.26-06	1.94-06	1.81-06	2.65-06	3.48-06	4.85-06
1400	GB	3.10-07	4.03-07	6.05-07	7.91-07	1.02-06	1.56-06	1.45-06	2.14-06	2.81-06	3.91-06
1410	GC	3.70-03	4.82-06	7.20-06	9.34-06	1.19-06	1.82-06	1.69-06	2.46-06	3.22-06	4.48-06
1410	GB	2.99-07	3.89-07	5.82-07	7.54-07	9.65-07	1.47-06	1.36-06	1.99-06	2.60-06	3.62-06
1420	GC	3.57-03	4.65-06	6.91-06	8.88-06	1.13-06	1.72-06	1.57-06	2.28-06	2.98-06	4.14-06
1420	GB	2.88-07	3.76-07	5.59-07	7.19-07	9.13-07	1.39-06	1.27-06	1.85-06	2.41-06	3.35-06
1430	GC	3.43-06	4.48-06	6.63-06	8.46-06	1.07-06	1.62-06	1.46-06	2.12-06	2.76-06	3.83-06
1430	GB	2.78-07	3.63-07	5.37-07	6.85-07	8.65-07	1.31-06	1.19-06	1.72-06	2.24-06	3.10-06
1440	GC	3.31-06	4.32-06	6.36-06	8.05-06	1.01-06	1.52-06	1.37-06	1.97-06	2.56-06	3.54-06
1440	GB	2.69-07	3.51-07	5.16-07	6.54-07	8.19-07	1.24-06	1.11-06	1.60-06	2.08-06	2.87-06
1450	GC	3.19-03	4.17-06	6.10-06	7.67-06	9.54-06	1.44-06	1.27-06	1.83-06	2.37-06	3.27-06
1450	GB	2.59-07	3.39-07	4.96-07	6.24-07	7.76-07	1.17-06	1.04-06	1.49-06	1.93-06	2.66-06
1460	GC	3.07-03	4.02-06	5.83-06	7.30-06	9.02-06	1.35-06	1.19-06	1.70-06	2.20-06	3.02-06
1460	GB	2.50-07	3.28-07	4.77-07	5.95-07	7.35-07	1.10-06	9.68-07	1.38-06	1.79-06	2.46-06
1470	GC	2.96-06	3.88-06	5.62-06	6.96-06	8.53-06	1.28-06	1.11-06	1.58-06	2.04-06	2.80-06
1470	GB	2.42-07	3.17-07	4.59-07	5.68-07	6.97-07	1.04-06	9.05-07	1.29-06	1.66-06	2.28-06
1480	GC	2.85-06	3.74-06	5.40-06	6.63-06	8.08-06	1.21-06	1.03-06	1.47-06	1.89-06	2.59-06
1480	GB	2.34-07	3.03-07	4.42-07	5.43-07	6.61-07	9.87-07	8.46-07	1.20-06	1.54-06	2.12-06
1490	GC	2.75-03	3.61-06	5.19-06	6.32-06	7.64-06	1.14-06	9.65-06	1.36-06	1.75-06	2.39-06
1490	GB	2.26-07	2.96-07	4.25-07	5.18-07	6.27-07	9.33-07	7.91-07	1.12-06	1.43-06	1.95-06
1500	GC	2.65-06	3.49-06	4.98-06	6.03-06	7.24-06	1.07-06	9.00-06	1.27-06	1.62-06	2.21-06
1500	GB	2.18-07	2.83-07	4.09-07	4.95-07	5.95-07	8.82-07	7.40-07	1.04-06	1.33-06	1.82-06

Максимальные затраты топлива за сутки (GC) и за виток (GB), кг

Высота, км	Затраты	Фиксированный уровень солнечной активности $F_{10.7} \cdot 10^{-22}$ Вт/(м <sup>2</sup> ·Гц)											
		65	75	100	125	150	175	200	225	250	275		
120	GC	6.46+02	6.46+02	6.46+02	6.46+02	6.46+02	6.46+02	6.46+02	6.46+02	6.46+02	6.46+02	6.46+02	6.46+02
120	GB	3.98+01	3.98+01	3.98+01	3.98+01	3.98+01	3.98+01	3.98+01	3.98+01	3.98+01	3.98+01	3.98+01	3.98+01
125	GC	3.51+02	3.52+02	3.63+02	3.55+02	3.55+02	3.54+02	3.60+02	3.60+02	3.60+02	3.60+02	3.61+02	3.61+02
125	GB	2.16+01	2.17+01	2.24+01	2.19+01	2.18+01	2.18+01	2.21+01	2.22+01	2.22+01	2.22+01	2.22+01	2.22+01
130	GC	2.21+02	2.23+02	2.33+02	2.30+02	2.30+02	2.32+02	2.36+02	2.38+02	2.39+02	2.40+02	2.40+02	2.40+02
130	GB	1.36+01	1.38+01	1.43+01	1.42+01	1.42+01	1.43+01	1.46+01	1.47+01	1.47+01	1.48+01	1.48+01	1.48+01
135	GC	1.50+02	1.52+02	1.60+02	1.60+02	1.62+02	1.64+02	1.67+02	1.69+02	1.70+02	1.72+02	1.72+02	1.72+02
135	GB	9.26+00	9.40+00	9.86+00	9.91+00	9.99+00	1.02+01	1.03+01	1.05+01	1.05+01	1.05+01	1.03+01	1.03+01
140	GC	1.07+02	1.09+02	1.15+02	1.17+02	1.19+02	1.22+02	1.23+02	1.26+02	1.27+02	1.29+02	1.29+02	1.29+02
140	GB	6.58+00	6.72+00	7.08+00	7.24+00	7.36+00	7.53+00	7.63+00	7.78+00	7.87+00	7.97+00	7.97+00	7.97+00
145	GC	7.83+01	8.04+01	8.48+01	8.81+01	9.04+01	9.32+01	9.42+01	9.66+01	9.80+01	9.96+01	9.96+01	9.96+01
145	GB	4.81+00	4.97+00	5.25+00	5.47+00	5.60+00	5.76+00	5.83+00	5.98+00	6.05+00	6.17+00	6.17+00	6.17+00
150	GC	5.89+01	6.09+01	6.43+01	6.82+01	7.03+01	7.29+01	7.35+01	7.58+01	7.71+01	7.87+01	7.87+01	7.87+01
150	GB	3.65+00	3.77+00	3.98+00	4.23+00	4.36+00	4.52+00	4.55+00	4.70+00	4.78+00	4.88+00	4.88+00	4.88+00
155	GC	4.53+01	4.70+01	4.96+01	5.37+01	5.57+01	5.81+01	5.84+01	6.05+01	6.18+01	6.33+01	6.33+01	6.33+01
155	GB	2.81+00	2.92+00	3.08+00	3.33+00	3.45+00	3.60+00	3.62+00	3.76+00	3.83+00	3.93+00	3.93+00	3.93+00
160	GC	3.53+01	3.69+01	3.90+01	4.29+01	4.48+01	4.69+01	4.71+01	4.91+01	5.02+01	5.16+01	5.16+01	5.16+01
160	GB	2.19+00	2.29+00	2.42+00	2.66+00	2.78+00	2.91+00	2.93+00	3.05+00	3.12+00	3.20+00	3.20+00	3.20+00
165	GC	2.89+01	2.93+01	3.10+01	3.47+01	3.64+01	3.84+01	3.85+01	4.02+01	4.13+01	4.26+01	4.26+01	4.26+01
165	GB	1.74+00	1.82+00	1.93+00	2.16+00	2.27+00	2.39+00	2.39+00	2.50+00	2.57+00	2.63+00	2.63+00	2.63+00
170	GC	2.24+01	2.36+01	2.49+01	2.83+01	3.00+01	3.17+01	3.17+01	3.33+01	3.43+01	3.54+01	3.54+01	3.54+01
170	GB	1.39+00	1.47+00	1.55+00	1.76+00	1.87+00	1.97+00	1.97+00	2.07+00	2.14+00	2.21+00	2.21+00	2.21+00
175	GC	1.81+01	1.91+01	2.02+01	2.34+01	2.49+01	2.64+01	2.64+01	2.78+01	2.87+01	2.98+01	2.98+01	2.98+01
175	GB	1.13+00	1.19+00	1.26+00	1.46+00	1.55+00	1.65+00	1.64+00	1.73+00	1.79+00	1.85+00	1.85+00	1.85+00
180	GC	1.21+01	1.32+01	1.49+01	1.79+01	1.97+01	2.11+01	2.25+01	2.39+01	2.48+01	2.58+01	2.58+01	2.58+01
180	GB	0.75+00	0.82+00	0.92+00	1.12+00	1.23+00	1.32+00	1.40+00	1.49+00	1.55+00	1.61+00	1.61+00	1.61+00
185	GC	1.03+01	1.13+01	1.28+01	1.55+01	1.69+01	1.83+01	1.94+01	2.07+01	2.14+01	2.23+01	2.23+01	2.23+01
185	GB	0.65+00	0.70+00	0.79+00	0.99+00	1.06+00	1.14+00	1.21+00	1.29+00	1.34+00	1.40+00	1.40+00	1.40+00
190	GC	0.85+00	0.97+00	1.10+01	1.35+01	1.47+01	1.59+01	1.69+01	1.80+01	1.85+01	1.95+01	1.95+01	1.95+01
190	GB	0.53+00	0.60+00	0.69+00	0.84+00	0.91+00	0.99+00	1.06+00	1.13+00	1.16+00	1.22+00	1.22+00	1.22+00
195	GC	7.60+00	8.31+00	9.57+00	1.18+01	1.27+01	1.39+01	1.47+01	1.58+01	1.63+01	1.71+01	1.71+01	1.71+01
195	GB	4.76+01	5.20+01	5.99+01	7.37+01	7.98+01	8.70+01	9.23+01	9.91+01	1.02+02	1.07+02	1.07+02	1.07+02
200	GC	6.55+00	7.16+00	8.32+00	1.03+01	1.11+01	1.22+01	1.29+01	1.39+01	1.44+01	1.51+01	1.51+01	1.51+01
200	GB	4.10+01	4.49+01	5.21+01	6.46+01	6.97+01	7.65+01	8.11+01	8.74+01	9.01+01	9.49+01	9.49+01	9.49+01
205	GC	5.65+00	6.19+00	7.24+00	9.04+00	9.75+00	1.07+01	1.14+01	1.23+01	1.27+01	1.34+01	1.34+01	1.34+01
205	GB	3.54+01	3.88+01	4.54+01	5.67+01	6.12+01	6.74+01	7.15+01	7.74+01	7.98+01	8.43+01	8.43+01	8.43+01
210	GC	4.88+00	5.36+00	6.32+00	7.96+00	8.57+00	9.50+00	1.01+01	1.10+01	1.13+01	1.20+01	1.20+01	1.20+01
210	GB	3.07+01	3.37+01	3.97+01	5.00+01	5.38+01	5.97+01	6.33+01	6.88+01	7.11+01	7.53+01	7.53+01	7.53+01
215	GC	4.23+00	4.65+00	5.54+00	7.01+00	7.56+00	8.42+00	8.95+00	9.77+00	1.01+01	1.07+01	1.07+01	1.07+01
215	GB	2.66+01	2.93+01	3.48+01	4.41+01	4.75+01	5.30+01	5.63+01	6.14+01	6.35+01	6.76+01	6.76+01	6.76+01
220	GC	3.67+00	4.05+00	4.86+00	6.20+00	6.68+00	7.49+00	7.97+00	8.74+00	9.05+00	9.66+00	9.66+00	9.66+00
220	GB	2.31+01	2.55+01	3.06+01	3.90+01	4.21+01	4.72+01	5.02+01	5.50+01	5.70+01	6.08+01	6.08+01	6.08+01
225	GC	3.19+00	3.53+00	4.27+00	5.49+00	5.93+00	6.68+00	7.12+00	7.84+00	8.14+00	8.71+00	8.71+00	8.71+00
225	GB	2.01+01	2.22+01	2.69+01	3.46+01	3.74+01	4.21+01	4.48+01	4.94+01	5.13+01	5.49+01	5.49+01	5.49+01
230	GC	2.78+00	3.08+00	3.76+00	4.87+00	5.27+00	5.97+00	6.37+00	7.05+00	7.34+00	7.88+00	7.88+00	7.88+00
230	GB	1.76+01	1.95+01	2.37+01	3.07+01	3.32+01	3.77+01	4.02+01	4.45+01	4.63+01	4.97+01	4.97+01	4.97+01
235	GC	2.43+00	2.70+00	3.32+00	4.33+00	4.70+00	5.35+00	5.72+00	6.36+00	6.63+00	7.15+00	7.15+00	7.15+00
235	GB	1.53+01	1.71+01	2.10+01	2.73+01	2.97+01	3.38+01	3.61+01	4.02+01	4.19+01	4.51+01	4.51+01	4.51+01
240	GC	2.12+00	2.37+00	2.94+00	3.85+00	4.19+00	4.83+00	5.15+00	5.75+00	6.01+00	6.50+00	6.50+00	6.50+00
240	GB	1.34+01	1.50+01	1.86+01	2.44+01	2.65+01	3.04+01	3.26+01	3.63+01	3.80+01	4.11+01	4.11+01	4.11+01
245	GC	1.85+00	2.08+00	2.60+00	3.44+00	3.75+00	4.32+00	4.65+00	5.21+00	5.46+00	5.92+00	5.92+00	5.92+00
245	GB	1.18+01	1.32+01	1.65+01	2.18+01	2.38+01	2.74+01	2.94+01	3.30+01	3.46+01	3.75+01	3.75+01	3.75+01
250	GC	1.63+00	1.83+00	2.31+00	3.07+00	3.37+00	3.90+00	4.20+00	4.73+00	4.97+00	5.41+00	5.41+00	5.41+00
250	GB	1.03+01	1.16+01	1.46+01	1.95+01	2.13+01	2.47+01	2.66+01	3.00+01	3.15+01	3.43+01	3.43+01	3.43+01
255	GC	1.43+00	1.62+00	2.05+00	2.75+00	3.03+00	3.52+00	3.80+00	4.30+00	4.54+00	4.95+00	4.95+00	4.95+00
255	GB	9.09+02	1.03+01	1.30+01	1.74+01	1.92+01	2.23+01	2.41+01	2.73+01	2.88+01	3.14+01	3.14+01	3.14+01
260	GC	1.26+00	1.43+00	1.83+00	2.46+00	2.72+00	3.19+00	3.45+00	3.92+00	4.15+00	4.54+00	4.54+00	4.54+00
260	GB	8.00+02	9.07+02	1.16+01	1.57+01	1.73+01	2.02+01	2.19+01	2.49+01	2.64+01	2.89+01	2.89+01	2.89+01
265	GC	1.11+00	1.26+00	1.63+00	2.21+00	2.46+00	2.89+00	3.14+00	3.57+00	3.80+00	4.17+00	4.17+00	4.17+00
265	GB	7.05+02	8.04+02	1.04+01	1.41+01	1.56+01	1.84+01	2.00+01	2.27+01	2.42+01	2.65+01	2.65+01	2.65+01
270	GC	9.78+01	1.12+00	1.45+00	1.99+00	2.22+00	2.62+00	2.86+00	3.27+00	3.49+00	3.84+00	3.84+00	3.84+00
270	GB	6.23+02	7.13+02	9.26+02	1.27+01	1.41+01	1.67+01	1.82+01	2.08+01	2.22+01	2.45+01	2.45+01	2.45+01

Высоты, км	Затраты	Фиксированный уровень солнечной активности $F_{10} \cdot 10^{-22}$ Вт/(м <sup>2</sup> ·Гц)									
		65	75	100	125	150	175	200	225	250	275
275	GC	8.64-01	9.93-01	1.30+00	1.79+00	2.01+00	2.38+00	2.61+00	2.99+00	3.20+00	3.54+00
275	GB	5.50-02	6.33-02	8.29-02	1.14-01	1.28-01	1.52-01	1.66-01	1.91-01	2.01-01	2.26-01
280	GC	7.64-01	8.83-01	1.16+00	1.61+00	1.82+00	2.17+00	2.38+00	2.74+00	2.95+00	3.27+00
280	GB	4.87-02	5.63-02	7.43-02	1.03-01	1.16-01	1.39-01	1.52-01	1.75-01	1.88-01	2.09-01
285	GC	6.76-01	7.85-01	1.04+00	1.45+00	1.65+00	1.98+00	2.18+00	2.52+00	2.72+00	3.02+00
285	GB	4.32-02	5.02-02	6.67-02	9.29-02	1.05-01	1.27-01	1.39-01	1.61-01	1.74-01	1.93-01
290	GC	5.99-01	7.01-01	9.37-01	1.31+00	1.50+00	1.81+00	1.99+00	2.32+00	2.51+00	2.80+00
290	GB	3.83-02	4.47-02	5.99-02	8.40-02	9.58-02	1.16-01	1.26-01	1.48-01	1.60-01	1.79-01
295	GC	5.31-01	6.24-01	8.42-01	1.19+00	1.36+00	1.65+00	1.83+00	2.13+00	2.32+00	2.59+00
295	GB	3.40-02	4.00-02	5.39-02	7.61-02	8.73-02	1.06-01	1.17-01	1.37-01	1.48-01	1.66-01
300	GC	4.72-01	5.57-01	7.58-01	1.08+00	1.24+00	1.51+00	1.68+00	1.97+00	2.14+00	2.41+00
300	GB	3.03-02	3.57-02	4.85-02	6.90-02	7.96-02	9.70-02	1.08-01	1.26-01	1.37-01	1.54-01
310	GC	3.74-01	4.46-01	6.16-01	8.85-01	1.03+00	1.27+00	1.42+00	1.68+00	1.84+00	2.08+00
310	GB	2.40-02	2.87-02	3.95-02	5.69-02	6.64-02	8.17-02	9.13-02	1.08-01	1.18-01	1.34-01
320	GC	2.97-01	3.59-01	5.02-01	7.31-01	8.64-01	1.07+00	1.21+00	1.44+00	1.59+00	1.80+00
320	GB	1.91-02	2.31-02	3.23-02	4.71-02	5.57-02	6.92-02	7.78-02	9.25-02	1.02-01	1.16-01
330	GC	2.37-01	2.89-01	4.11-01	6.06-01	7.26-01	9.10-01	1.03+00	1.24+00	1.38+00	1.57+00
330	GB	1.53-02	1.87-02	2.65-02	3.91-02	4.69-02	5.88-02	6.65-02	7.97-02	8.88-02	1.01-01
340	GC	1.90-01	2.35-01	3.38-01	5.04-01	6.12-01	7.75-01	8.83-01	1.07+00	1.20+00	1.37+00
340	GB	1.23-02	1.52-02	2.19-02	3.26-02	3.96-02	5.01-02	5.71-02	6.90-02	7.74-02	8.88-02
350	GC	1.53-01	1.91-01	2.79-01	4.21-01	5.18-01	6.62-01	7.59-01	9.23-01	1.04+00	1.20+00
350	GB	9.90-03	1.24-02	1.81-02	2.73-02	3.36-02	4.29-02	4.92-02	5.99-02	6.77-02	7.80-02
360	GC	1.23-01	1.56-01	2.31-01	3.53-01	4.40-01	5.67-01	6.55-01	8.02-01	9.13-01	1.06+00
360	GB	8.00-03	1.01-02	1.50-02	2.29-02	2.86-02	3.68-02	4.25-02	5.21-02	5.93-02	6.88-02
370	GC	9.96-02	1.28-01	1.92-01	2.96-01	3.74-01	4.87-01	5.66-01	6.99-01	8.01-01	9.34-01
370	GB	6.49-03	8.31-03	1.25-02	1.93-02	2.44-02	3.17-02	3.69-02	4.55-02	5.22-02	6.08-02
380	GC	8.09-02	1.05-01	1.60-01	2.50-01	3.20-01	4.20-01	4.91-01	6.11-01	7.05-01	8.26-01
380	GB	5.28-03	6.84-03	1.04-02	1.63-02	2.09-02	2.74-02	3.21-02	3.98-02	4.60-02	5.39-02
390	GC	6.58-02	8.64-02	1.33-01	2.11-01	2.74-01	3.63-01	4.28-01	5.35-01	6.22-01	7.33-01
390	GB	4.31-03	5.65-03	8.73-03	1.38-02	1.79-02	2.37-02	2.80-02	3.50-02	4.07-02	4.79-02
400	GC	5.37-02	7.14-02	1.12-01	1.79-01	2.35-01	3.14-01	3.73-01	4.70-01	5.50-01	6.51-01
400	GB	3.52-03	4.68-03	7.33-03	1.17-02	1.54-02	2.06-02	2.44-02	3.08-02	3.61-02	4.27-02
410	GC	4.40-02	5.92-02	9.39-02	1.52-01	2.03-01	2.73-01	3.26-01	4.13-01	4.88-01	5.80-01
410	GB	2.89-03	3.89-03	6.17-03	9.96-03	1.33-02	1.79-02	2.14-02	2.72-02	3.21-02	3.81-02
420	GC	3.61-02	4.92-02	7.91-02	1.29-01	1.75-01	2.38-01	2.89-01	3.65-01	4.34-01	5.18-01
420	GB	2.38-03	3.24-03	5.21-03	8.50-03	1.15-02	1.56-02	1.88-02	2.40-02	2.85-02	3.41-02
430	GC	2.97-02	4.10-02	6.68-02	1.10-01	1.52-01	2.07-01	2.51-01	3.22-01	3.85-01	4.63-01
430	GB	1.96-03	2.71-03	4.41-03	7.27-03	1.00-02	1.37-02	1.66-02	2.13-02	2.55-02	3.06-02
440	GC	2.45-02	3.43-02	5.65-02	9.42-02	1.31-01	1.81-01	2.21-01	2.86-01	3.44-01	4.15-01
440	GB	1.62-03	2.27-03	3.74-03	6.23-03	8.69-03	1.20-02	1.46-02	1.89-02	2.28-02	2.75-02
450	GC	2.03-02	2.87-02	4.79-02	8.07-02	1.14-01	1.59-01	1.95-01	2.54-01	3.08-01	3.73-01
450	GB	1.34-03	1.90-03	3.18-03	5.35-03	7.57-03	1.05-02	1.29-02	1.68-02	2.04-02	2.47-02
460	GC	1.68-02	2.41-02	4.07-02	6.93-02	9.95-02	1.39-01	1.72-01	2.25-01	2.75-01	3.35-01
460	GB	1.11-03	1.60-03	2.70-03	4.60-03	6.61-03	9.28-03	1.14-02	1.50-02	1.83-02	2.23-02
470	GC	1.39-02	2.02-02	3.47-02	5.96-02	8.68-02	1.23-01	1.52-01	2.01-01	2.47-01	3.02-01
470	GB	9.27-04	1.35-03	2.31-03	3.97-03	5.78-03	8.16-03	1.01-02	1.31-02	1.64-02	2.01-02
480	GC	1.16-02	1.71-02	2.96-02	5.14-02	7.59-02	1.08-01	1.35-01	1.79-01	2.22-01	2.72-01
480	GB	7.73-04	1.14-03	1.97-03	3.43-03	5.05-03	7.21-03	9.02-03	1.19-02	1.48-02	1.82-02
490	GC	9.66-03	1.44-02	2.53-02	4.44-02	6.65-02	9.54-02	1.20-01	1.60-01	2.00-01	2.46-01
490	GB	6.46-04	9.63-04	1.69-03	2.97-03	4.44-03	6.38-03	8.03-03	1.07-02	1.33-02	1.65-02
500	GC	8.07-03	1.22-02	2.17-02	3.84-02	5.83-02	8.43-02	1.07-01	1.43-01	1.80-01	2.23-01
500	GB	5.41-04	8.17-04	1.45-03	2.57-03	3.91-03	5.65-03	7.16-03	9.60-03	1.20-02	1.49-02
510	GC	6.76-03	1.03-02	1.85-02	3.32-02	5.12-02	7.46-02	9.52-02	1.28-01	1.62-01	2.02-01
510	GB	4.54-04	6.94-04	1.26-03	2.23-03	3.44-03	5.01-03	6.39-03	8.62-03	1.09-02	1.36-02
520	GC	5.67-03	8.77-03	1.60-02	2.88-02	4.51-02	6.62-02	8.49-02	1.15-01	1.47-01	1.83-01
520	GB	3.81-01	5.91-01	1.07-03	1.94-03	3.03-03	4.45-03	5.72-03	7.75-03	9.85-03	1.23-02
530	GC	4.76-03	7.46-03	1.37-02	2.51-02	3.97-02	5.82-02	7.59-02	1.04-01	1.33-01	1.66-01
530	GB	3.21-04	5.03-04	9.27-04	1.69-03	2.68-03	3.96-03	5.12-03	6.98-03	8.94-03	1.12-02
540	GC	4.01-03	6.36-03	1.18-02	2.18-02	3.51-02	5.22-02	6.79-02	9.32-02	1.20-01	1.51-01
540	GB	2.71-04	4.30-04	8.01-04	1.48-03	2.37-03	3.53-03	4.59-03	6.30-03	8.12-03	1.02-02
550	GC	3.38-03	5.43-03	1.02-02	1.90-02	3.10-02	4.65-02	6.08-02	8.40-02	1.09-01	1.38-01
550	GB	2.29-04	3.68-04	6.93-04	1.29-03	2.10-03	3.15-03	4.12-03	5.69-03	7.38-03	9.33-03

Высота, км	Затраты	Фиксированный уровень солнечной активности $F_{10} \cdot 10^{-22}$ Вт/(м <sup>2</sup> ·Гц)									
		65	75	100	125	150	175	200	225	250	275
560	GC	2.85-03	4.04-03	8.85-03	1.66-02	2.75-02	4.15-02	5.46-02	7.57-02	9.88-02	1.26-01
560	GB	1.93-04	3.15-04	6.01-04	1.13-03	1.85-03	2.82-03	3.70-03	5.14-03	6.71-03	8.53-03
570	GC	2.41-03	3.98-03	7.67-03	1.45-02	2.43-02	3.70-02	4.90-02	6.84-02	8.98-02	1.15-01
570	GB	1.64-04	2.70-04	5.22-04	9.88-04	1.66-03	2.52-03	3.33-03	4.65-03	6.11-03	7.80-03
580	GC	2.01-03	3.41-03	6.65-03	1.27-02	2.16-02	3.31-02	4.41-02	6.19-02	8.17-02	1.05-01
580	GB	1.39-04	2.32-04	4.53-04	8.67-04	1.47-03	2.26-03	3.01-03	4.22-03	5.57-03	7.14-03
590	GC	1.73-03	2.93-03	5.77-03	1.11-02	1.92-02	2.96-02	3.97-02	5.60-02	7.45-02	9.57-02
590	GB	1.18-04	2.00-04	3.95-04	7.61-04	1.31-03	2.02-03	2.71-03	3.83-03	5.09-03	6.54-03
600	GC	1.47-03	2.52-03	5.02-03	9.78-03	1.71-02	2.65-02	3.58-02	5.07-02	6.79-02	8.76-02
600	GB	1.01-04	1.72-04	3.44-04	6.69-04	1.17-03	1.82-03	2.45-03	3.47-03	4.65-03	6.00-03
610	GC	1.08-03	1.76-03	4.08-03	8.45-03	1.53-02	2.38-02	3.73-02	5.59-02	7.73-02	1.07-01
610	GB	7.40-05	1.21-04	2.80-04	5.80-04	1.05-03	1.63-03	2.56-03	3.84-03	5.31-03	7.35-03
620	GC	9.31-04	1.44-03	3.45-03	7.42-03	1.37-02	2.15-02	3.38-02	5.08-02	7.05-02	9.79-02
620	GB	6.40-05	9.91-05	2.37-04	5.10-04	9.42-04	1.48-03	2.33-03	3.49-03	4.85-03	6.73-03
630	GC	8.13-04	1.21-03	2.95-03	6.54-03	1.23-02	1.94-02	3.07-02	4.61-02	6.43-02	8.94-02
630	GB	5.60-05	8.36-05	2.03-04	4.51-04	8.45-04	1.33-03	2.11-03	3.18-03	4.43-03	6.16-03
640	GC	7.17-04	1.04-03	2.55-03	5.79-03	1.10-02	1.75-02	2.78-02	4.19-02	5.86-02	8.16-02
640	GB	4.95-05	7.19-05	1.76-04	4.00-04	7.60-04	1.21-03	1.92-03	2.90-03	4.05-03	5.64-03
650	GC	6.36-04	9.06-04	2.23-03	5.12-03	9.88-03	1.58-02	2.53-02	3.81-02	5.35-02	7.45-02
650	GB	4.41-05	6.27-05	1.54-04	3.55-04	6.84-04	1.09-03	1.75-03	2.64-03	3.70-03	5.16-03
670	GC	5.69-04	7.97-04	1.96-03	4.57-03	8.88-03	1.43-02	2.29-02	3.46-02	4.88-02	6.81-02
670	GB	3.95-05	5.53-05	1.36-04	3.17-04	6.16-04	9.92-04	1.59-03	2.40-03	3.38-03	4.72-03
670	GC	5.11-04	7.07-04	1.73-03	4.08-03	7.99-03	1.29-02	2.08-02	3.15-02	4.45-02	6.22-02
670	GB	3.55-05	4.91-05	1.20-04	2.84-04	5.56-04	9.00-04	1.45-03	2.19-03	3.09-03	4.32-03
680	GC	4.61-04	6.31-04	1.54-03	3.65-03	7.20-03	1.17-02	1.89-02	2.86-02	4.06-02	5.68-02
680	GB	3.21-05	4.40-05	1.07-04	2.54-04	5.02-04	8.17-04	1.32-03	1.99-03	2.83-03	3.96-03
690	GC	4.18-04	5.67-04	1.37-03	3.27-03	6.50-03	1.06-02	1.72-02	2.60-02	3.71-02	5.19-02
690	GB	2.92-05	3.96-05	9.69-05	2.28-04	4.54-04	7.42-04	1.20-03	1.82-03	2.59-03	3.62-03
700	GC	3.81-04	5.12-04	1.23-03	2.94-03	5.87-03	9.65-03	1.56-02	2.37-02	3.38-02	4.74-02
700	GB	2.66-05	3.58-05	8.62-05	2.08-04	4.11-04	6.75-04	1.09-03	1.66-03	2.37-03	3.32-03
710	GC	3.47-04	4.64-04	1.11-03	2.65-03	5.31-03	8.76-03	1.42-02	2.16-02	3.09-02	4.34-02
710	GB	2.44-05	3.25-05	7.78-05	1.85-04	3.72-04	6.14-04	9.95-04	1.51-03	2.17-03	3.04-03
720	GC	3.18-04	4.22-04	1.00-03	2.39-03	4.81-03	7.95-03	1.29-02	1.96-02	2.82-02	3.96-02
720	GB	2.23-05	2.97-05	7.04-05	1.68-04	3.38-04	5.60-04	9.06-04	1.38-03	1.98-03	2.78-03
730	GC	2.92-04	3.86-04	9.98-04	2.16-03	4.36-03	7.24-03	1.17-02	1.79-02	2.58-02	3.62-02
730	GB	2.06-05	2.72-05	6.39-05	1.52-04	3.07-04	5.10-04	8.26-04	1.25-03	1.81-03	2.55-03
740	GC	2.69-04	3.54-04	8.25-04	1.96-03	3.95-03	6.59-03	1.07-02	1.63-02	2.36-02	3.31-02
740	GB	1.90-05	2.49-05	5.82-05	1.38-04	2.79-04	4.65-04	7.53-04	1.15-03	1.66-03	2.34-03
750	GC	2.48-04	3.25-04	7.52-04	1.78-03	3.59-03	6.00-03	9.71-03	1.48-02	2.15-02	3.03-02
750	GB	1.75-05	2.30-05	5.31-05	1.25-04	2.54-04	4.24-04	6.87-04	1.05-03	1.52-03	2.14-03
760	GC	2.29-04	2.99-04	6.85-04	1.61-03	3.26-03	5.47-03	8.81-03	1.35-02	1.96-02	2.77-02
760	GB	1.62-05	2.12-05	4.86-05	1.14-04	2.31-04	3.88-04	6.26-04	9.55-04	1.39-03	1.96-03
770	GC	2.12-04	2.76-04	6.28-04	1.47-03	2.97-03	4.99-03	8.05-03	1.23-02	1.79-02	2.53-02
770	GB	1.51-05	1.96-05	4.46-05	1.04-04	2.11-04	3.51-04	5.71-04	8.73-04	1.27-03	1.80-03
780	GC	1.97-04	2.65-04	5.76-04	1.34-03	2.70-03	4.55-03	7.33-03	1.12-02	1.64-02	2.31-02
780	GB	1.40-05	1.82-05	4.10-05	9.53-05	1.92-04	3.24-04	5.21-04	7.97-04	1.17-03	1.65-03
790	GC	1.83-04	2.37-04	5.29-04	1.22-03	2.46-03	4.16-03	6.67-03	1.02-02	1.50-02	2.12-02
790	GB	1.30-05	1.69-05	3.77-05	8.71-05	1.76-04	2.96-04	4.76-04	7.28-04	1.07-03	1.51-03
800	GC	1.70-04	2.20-04	4.87-04	1.12-03	2.25-03	3.80-03	6.08-03	9.31-03	1.37-02	1.94-02
800	GB	1.22-05	1.57-05	3.48-05	7.98-05	1.60-04	2.71-04	4.34-04	6.65-04	9.78-04	1.38-03
810	GC	1.59-04	2.05-04	4.49-04	1.02-03	2.05-03	3.47-03	5.54-03	8.49-03	1.25-02	1.77-02
810	GB	1.13-05	1.47-05	3.22-05	7.32-05	1.47-04	2.49-04	3.97-04	6.08-04	8.96-04	1.27-03
820	GC	1.48-04	1.91-04	4.15-04	9.36-04	1.87-03	3.18-03	5.05-03	7.74-03	1.14-02	1.62-02
820	GB	1.05-05	1.37-05	2.98-05	6.72-05	1.31-04	2.28-04	3.62-04	5.55-04	8.21-04	1.16-03
830	GC	1.38-04	1.78-04	3.83-04	8.59-04	1.71-03	2.91-03	4.60-03	7.06-03	1.05-02	1.48-02
830	GB	9.94-05	1.28-05	2.76-05	6.18-05	1.23-04	2.09-04	3.31-04	5.08-04	7.52-04	1.07-03
840	GC	1.29-04	1.66-04	3.55-04	7.89-04	1.57-03	2.66-03	4.20-03	6.44-03	9.57-03	1.36-02
840	GB	9.32-06	1.20-05	2.56-05	5.68-05	1.13-04	1.92-04	3.03-04	4.61-04	6.89-04	9.77-04
850	GC	1.21-04	1.56-04	3.29-04	7.25-04	1.43-03	2.44-03	3.83-03	5.88-03	8.75-03	1.24-02
850	GB	8.74-06	1.12-05	2.38-05	5.23-05	1.04-04	1.76-04	2.77-04	4.25-04	6.32-04	8.96-04
850	GC	1.14-04	1.46-04	3.06-04	6.67-04	1.31-03	2.24-03	3.49-03	5.37-03	8.00-03	1.14-02
850	GB	8.22-06	1.05-05	2.21-05	4.83-05	9.51-05	1.62-04	2.53-04	3.88-04	5.79-04	8.22-04



Продолжение табл. 4

Высота, км	Загрязн.	Фиксированный уровень солнечной активности $F_{10} \cdot 10^{-22}$ Вт/(м <sup>2</sup> ·Гц)									
		65	75	100	125	150	175	200	225	250	275
870	GC	1.07-01	1.37-04	2.84-04	6.15-04	1.21-03	2.05-03	3.19-03	4.90-03	7.32-03	1.01-02
870	GB	7.73-06	9.91-06	2.06-05	4.45-05	8.74-05	1.49-04	2.31-04	3.55-04	5.31-04	7.51-04
880	GC	1.00-04	1.28-01	2.65-04	5.67-04	1.11-03	1.88-03	2.91-03	4.47-03	6.70-03	9.52-03
880	GB	7.28-05	9.33-06	1.92-05	4.12-05	8.03-05	1.37-04	2.11-04	3.25-04	4.87-04	6.92-04
890	GC	9.42-05	1.21-01	2.46-04	5.23-04	1.02-03	1.73-03	2.66-03	4.09-03	6.13-03	8.71-03
890	GB	6.86-05	8.79-05	1.79-05	3.81-05	7.39-05	1.26-04	1.93-04	2.98-04	4.46-04	6.34-04
900	GC	8.87-05	1.14-04	2.30-04	4.83-04	9.33-04	1.59-03	2.43-03	3.73-03	5.61-03	7.98-03
900	GB	6.47-06	8.28-06	1.68-05	3.52-05	6.80-05	1.16-04	1.77-04	2.72-04	4.03-04	5.82-04
910	GC	8.35-05	1.07-04	2.15-04	4.46-04	8.57-04	1.46-03	2.22-03	3.41-03	5.14-03	7.30-03
910	GB	6.11-06	7.82-06	1.57-05	3.26-05	6.27-05	1.07-04	1.62-04	2.49-04	3.75-04	5.34-04
920	GC	7.88-05	1.01-04	2.01-04	4.13-04	7.89-04	1.34-03	2.03-03	3.12-03	4.70-03	6.69-03
920	GB	5.77-06	7.38-06	1.47-05	3.03-05	5.78-05	9.83-05	1.48-04	2.28-04	3.44-04	4.90-04
930	GC	7.43-05	9.51-05	1.88-04	3.82-04	7.26-04	1.24-03	1.85-03	2.85-03	4.30-03	6.13-03
930	GB	5.45-06	6.98-06	1.38-05	2.81-05	5.33-05	9.07-05	1.36-04	2.09-04	3.16-04	4.50-04
940	GC	7.02-05	8.98-05	1.76-04	3.54-04	6.69-04	1.14-03	1.69-03	2.60-03	3.94-03	5.61-03
940	GB	5.16-06	6.60-06	1.29-05	2.61-05	4.92-05	8.30-05	1.24-04	1.92-04	2.90-04	4.13-04
950	GC	6.63-05	8.48-05	1.64-04	3.29-04	6.16-04	1.05-03	1.55-03	2.38-03	3.61-03	5.14-03
950	GB	4.89-06	6.25-06	1.21-05	2.42-05	4.54-05	7.72-05	1.14-04	1.76-04	2.66-04	3.79-04
950	GC	6.27-05	8.02-05	1.54-05	3.05-04	5.68-04	9.65-04	1.41-03	2.18-03	3.31-03	4.71-03
960	GB	4.63-06	5.92-06	1.14-05	2.25-05	4.20-05	7.13-05	1.04-04	1.61-04	2.44-04	3.48-04
970	GC	5.94-05	7.59-05	1.45-04	2.83-04	5.24-04	8.89-04	1.29-03	1.99-03	3.03-03	4.31-03
970	GB	4.39-06	5.62-06	1.07-05	2.10-05	3.88-05	6.58-05	9.58-05	1.47-04	2.24-04	3.19-04
980	GC	5.62-05	7.19-05	1.36-04	2.63-04	4.84-04	8.20-04	1.18-03	1.82-03	2.77-03	3.95-03
980	GB	4.17-06	5.33-06	1.01-05	1.95-05	3.59-05	6.08-05	8.78-05	1.35-04	2.06-04	2.93-04
990	GC	5.33-05	6.81-05	1.28-04	2.45-04	4.47-04	7.57-04	1.08-03	1.67-03	2.54-03	3.62-03
990	GB	3.96-06	5.06-06	9.49-06	1.82-05	3.32-05	5.62-05	8.05-05	1.24-04	1.89-04	2.69-04
1000	GC	5.05-05	6.46-05	1.20-04	2.28-04	4.13-04	6.98-04	9.91-04	1.53-03	2.33-03	3.32-03
1000	GB	3.76-06	4.81-06	8.95-06	1.70-05	3.07-05	5.20-05	7.38-05	1.14-04	1.73-04	2.47-04
1010	GC	4.79-05	6.13-05	1.13-04	2.12-04	3.82-04	6.45-04	9.07-04	1.40-03	2.13-03	3.04-03
1010	GB	3.57-06	4.57-06	8.44-06	1.58-05	2.85-05	4.81-05	6.77-05	1.04-04	1.59-04	2.27-04
1020	GC	4.55-05	5.82-05	1.06-04	1.98-04	3.53-04	5.96-04	8.31-04	1.28-03	1.96-03	2.79-03
1020	GB	3.40-06	4.35-06	7.96-06	1.48-05	2.64-05	4.45-05	6.21-05	9.56-05	1.46-04	2.08-04
1030	GC	4.32-05	5.53-05	1.00-04	1.84-04	3.27-04	5.50-04	7.61-04	1.17-03	1.79-03	2.55-03
1030	GB	3.24-06	4.14-06	7.52-06	1.38-05	2.45-05	4.12-05	5.70-05	8.78-05	1.34-04	1.91-04
1040	GC	4.11-05	5.26-05	9.46-05	1.72-04	3.02-04	5.09-04	6.97-04	1.07-03	1.64-03	2.34-03
1040	GB	3.08-06	3.94-06	7.10-06	1.29-05	2.27-05	3.82-05	5.23-05	8.05-05	1.23-04	1.76-04
1050	GC	3.90-05	5.00-05	8.93-05	1.61-04	2.80-04	4.71-04	6.39-04	9.83-04	1.51-03	2.15-03
1050	GB	2.94-06	3.76-06	6.71-06	1.21-05	2.11-05	3.54-05	4.89-05	7.39-05	1.13-04	1.61-04
1060	GC	3.71-05	4.76-05	8.43-05	1.50-04	2.60-04	4.35-04	5.85-04	9.01-04	1.38-03	1.97-03
1060	GB	2.80-06	3.58-06	6.35-06	1.13-05	1.96-05	3.28-05	4.41-05	6.79-05	1.04-04	1.48-04
1070	GC	3.53-05	4.53-05	7.96-05	1.40-04	2.41-04	4.03-04	5.36-04	8.25-04	1.27-03	1.8-03
1070	GB	2.67-06	3.42-06	6.01-06	1.05-05	1.82-05	3.04-05	4.05-05	6.23-05	9.57-05	1.36-04
1080	GC	3.36-05	4.31-05	7.52-05	1.31-04	2.23-04	3.73-04	4.92-04	7.55-04	1.16-03	1.65-03
1080	GB	2.55-06	3.26-06	5.69-06	9.92-05	1.69-05	2.82-05	3.72-05	5.72-05	8.80-05	1.25-04
1090	GC	3.20-05	4.11-05	7.11-05	1.23-04	2.07-04	3.46-04	4.51-04	6.93-04	1.07-03	1.52-03
1090	GB	2.43-06	3.12-06	5.39-06	9.30-05	1.57-05	2.62-05	3.42-05	5.26-05	8.03-05	1.15-04
1100	GC	3.07-05	3.92-05	6.73-05	1.15-04	1.92-04	3.20-04	4.14-04	6.36-04	9.78-04	1.39-03
1100	GB	2.32-06	2.98-06	5.11-06	8.72-06	1.46-05	2.43-05	3.14-05	4.83-05	7.43-05	1.06-04
1110	GC	2.91-05	3.74-05	6.37-05	1.08-04	1.79-04	2.97-04	3.79-04	5.83-04	8.98-04	1.28-03
1110	GB	2.22-06	2.84-06	4.85-06	8.19-06	1.35-05	2.26-05	2.83-05	4.44-05	6.83-05	9.72-05
1120	GC	2.78-05	3.57-05	6.03-05	1.01-04	1.63-04	2.75-04	3.48-04	5.35-04	8.24-04	1.17-03
1120	GB	2.12-06	2.72-06	4.60-06	7.68-06	1.27-05	2.10-05	2.65-05	4.08-05	6.28-05	8.93-05
1130	GC	2.65-05	3.40-05	5.71-05	9.44-05	1.51-04	2.55-04	3.19-04	4.90-04	7.56-04	1.07-03
1130	GB	2.03-06	2.60-06	4.37-06	7.22-06	1.18-05	1.93-05	2.44-05	3.75-05	5.78-05	8.21-05
1140	GC	2.53-05	3.25-05	5.42-05	8.83-05	1.44-04	2.37-04	2.93-04	4.50-04	6.94-04	9.21-04
1140	GB	1.94-06	2.49-06	4.15-06	6.78-06	1.10-05	1.81-05	2.24-05	3.45-05	5.31-05	7.85-05
1150	GC	2.42-05	3.11-05	5.14-05	8.31-05	1.34-04	2.20-04	2.63-04	4.13-04	6.37-04	9.55-04
1150	GB	1.83-06	2.38-06	3.94-06	6.38-06	1.02-05	1.69-05	2.06-05	3.17-05	4.83-05	7.04-05
1160	GC	2.31-05	2.97-05	4.87-05	7.82-05	1.24-04	2.01-04	2.47-04	3.79-04	5.85-04	8.94-04
1160	GB	1.77-06	2.28-06	3.75-06	6.03-06	9.55-05	1.27-05	1.90-05	2.91-05	4.50-05	6.30-05
1170	GC	2.21-05	2.84-05	4.62-05	7.32-05	1.16-04	1.93-04	2.27-04	3.18-04	5.37-04	7.38-04
1170	GB	1.70-06	2.19-06	3.55-06	5.64-06	8.91-05	1.43-05	1.75-05	2.68-05	4.11-05	5.87-05
1180	GC	2.11-05	2.72-05	4.39-05	6.88-05	1.08-04	1.76-04	2.08-04	3.19-04	4.93-04	7.04-04
1180	GB	1.63-06	2.10-06	3.39-06	5.31-06	8.32-05	1.36-05	1.61-05	2.46-05	3.81-05	5.39-05

Высота, км	Загрязн	Фиксированный уровень солнечной активности $F_{10.7}$ , $10^{-22}$ Вт/(м <sup>2</sup> ·Гц)									
		65	75	100	125	150	175	200	225	250	275
1190	GC	2.02-05	2.60-05	4.17-05	6.47-05	1.00-04	1.64-04	1.91-04	2.93-04	4.53-04	6.41-04
1190	GB	1.56-06	2.01-06	3.23-06	5.00-06	7.77-06	1.27-05	1.48-05	2.27-05	3.50-05	4.96-05
1200	GC	1.93-05	2.49-05	3.96-05	6.08-05	9.36-05	1.52-04	1.76-04	2.69-04	4.16-04	5.89-04
1200	GB	1.50-06	1.93-06	3.07-06	4.71-06	7.25-06	1.18-05	1.36-05	2.09-05	3.22-05	4.56-05
1210	GC	1.85-05	2.38-05	3.77-05	5.72-05	8.73-05	1.42-04	1.62-04	2.47-04	3.82-04	5.40-04
1210	GB	1.43-06	1.85-06	2.93-06	4.44-06	6.78-06	1.10-05	1.26-05	1.92-05	2.97-05	4.20-05
1220	GC	1.77-05	2.28-05	3.58-05	5.38-05	8.14-05	1.32-04	1.49-04	2.27-04	3.51-04	4.96-04
1220	GB	1.38-06	1.77-06	2.79-06	4.19-06	6.33-06	1.03-05	1.16-05	1.77-05	2.73-05	3.86-05
1230	GC	1.69-05	2.19-05	3.41-05	5.07-05	7.60-05	1.23-04	1.37-04	2.09-04	3.22-04	4.55-04
1230	GB	1.32-06	1.70-06	2.66-06	3.95-06	5.92-06	9.56-06	1.07-05	1.63-05	2.51-05	3.53-05
1240	GC	1.62-05	2.09-05	3.24-05	4.77-05	7.09-05	1.14-04	1.26-04	1.92-04	2.96-04	4.18-04
1240	GB	1.27-06	1.64-06	2.53-06	3.73-06	5.54-06	8.92-06	9.81-06	1.50-05	2.31-05	3.27-05
1250	GC	1.55-05	2.01-05	3.09-05	4.49-05	6.62-05	1.06-04	1.16-04	1.76-04	2.72-04	3.84-04
1250	GB	1.22-06	1.57-06	2.42-06	3.52-06	5.18-06	8.32-06	9.04-06	1.38-05	2.13-05	3.01-05
1260	GC	1.49-05	1.93-05	2.94-05	4.24-05	6.18-05	9.90-05	1.06-04	1.62-04	2.50-04	3.53-04
1260	GB	1.17-06	1.51-06	2.31-06	3.32-06	4.85-06	7.77-06	8.34-06	1.27-05	1.96-05	2.77-05
1270	GC	1.43-05	1.85-05	2.80-05	3.99-05	5.78-05	9.23-05	9.78-05	1.49-04	2.30-04	3.24-04
1270	GB	1.12-06	1.45-06	2.20-06	3.14-06	4.54-06	7.25-06	7.68-06	1.17-05	1.81-05	2.55-05
1280	GC	1.37-05	1.77-05	2.67-05	3.77-05	5.40-05	8.60-05	9.00-05	1.37-04	2.11-04	2.98-04
1280	GB	1.08-06	1.40-06	2.10-06	2.97-06	4.25-06	6.77-06	7.08-06	1.08-05	1.66-05	2.34-05
1290	GC	1.31-05	1.70-05	2.55-05	3.55-05	5.05-05	8.02-05	8.28-05	1.26-04	1.94-04	2.73-04
1290	GB	1.04-06	1.34-06	2.01-06	2.80-06	3.98-06	6.33-06	6.53-06	9.94-06	1.53-05	2.16-05
1300	GC	1.26-05	1.63-05	2.43-05	3.35-05	4.72-05	7.48-05	7.62-05	1.16-04	1.79-04	2.51-04
1300	GB	9.97-07	1.29-06	1.92-06	2.65-06	3.73-06	5.91-06	6.03-06	9.16-06	1.41-05	1.99-05
1310	GC	1.21-05	1.57-05	2.32-05	3.17-05	4.42-05	6.97-05	7.02-05	1.07-04	1.64-04	2.31-04
1310	GB	9.59-07	1.24-06	1.83-06	2.51-06	3.50-06	5.52-06	5.56-06	8.44-06	1.30-05	1.83-05
1320	GC	1.16-05	1.51-05	2.21-05	2.99-05	4.13-05	6.51-05	6.46-05	9.80-05	1.51-04	2.12-04
1320	GB	9.22-07	1.20-06	1.75-06	2.37-06	3.28-06	5.16-06	5.13-06	7.78-06	1.20-05	1.68-05
1330	GC	1.12-05	1.45-05	2.11-05	2.82-05	3.87-05	6.07-05	5.95-05	9.02-05	1.39-04	1.95-04
1330	GB	8.87-07	1.15-06	1.68-06	2.25-06	3.08-06	4.83-06	4.73-06	7.17-06	1.11-05	1.55-05
1340	GC	1.07-05	1.39-05	2.01-05	2.67-05	3.62-05	5.67-05	5.48-05	8.30-05	1.28-04	1.79-04
1340	GB	8.54-07	1.11-06	1.60-06	2.13-06	2.89-06	4.52-06	4.37-06	6.61-06	1.02-05	1.43-05
1350	GC	1.03-05	1.34-05	1.92-05	2.52-05	3.39-05	5.29-05	5.05-05	7.64-05	1.18-04	1.65-04
1350	GB	8.22-07	1.07-06	1.54-06	2.01-06	2.71-06	4.23-06	4.03-06	6.10-06	9.39-06	1.31-05
1360	GC	9.90-05	1.29-06	1.84-05	2.39-05	3.18-05	4.94-05	4.65-05	7.04-05	1.08-04	1.51-04
1360	GB	7.92-07	1.03-06	1.47-06	1.91-06	2.54-06	3.95-06	3.72-05	5.63-06	8.66-06	1.21-05
1370	GC	9.52-06	1.24-05	1.76-05	2.26-05	2.98-05	4.62-05	4.29-05	6.48-05	9.96-05	1.39-04
1370	GB	7.63-07	9.93-07	1.41-06	1.81-06	2.39-06	3.70-06	3.44-06	5.19-06	7.98-06	1.11-05
1380	GC	9.15-06	1.19-05	1.68-05	2.13-05	2.79-05	4.32-05	3.95-05	5.97-05	9.17-05	1.28-04
1380	GB	7.35-07	9.58-07	1.35-06	1.71-06	2.24-06	3.47-06	3.17-06	4.79-06	7.36-06	1.03-05
1390	GC	8.80-06	1.15-05	1.60-05	2.02-05	2.62-05	4.04-05	3.64-05	5.49-05	8.44-05	1.18-04
1390	GB	7.08-07	9.23-07	1.29-06	1.63-06	2.11-06	3.25-06	2.93-06	4.42-06	6.79-06	9.45-06
1400	GC	8.47-06	1.10-05	1.53-05	1.91-05	2.46-05	3.77-05	3.36-05	5.06-05	7.76-05	1.08-04
1400	GB	6.83-07	8.91-07	1.24-06	1.54-06	1.98-06	3.04-06	2.71-06	4.08-06	6.26-06	8.71-06
1410	GC	8.15-06	1.06-05	1.47-05	1.81-05	2.31-05	3.53-05	3.10-05	4.66-05	7.15-05	9.94-05
1410	GB	6.58-07	8.59-07	1.19-06	1.46-06	1.86-06	2.85-06	2.50-06	3.77-06	5.77-06	8.02-06
1420	GC	7.84-05	1.02-05	1.40-05	1.72-05	2.16-05	3.30-05	2.86-05	4.30-05	6.58-05	9.14-05
1420	GB	6.35-07	8.29-07	1.14-06	1.39-06	1.75-06	2.67-06	2.31-06	3.48-05	5.32-06	7.39-06
1430	GC	7.35-06	9.87-06	1.34-05	1.63-05	2.03-05	3.09-05	2.64-05	3.96-05	6.06-05	8.40-05
1430	GB	6.12-07	8.00-07	1.09-06	1.32-06	1.65-06	2.50-06	2.14-06	3.21-06	4.91-06	6.81-06
1440	GC	7.27-06	9.51-06	1.29-05	1.54-05	1.91-05	2.89-05	2.43-05	3.65-05	5.58-05	7.73-05
1440	GB	5.90-07	7.72-07	1.05-06	1.25-06	1.55-06	2.35-06	1.98-06	2.96-06	4.53-06	6.28-06
1450	GC	7.00-06	9.16-06	1.23-05	1.46-05	1.79-05	2.71-05	2.25-05	3.36-05	5.14-05	7.11-05
1450	GB	5.70-07	7.46-07	1.00-06	1.19-06	1.46-06	2.20-06	1.83-06	2.74-06	4.18-06	5.78-06
1460	GC	6.74-06	8.83-06	1.18-05	1.38-05	1.68-05	2.53-05	2.07-05	3.10-05	4.73-05	6.54-05
1460	GB	5.50-07	7.20-07	9.62-07	1.13-06	1.37-06	2.07-06	1.69-06	2.53-06	3.86-06	5.33-06
1470	GC	6.50-06	8.52-06	1.13-05	1.31-05	1.58-05	2.37-05	1.91-05	2.85-05	4.36-05	6.02-05
1470	GB	5.31-07	6.96-07	9.24-07	1.07-06	1.29-06	1.94-06	1.56-06	2.34-06	3.56-06	4.91-06
1480	GC	6.26-06	8.21-06	1.08-05	1.25-05	1.49-05	2.22-05	1.77-05	2.64-05	4.01-05	5.53-05
1480	GB	5.12-07	6.72-07	8.87-07	1.02-06	1.22-06	1.82-06	1.45-06	2.16-06	3.29-06	4.53-06
1490	GC	6.03-06	7.92-06	1.04-05	1.18-05	1.40-05	2.08-05	1.63-05	2.43-05	3.70-05	5.09-05
1490	GB	4.95-07	6.49-07	8.51-07	9.69-07	1.15-06	1.71-06	1.34-06	1.99-06	3.03-06	4.18-06
1490	GC	5.82-06	7.64-06	9.95-06	1.12-05	1.31-05	1.95-05	1.51-05	2.24-05	3.41-05	4.66-05
1500	GB	4.78-07	6.28-07	8.18-07	9.22-07	1.08-06	1.60-06	1.24-06	1.84-06	2.80-06	3.86-06

Таблица 5

Минимальные заураты топлива за сутки (GC) и за виток (GB), кгс

Высота, км	Заураты	Фиксированный уровень солнечной активности $F_{10}^{-22}$ (Вт/(м <sup>2</sup> ·Гц))											
		65	75	100	125	150	175	200	225	250	275		
120	GC	6.46+02	6.46+02	6.46+02	6.46+02	6.46+02	6.46+02	6.46+02	6.46+02	6.46+02	6.46+02	6.46+02	6.46+02
120	GB	3.98+01	3.98+01	3.98+01	3.98+01	3.98+01	3.98+01	3.98+01	3.98+01	3.98+01	3.98+01	3.98+01	3.98+01
125	GC	3.27+02	3.28+02	3.39+02	3.37+02	3.39+02	3.40+02	3.48+02	3.49+02	3.53+02	3.53+02	3.53+02	3.53+02
125	GB	2.01+01	2.02+01	2.09+01	2.08+01	2.09+01	2.09+01	2.14+01	2.15+01	2.17+01	2.17+01	2.18+01	2.18+01
130	GC	1.94+02	1.95+02	2.05+02	2.07+02	2.10+02	2.12+02	2.19+02	2.21+02	2.25+02	2.25+02	2.27+02	2.27+02
130	GB	1.19+01	1.21+01	1.27+01	1.28+01	1.30+01	1.31+01	1.35+01	1.36+01	1.39+01	1.39+01	1.40+01	1.40+01
135	GC	1.24+02	1.26+02	1.34+02	1.38+02	1.42+02	1.44+02	1.49+02	1.52+02	1.55+02	1.55+02	1.57+02	1.57+02
135	GB	7.68+00	7.80+00	8.26+00	8.49+00	8.75+00	8.89+00	9.22+00	9.35+00	9.59+00	9.59+00	9.68+00	9.68+00
140	GC	8.42+01	8.60+01	9.17+01	9.61+01	1.00+02	1.03+02	1.07+02	1.09+02	1.12+02	1.12+02	1.14+02	1.14+02
140	GB	5.20+00	5.32+00	5.67+00	5.94+00	6.20+00	6.34+00	6.60+00	6.74+00	6.93+00	6.93+00	7.02+00	7.02+00
145	GC	5.92+01	6.08+01	6.51+01	6.96+01	7.35+01	7.57+01	7.89+01	8.10+01	8.36+01	8.36+01	8.51+01	8.51+01
145	GB	3.66+00	3.76+00	4.03+00	4.31+00	4.55+00	4.68+00	4.88+00	5.01+00	5.17+00	5.17+00	5.26+00	5.26+00
150	GC	4.28+01	4.42+01	4.75+01	5.18+01	5.53+01	5.73+01	5.98+01	6.17+01	6.39+01	6.39+01	6.52+01	6.52+01
150	GB	2.65+00	2.74+00	2.94+00	3.21+00	3.42+00	3.55+00	3.71+00	3.82+00	3.96+00	3.96+00	4.04+00	4.04+00
155	GC	3.16+01	3.28+01	3.55+01	3.93+01	4.24+01	4.42+01	4.62+01	4.79+01	4.98+01	4.98+01	5.10+01	5.10+01
155	GB	1.96+00	2.04+00	2.19+00	2.44+00	2.63+00	2.74+00	2.87+00	2.97+00	3.09+00	3.09+00	3.16+00	3.16+00
160	GC	2.38+01	2.48+01	2.68+01	3.04+01	3.31+01	3.47+01	3.63+01	3.78+01	3.94+01	3.94+01	4.05+01	4.05+01
160	GB	1.48+00	1.54+00	1.67+00	1.89+00	2.05+00	2.15+00	2.25+00	2.35+00	2.45+00	2.45+00	2.51+00	2.51+00
165	GC	1.82+01	1.91+01	2.05+01	2.38+01	2.62+01	2.76+01	2.89+01	3.02+01	3.16+01	3.16+01	3.25+01	3.25+01
165	GB	1.13+00	1.19+00	1.28+00	1.48+00	1.63+00	1.71+00	1.80+00	1.88+00	1.96+00	1.96+00	2.02+00	2.02+00
170	GC	1.41+01	1.48+01	1.61+01	1.89+01	2.10+01	2.22+01	2.33+01	2.44+01	2.56+01	2.56+01	2.64+01	2.64+01
170	GB	8.76-01	9.23-01	1.00+00	1.17+00	1.30+00	1.38+00	1.44+00	1.52+00	1.59+00	1.59+00	1.65+00	1.65+00
175	GC	1.10+01	1.17+01	1.27+01	1.51+01	1.69+01	1.80+01	1.89+01	1.99+01	2.09+01	2.09+01	2.17+01	2.17+01
175	GB	6.87-01	7.27-01	7.90-01	8.42-01	1.06+00	1.12+00	1.18+00	1.24+00	1.30+00	1.30+00	1.35+00	1.35+00
180	GC	8.63+00	9.32+00	1.01+01	1.23+01	1.39+01	1.48+01	1.56+01	1.65+01	1.73+01	1.73+01	1.80+01	1.80+01
180	GB	5.39-01	5.82-01	6.33-01	7.66-01	8.66-01	9.26-01	9.72-01	1.03+00	1.08+00	1.08+00	1.12+00	1.12+00
185	GC	6.98+00	7.04+00	8.35+00	1.02+01	1.16+01	1.25+01	1.32+01	1.40+01	1.47+01	1.47+01	1.54+01	1.54+01
185	GB	4.36-01	4.71-01	5.22-01	6.39-01	7.27-01	7.82-01	8.22-01	8.75-01	9.19-01	9.19-01	9.59-01	9.59-01
190	GC	5.67+00	6.13+00	6.90+00	8.57+00	9.80+00	1.08+01	1.12+01	1.19+01	1.26+01	1.26+01	1.32+01	1.32+01
190	GB	3.55-01	3.83-01	4.32-01	5.38-01	6.13-01	6.63-01	6.99-01	7.47-01	7.87-01	7.87-01	8.23-01	8.23-01
195	GC	4.63+00	5.00+00	5.73+00	7.20+00	8.28+00	9.02+00	9.53+00	1.02+01	1.08+01	1.08+01	1.13+01	1.13+01
195	GB	2.90-01	3.13-01	3.59-01	4.50-01	5.18-01	5.64-01	5.97-01	6.40-01	6.76-01	6.76-01	7.10-01	7.10-01
200	GC	3.79+00	4.11+00	4.77+00	6.06+00	7.02+00	7.69+00	8.16+00	8.80+00	9.32+00	9.32+00	9.81+00	9.81+00
200	GB	2.37-01	2.57-01	2.99-01	3.80-01	4.40-01	4.82-01	5.12-01	5.51-01	5.81-01	5.81-01	6.15-01	6.15-01
205	GC	3.11+00	3.38+00	3.93+00	5.13+00	5.97+00	6.58+00	7.02+00	7.59+00	8.07+00	8.07+00	8.52+00	8.52+00
205	GB	1.95-01	2.12-01	2.50-01	3.22-01	3.75-01	4.13-01	4.40-01	4.76-01	5.05-01	5.05-01	5.35-01	5.35-01
210	GC	2.57+00	2.80+00	3.35+00	4.35+00	5.10+00	5.65+00	6.05+00	6.58+00	7.02+00	7.02+00	7.43+00	7.43+00
210	GB	1.61-01	1.76-01	2.10-01	2.73-01	3.20-01	3.55-01	3.80-01	4.13-01	4.41-01	4.41-01	4.67-01	4.67-01
215	GC	2.13+00	2.32+00	2.82+00	3.70+00	4.36+00	4.87+00	5.24+00	5.72+00	6.12+00	6.12+00	6.50+00	6.50+00
215	GB	1.34-01	1.46-01	1.77-01	2.33-01	2.74-01	3.06-01	3.29-01	3.59-01	3.85-01	3.85-01	4.09-01	4.09-01
220	GC	1.77+00	1.94+00	2.38+00	3.15+00	3.74+00	4.20+00	4.55+00	4.98+00	5.36+00	5.36+00	5.71+00	5.71+00
220	GB	1.11-01	1.22-01	1.50-01	1.99-01	2.36-01	2.64-01	2.86-01	3.14-01	3.37-01	3.37-01	3.60-01	3.60-01
225	GC	1.47+00	1.62+00	2.01+00	2.70+00	3.22+00	3.64+00	3.96+00	4.35+00	4.70+00	4.70+00	5.03+00	5.03+00
225	GB	9.27-02	1.02-01	1.27-01	1.70-01	2.03-01	2.29-01	2.49-01	2.74-01	2.96-01	2.96-01	3.17-01	3.17-01
230	GC	1.23+00	1.36+00	1.71+00	2.31+00	2.78+00	3.15+00	3.45+00	3.82+00	4.14+00	4.14+00	4.44+00	4.44+00
230	GB	7.75-02	8.56-02	1.08-01	1.46-01	1.75-01	1.99-01	2.18-01	2.41-01	2.61-01	2.61-01	2.80-01	2.80-01
235	GC	1.03+00	1.14+00	1.45+00	1.99+00	2.40+00	2.74+00	3.02+00	3.35+00	3.65+00	3.65+00	3.93+00	3.93+00
235	GB	6.50-02	7.21-02	9.18-02	1.25-01	1.52-01	1.73-01	1.91-01	2.12-01	2.31-01	2.31-01	2.48-01	2.48-01
240	GC	8.54-01	9.62-01	1.24+00	1.71+00	2.08+00	2.39+00	2.65+00	2.95+00	3.23+00	3.23+00	3.49+00	3.49+00
240	GB	5.47-02	6.09-02	7.81-02	1.08-01	1.32-01	1.51-01	1.68-01	1.87-01	2.01-01	2.01-01	2.21-01	2.21-01
245	GC	7.28-01	8.14-01	1.06+00	1.47+00	1.81+00	2.09+00	2.33+00	2.61+00	2.87+00	2.87+00	3.10+00	3.10+00
245	GB	4.61-02	5.15-02	6.72-02	9.34-02	1.15-01	1.32-01	1.47-01	1.65-01	1.82-01	1.82-01	1.97-01	1.97-01
250	GC	6.14-01	6.90-01	9.09-01	1.28+00	1.58+00	1.83+00	2.05+00	2.31+00	2.55+00	2.55+00	2.77+00	2.77+00
250	GB	3.83-02	4.37-02	5.76-02	8.08-02	9.99-02	1.16-01	1.30-01	1.46-01	1.62-01	1.62-01	1.75-01	1.75-01
255	GC	5.19-01	5.87-01	7.81-01	1.10+00	1.37+00	1.60+00	1.81+00	2.04+00	2.27+00	2.27+00	2.47+00	2.47+00
255	GB	3.30-02	3.72-02	4.96-02	7.01-02	8.72-02	1.02-01	1.15-01	1.30-01	1.44-01	1.44-01	1.57-01	1.57-01
260	GC	4.40-01	5.00-01	6.72-01	9.59-01	1.20+00	1.41+00	1.60+00	1.81+00	2.03+00	2.03+00	2.21+00	2.21+00
260	GB	2.80-02	3.17-02	4.27-02	6.09-02	7.63-02	8.95-02	1.02-01	1.15-01	1.29-01	1.29-01	1.41-01	1.41-01
265	GC	3.74-01	4.27-01	5.80-01	8.31-01	1.05+00	1.24+00	1.42+00	1.61+00	1.81+00	1.81+00	1.99+00	1.99+00
265	GB	2.38-02	2.71-02	3.69-02	5.30-02	6.69-02	7.88-02	9.03-02	1.03-01	1.15-01	1.15-01	1.26-01	1.26-01
270	GC	3.18-01	3.65-01	5.01-01	7.26-01	9.22-01	1.09+00	1.26+00	1.44+00	1.62+00	1.62+00	1.78+00	1.78+00
270	GB	2.03-02	2.32-02	3.19-02	4.63-02	5.87-02	6.96-02	8.02-02	9.16-02	1.03-01	1.03-01	1.14-01	1.14-01

Высота, км	Затраты	Фиксированный уровень солнечной активности $F_{10}^{-22}$ Вт/(м <sup>2</sup> ·Гн)									
		65	75	100	125	150	175	200	225	250	275
275	GC	2.72-01	3.13-01	4.34-01	6.34-01	8.10-01	9.65-01	1.12+00	1.28+00	1.46+00	1.61+00
275	GB	1.73-02	2.00-02	2.77-02	4.04-02	5.16-02	6.15-02	7.14-02	8.19-02	9.28-02	1.02-01
280	GC	2.32-01	2.69-01	3.76-01	5.54-01	7.13-01	8.53-01	9.98-01	1.15+00	1.31+00	1.45+00
280	GB	1.48-02	1.72-02	2.40-02	3.54-02	4.55-02	5.44-02	6.37-02	7.33-02	8.35-02	9.23-02
285	GC	1.99-01	2.32-01	3.27-01	4.85-01	6.28-01	7.56-01	8.90-01	1.03+00	1.18+00	1.31+00
285	GB	1.27-02	1.48-02	2.09-02	3.10-02	4.01-02	4.83-02	5.69-02	6.57-02	7.52-02	8.34-02
290	GC	1.70-01	2.00-01	2.85-01	4.25-01	5.54-01	6.70-01	7.95-01	9.23-01	1.05+00	1.18+00
290	GB	1.09-02	1.28-02	1.82-02	2.72-02	3.55-02	4.29-02	5.09-02	5.90-02	6.79-02	7.55-02
295	GC	1.46-01	1.73-01	2.48-01	3.73-01	4.90-01	5.95-01	7.11-01	8.29-01	9.58-01	1.07+00
295	GB	9.38-03	1.11-02	1.59-02	2.39-02	3.14-02	3.81-02	4.55-02	5.31-02	6.14-02	6.85-02
300	GC	1.26-01	1.49-01	2.17-01	3.28-01	4.34-01	5.30-01	6.37-01	7.45-01	8.66-01	9.69-01
300	GB	8.08-03	9.58-03	1.39-02	2.10-02	2.78-02	3.40-02	4.09-02	4.78-02	5.55-02	6.21-02
310	GC	9.38-02	1.12-01	1.66-01	2.55-01	3.41-01	4.21-01	5.13-01	6.05-01	7.11-01	8.00-01
310	GB	6.03-03	7.22-03	1.07-02	1.64-02	2.19-02	2.70-02	3.30-02	3.89-02	4.57-02	5.14-02
320	GC	7.02-02	8.52-02	1.28-01	1.99-01	2.70-01	3.36-01	4.16-01	4.94-01	5.86-01	6.63-01
320	GB	4.52-03	5.48-03	8.22-03	1.28-02	1.74-02	2.16-02	2.68-02	3.18-02	3.77-02	4.27-02
330	GC	5.29-02	6.49-02	9.88-02	1.56-01	2.14-01	2.69-01	3.38-01	4.05-01	4.85-01	5.52-01
330	GB	3.41-03	4.19-03	6.38-03	1.01-02	1.38-02	1.74-02	2.18-02	2.61-02	3.13-02	3.56-02
340	GC	4.00-02	4.97-02	7.68-02	1.23-01	1.71-01	2.17-01	2.76-01	3.33-01	4.04-01	4.62-01
340	GB	2.59-03	3.21-03	4.97-03	7.94-03	1.11-02	1.40-02	1.79-02	2.15-02	2.61-02	2.99-02
350	GC	3.04-02	3.83-02	6.00-02	9.71-02	1.37-01	1.75-01	2.27-01	2.75-01	3.37-01	3.87-01
350	GB	1.97-03	2.48-03	3.89-03	6.29-03	8.88-03	1.14-02	1.47-02	1.78-02	2.18-02	2.51-02
360	GC	2.33-02	2.96-02	4.71-02	7.71-02	1.10-01	1.42-01	1.87-01	2.28-01	2.82-01	3.26-01
360	GB	1.51-03	1.92-03	3.06-03	5.01-03	7.16-03	9.25-03	1.21-02	1.48-02	1.84-02	2.12-02
370	GC	1.79-02	2.30-02	3.71-02	6.15-02	8.90-02	1.16-01	1.54-01	1.90-01	2.38-01	2.76-01
370	GB	1.16-03	1.50-03	2.42-03	4.00-03	5.80-03	7.56-03	1.01-02	1.24-02	1.55-02	1.80-02
380	GC	1.38-02	1.80-02	2.94-02	4.92-02	7.22-02	9.49-02	1.28-01	1.59-01	2.00-01	2.34-01
380	GB	8.99-04	1.17-03	1.92-03	3.21-03	4.71-03	6.19-03	8.36-03	1.04-02	1.31-02	1.53-02
390	GC	1.07-02	1.41-02	2.33-02	3.95-02	5.87-02	7.78-02	1.07-01	1.33-01	1.70-01	1.99-01
390	GB	6.98-04	9.21-04	1.53-03	2.59-03	3.84-03	5.09-03	6.98-03	8.70-03	1.11-02	1.30-02
400	GC	8.3-03	1.11-02	1.86-02	3.18-02	4.79-02	6.40-02	8.90-02	1.12-01	1.44-01	1.70-01
400	GB	5.44-04	7.26-04	1.22-03	2.09-03	3.14-03	4.20-03	5.84-03	7.33-03	9.44-03	1.11-02
410	GC	6.47-03	8.75-03	1.49-02	2.57-02	3.92-02	5.29-02	7.45-02	9.43-02	1.23-01	1.45-01
410	GB	4.25-04	5.75-04	9.78-04	1.69-03	2.58-03	3.47-03	4.90-03	6.19-03	8.05-03	9.55-03
420	GC	5.07-03	6.94-03	1.19-02	2.09-02	3.22-02	4.38-02	6.26-02	7.97-02	1.05-01	1.25-01
420	GB	3.34-04	4.57-04	7.87-04	1.37-03	2.12-03	2.88-03	4.12-03	5.25-03	6.89-03	8.20-03
430	GC	3.98-03	5.52-03	9.02-03	1.70-02	2.65-02	3.63-02	5.27-02	6.75-02	8.95-02	1.07-01
430	GB	2.63-04	3.64-04	6.35-04	1.12-03	1.75-03	2.40-03	3.48-03	4.46-03	5.91-03	7.07-03
440	GC	3.14-03	4.40-03	7.77-03	1.38-02	2.19-02	3.02-02	4.45-02	5.74-02	7.68-02	9.23-02
440	GB	2.08-04	2.91-04	5.14-04	9.16-04	1.45-03	2.00-03	2.94-03	3.79-03	5.08-03	6.11-03
450	GC	2.48-03	3.52-03	6.29-03	1.13-02	1.81-02	2.52-02	3.76-02	4.88-02	6.60-02	7.97-02
450	GB	1.65-04	2.34-04	4.17-04	7.51-04	2.20-03	1.67-03	2.49-03	3.24-03	4.38-03	5.29-03
460	GC	1.97-03	2.83-03	5.11-03	9.28-03	1.50-02	2.11-02	3.19-02	4.17-02	5.69-02	6.90-02
460	GB	1.31-04	1.88-04	3.39-04	6.17-04	9.98-04	1.40-03	2.12-03	2.77-03	3.78-03	4.59-03
470	GC	1.57-03	2.28-03	4.16-03	7.63-03	1.25-02	1.77-02	2.71-02	3.56-02	4.91-02	5.99-02
470	GB	1.04-04	1.52-04	2.77-04	5.08-04	8.32-04	1.18-03	1.81-03	2.37-03	3.27-03	3.99-03
480	GC	1.25-03	1.84-03	3.40-03	6.29-03	1.04-02	1.49-02	2.31-02	3.05-02	4.25-02	5.20-02
480	GB	8.35-05	1.23-04	2.27-04	4.20-04	6.95-04	9.91-04	1.54-03	2.04-03	2.83-03	3.47-03
490	GC	1.00-03	1.49-03	2.78-03	5.19-03	8.71-03	1.25-02	1.97-02	2.62-02	3.68-02	4.53-02
490	GB	6.69-05	9.96-05	1.86-04	3.47-04	5.82-04	8.36-04	1.32-03	1.75-03	2.46-03	3.03-03
500	GC	8.03-04	1.21-03	2.28-03	4.30-03	7.29-03	1.05-02	1.69-02	2.26-02	3.20-02	3.95-02
500	GB	5.38-05	8.10-05	1.53-04	2.88-04	4.89-04	7.07-04	1.13-03	1.51-03	2.14-03	2.65-03
510	GC	6.46-04	9.84-04	1.87-03	3.57-03	6.12-03	8.92-03	1.44-02	1.95-02	2.78-02	3.45-02
510	GB	4.34-05	6.61-05	1.26-04	2.39-04	4.11-04	5.99-04	9.70-04	1.31-03	1.87-03	2.32-03
520	GC	5.21-04	8.03-04	1.54-03	2.96-03	5.14-03	7.55-03	1.24-02	1.68-02	2.42-02	3.02-02
520	GB	3.50-05	5.40-05	1.04-04	1.99-04	3.46-04	5.08-04	8.35-04	1.13-03	1.63-03	2.03-03
530	GC	4.21-04	6.56-04	1.28-03	2.47-03	4.33-03	6.41-03	1.07-02	1.45-02	2.12-02	2.65-02
530	GB	2.84-05	4.43-05	8.60-05	1.66-04	2.92-04	4.32-04	7.20-04	9.80-04	1.43-03	1.79-03
540	GC	3.41-04	5.38-04	1.06-03	2.06-03	3.66-03	5.45-03	9.19-03	1.26-02	1.85-02	2.33-02
540	GB	2.30-05	3.64-05	7.13-05	1.39-04	2.47-04	3.68-04	6.21-04	8.51-04	1.25-03	1.57-03
550	GC	2.77-04	4.42-04	8.75-04	1.72-03	3.09-03	4.64-03	7.93-03	1.09-02	1.62-02	2.05-02
550	GB	1.87-05	2.99-05	5.93-05	1.17-04	2.10-04	3.14-04	5.37-04	7.40-04	1.10-03	1.39-03



Высота, км	Затраты	Фиксированный уровень солнечной активности $F_{10} \cdot 10^{-22}$ Вт/(м <sup>2</sup> ·Гц)									
		65	75	100	125	150	175	200	225	250	275
560	GC	2.25-04	3.63-04	7.27-04	1.44-03	2.62-03	3.96-03	6.85-03	9.50-03	1.42-02	1.80-02
560	GB	1.53-05	2.47-05	4.94-05	9.79-05	1.78-04	2.69-04	4.65-04	6.45-04	9.65-04	1.22-03
570	GC	1.83-04	3.00-04	6.05-04	1.21-03	2.22-03	3.38-03	5.93-03	8.27-03	1.25-02	1.59-02
570	GB	1.25-05	2.04-05	4.12-05	8.24-05	1.51-04	2.30-04	4.04-04	5.63-04	8.49-04	1.08-03
580	GC	1.50-04	2.48-04	5.05-04	1.02-03	1.89-03	2.89-03	5.14-03	7.21-03	1.10-02	1.40-02
580	GB	1.02-05	1.69-05	3.44-05	6.94-05	1.29-04	1.97-04	3.51-04	4.92-04	7.48-04	9.56-04
590	GC	1.23-04	2.05-04	4.22-04	8.57-04	1.61-03	2.48-03	4.47-03	6.29-03	9.67-03	1.24-02
590	GB	8.37-06	1.40-05	2.88-05	5.85-05	1.10-04	1.69-04	3.05-04	4.30-04	6.61-04	8.47-04
600	GC	1.00-04	1.70-04	3.53-04	7.23-04	1.37-03	2.13-03	3.88-03	5.50-03	8.52-03	1.10-02
600	GB	6.88-06	1.16-05	2.42-05	4.95-05	9.39-05	1.46-04	2.66-04	3.77-04	5.84-04	7.52-04
610	GC	8.79-05	1.54-04	3.19-04	6.52-04	1.23-03	1.88-03	3.50-03	4.88-03	7.72-03	9.81-03
610	GB	6.03-06	1.06-05	2.19-05	4.47-05	8.47-05	1.29-04	2.40-04	3.35-04	5.29-04	6.73-04
620	GC	8.11-05	1.37-04	2.82-04	5.73-04	1.08-03	1.68-03	3.07-03	4.36-03	6.83-03	8.82-03
620	GB	5.58-06	9.41-06	1.94-05	3.94-05	7.45-05	1.16-04	2.11-04	3.00-04	4.69-04	6.06-04
630	GC	7.49-05	1.22-04	2.51-04	5.07-04	9.55-04	1.51-03	2.71-03	3.90-03	6.06-03	7.94-03
630	GB	5.16-06	8.42-06	1.73-05	3.50-05	6.58-05	1.04-04	1.87-04	2.69-04	4.17-04	5.47-04
640	GC	6.94-05	1.10-04	2.25-04	4.52-04	8.48-04	1.35-03	2.40-03	3.50-03	5.38-03	7.15-03
640	GB	4.79-06	7.58-06	1.53-05	3.12-05	5.85-05	9.35-05	1.66-04	2.42-04	3.72-04	4.94-04
650	GC	6.43-05	9.91-05	2.02-04	4.04-04	7.55-04	1.22-03	2.13-03	3.15-03	4.80-03	6.45-03
650	GB	4.45-06	6.86-06	1.40-05	2.80-05	5.23-05	8.45-05	1.48-04	2.18-04	3.32-04	4.47-04
660	GC	5.97-05	8.99-05	1.83-04	3.64-04	6.76-04	1.10-03	1.90-03	2.83-03	4.29-03	5.83-03
660	GB	4.14-06	6.24-06	1.27-05	2.52-05	4.69-05	7.65-05	1.32-04	1.97-04	2.97-04	4.04-04
670	GC	5.55-05	8.19-05	1.66-04	3.28-04	6.07-04	9.99-04	1.70-03	2.56-03	3.84-03	5.27-03
670	GB	3.86-06	5.69-06	1.16-05	2.28-05	4.22-05	6.94-05	1.18-04	1.78-04	2.67-04	3.66-04
680	GC	5.17-05	7.49-05	1.52-04	2.97-04	5.47-04	9.07-04	1.52-03	2.31-03	3.44-03	4.77-03
680	GB	3.60-06	5.22-06	1.06-05	2.07-05	3.81-05	6.32-05	1.06-04	1.61-04	2.40-04	3.32-04
690	GC	4.81-05	6.86-05	1.39-04	2.70-04	4.95-04	8.25-04	1.37-03	2.09-03	3.09-03	4.33-03
690	GB	3.36-06	4.79-06	9.67-06	1.88-05	3.45-05	5.76-05	9.54-05	1.46-04	2.16-04	3.02-04
700	GC	4.49-05	6.31-05	1.27-04	2.46-04	4.49-04	7.52-04	1.23-03	1.90-03	2.78-03	3.92-03
700	GB	3.14-06	4.42-06	8.88-06	1.72-05	3.14-05	5.26-05	8.61-05	1.33-04	1.96-04	2.75-04
710	GC	4.20-05	5.82-05	1.17-04	2.25-04	4.08-04	6.86-04	1.11-03	1.72-03	2.51-03	3.56-03
710	GB	2.94-06	4.08-06	8.18-06	1.58-05	2.86-05	4.81-05	7.79-05	1.21-04	1.76-04	2.50-04
720	GC	3.92-05	5.37-05	1.08-04	2.06-04	3.71-04	6.28-04	1.01-03	1.57-03	2.26-03	3.24-03
720	GB	2.76-06	3.78-06	7.56-06	1.45-05	2.61-05	4.41-05	7.06-05	1.10-04	1.59-04	2.28-04
730	GC	3.67-05	4.98-05	9.93-05	1.89-04	3.39-04	5.75-04	9.11-04	1.43-03	2.05-03	2.95-03
730	GB	2.59-06	3.50-06	6.99-06	1.33-05	2.39-05	4.05-05	6.41-05	1.00-04	1.44-04	2.08-04
740	GC	3.44-05	4.62-05	9.19-05	1.74-04	3.10-04	5.28-04	8.27-04	1.30-03	1.85-03	2.68-03
740	GB	2.43-06	3.26-06	6.49-06	1.23-05	2.19-05	3.72-05	5.84-05	1.18-05	1.31-04	1.89-04
750	GC	3.23-05	4.29-05	8.52-05	1.60-04	2.85-04	4.85-04	7.52-04	1.19-03	1.68-03	2.45-03
750	GB	2.28-06	3.03-06	6.03-06	1.13-05	2.01-05	3.43-05	5.32-05	8.40-05	1.19-04	1.73-04
760	GC	3.03-05	3.99-05	7.91-05	1.48-04	2.61-04	4.46-04	6.85-04	1.09-03	1.52-03	2.23-03
760	GB	2.15-06	2.83-06	5.61-06	1.05-05	1.85-05	3.16-05	4.86-05	7.69-05	1.08-04	1.58-04
770	GC	2.84-05	3.72-05	7.36-05	1.37-04	2.40-04	4.11-04	6.25-04	9.94-04	1.39-03	2.04-03
770	GB	2.02-06	2.64-06	5.23-06	9.71-06	1.71-05	2.92-05	4.44-05	7.06-05	9.84-05	1.45-04
780	GC	2.67-05	3.48-05	6.86-05	1.27-04	2.21-04	3.79-04	5.71-04	9.10-04	1.26-03	1.86-03
780	GB	1.90-06	2.47-06	4.88-06	9.01-06	1.58-05	2.70-05	4.07-05	6.48-05	8.98-05	1.33-04
790	GC	2.52-05	3.25-05	6.40-05	1.17-04	2.04-04	3.50-04	5.23-04	8.35-04	1.18-03	1.70-03
790	GB	1.79-06	2.32-06	4.56-06	8.38-06	1.46-05	2.50-05	3.73-05	5.95-05	8.20-05	1.21-04
800	GC	2.37-05	3.05-05	5.98-05	1.09-04	1.89-04	3.24-04	4.79-04	7.67-04	1.05-03	1.56-03
800	GB	1.69-06	2.18-06	4.27-06	7.80-06	1.35-05	2.31-05	3.42-05	5.48-05	7.49-05	1.11-04
810	GC	2.23-05	2.86-05	5.59-05	1.02-04	1.75-04	3.00-04	4.40-04	7.05-04	9.58-04	1.43-03
810	GB	1.60-06	2.04-06	4.00-06	7.27-06	1.25-05	2.15-05	3.15-05	5.04-05	6.86-05	1.02-04
820	GC	2.10-05	2.68-05	5.24-05	9.45-05	1.62-04	2.78-04	4.04-04	6.48-04	8.76-04	1.31-03
820	GB	1.51-06	1.92-06	3.76-06	6.78-06	1.16-05	1.99-05	2.90-05	4.65-05	6.28-05	9.39-05
830	GC	1.99-05	2.52-05	4.91-05	8.82-05	1.50-04	2.58-04	3.71-04	5.97-04	8.02-04	1.20-03
830	GB	1.43-06	1.81-06	3.53-06	6.34-06	1.08-05	1.85-05	2.67-05	4.29-05	5.76-05	8.63-05
840	GC	1.87-05	2.37-05	4.61-05	8.23-05	1.40-04	2.39-04	3.42-04	5.50-04	7.34-04	1.10-03
840	GB	1.35-06	1.71-06	3.32-06	5.93-06	1.01-05	1.72-05	2.46-05	3.96-05	5.29-05	7.94-05
850	GC	1.77-05	2.23-05	4.33-05	7.69-05	1.30-04	2.22-04	3.15-04	5.07-04	6.73-04	1.01-03
850	GB	1.28-06	1.61-06	3.12-06	5.55-06	9.37-06	1.61-05	2.28-05	3.66-05	4.86-05	7.31-05
860	GC	1.67-05	2.10-05	4.07-05	7.19-05	1.21-04	2.07-04	2.91-04	4.68-04	6.18-04	9.30-04
860	GB	1.21-06	1.52-06	2.94-06	5.20-06	8.74-06	1.50-05	2.10-05	3.39-05	4.47-05	6.73-05

Высота, км	Затраты	Фиксированный уровень солнечной активности $F_{10}^{-22} V_T / (\text{м}^2 \cdot \text{Гн})$									
		65	75	100	125	150	175	200	225	250	275
870	GC	1.58-05	1.98-05	3.83-05	6.74-05	1.12-04	1.93-04	2.69-04	4.33-04	5.68-04	8.56-04
870	GB	1.15-06	1.44-06	2.78-06	4.88-06	8.16-06	1.40-05	1.95-05	3.14-05	4.12-05	6.20-05
880	GC	1.50-05	1.87-05	3.61-05	6.31-05	1.05-04	1.79-04	2.48-04	4.00-04	5.22-04	7.88-04
880	GB	1.09-06	1.36-06	2.62-06	4.59-06	7.62-06	1.30-05	1.80-05	2.91-05	3.79-05	5.72-05
890	GC	1.42-05	1.77-05	3.40-05	5.92-05	9.79-05	1.67-04	2.30-04	3.70-04	4.80-04	7.25-04
890	GB	1.03-06	1.29-06	2.48-06	4.31-06	7.13-06	1.22-05	1.67-05	2.69-05	3.50-05	5.28-05
900	GC	1.34-05	1.67-05	3.21-05	5.56-05	9.15-05	1.56-04	2.13-04	3.43-04	4.42-04	6.68-04
900	GB	9.81-07	1.22-06	2.34-06	4.06-06	6.68-06	1.14-05	1.55-05	2.50-05	3.23-05	4.88-05
910	GC	1.27-05	1.58-05	3.03-05	5.23-05	8.56-05	1.46-04	1.97-04	3.18-04	4.08-04	6.16-04
910	GB	9.31-07	1.16-06	2.22-06	3.82-06	6.26-06	1.07-05	1.44-05	2.32-05	2.98-05	4.50-05
920	GC	1.21-05	1.50-05	2.87-05	4.91-05	8.01-05	1.36-04	1.83-04	2.94-04	3.76-04	5.68-04
920	GB	8.85-07	1.10-06	2.10-06	3.60-06	5.87-06	9.99-06	1.34-05	2.16-05	2.75-05	4.16-05
930	GC	1.15-05	1.42-05	2.71-05	4.62-05	7.50-05	1.28-04	1.70-04	2.73-04	3.47-04	5.25-04
930	GB	8.42-07	1.04-06	1.99-06	3.39-06	5.51-06	9.38-06	1.25-05	2.01-05	2.55-05	3.85-05
940	GC	1.09-05	1.35-05	2.57-05	4.36-05	7.03-05	1.19-04	1.58-04	2.54-04	3.21-04	4.85-04
940	GB	8.00-07	9.91-07	1.89-06	3.20-06	5.17-06	8.78-06	1.16-05	1.87-05	2.36-05	3.56-05
950	GC	1.03-05	1.28-05	2.43-05	4.11-05	6.60-05	1.12-04	1.47-04	2.36-04	2.96-04	4.48-04
950	GB	7.62-07	9.42-07	1.79-06	3.03-06	4.86-06	8.24-06	1.08-05	1.74-05	2.18-05	3.30-05
960	GC	9.82-06	1.21-05	2.30-05	3.87-05	6.19-05	1.05-04	1.37-04	2.19-04	2.74-04	4.14-04
960	GB	7.25-07	8.96-07	1.70-06	2.86-06	4.57-06	7.74-06	1.01-05	1.62-05	2.02-05	3.06-05
970	GC	9.34-06	1.15-05	2.18-05	3.65-05	5.82-05	9.82-05	1.27-04	2.04-04	2.54-04	3.83-04
970	GB	6.91-07	8.53-07	1.62-06	2.70-06	4.30-06	7.27-06	9.42-06	1.51-05	1.88-05	2.83-05
980	GC	8.88-06	1.10-05	2.07-05	3.45-05	5.47-05	9.22-05	1.19-04	1.90-04	2.35-04	3.54-04
980	GB	6.58-07	8.13-07	1.54-06	2.56-06	4.05-06	6.84-06	8.80-06	1.41-05	1.74-05	2.63-05
990	GC	8.45-06	1.04-05	1.97-05	3.26-05	5.14-05	8.65-05	1.11-04	1.77-04	2.18-04	3.28-04
990	GB	6.28-07	7.75-07	1.46-06	2.42-06	3.82-06	6.43-06	8.22-06	1.31-05	1.62-05	2.44-05
1000	GC	8.04-06	9.92-06	1.87-05	3.08-05	4.84-05	8.13-05	1.03-04	1.65-04	2.02-04	3.04-04
1000	GB	5.98-07	7.39-07	1.39-06	2.30-06	3.60-06	6.05-06	7.69-06	1.23-05	1.50-05	2.26-05
1010	GC	7.65-06	9.45-06	1.78-05	2.92-05	4.56-05	7.64-05	9.65-05	1.34-04	1.87-04	2.82-04
1010	GB	5.71-07	7.05-07	1.33-06	2.18-06	3.40-06	5.70-06	7.20-06	1.15-05	1.40-05	2.10-05
1020	GC	7.29-06	9.00-06	1.69-05	2.76-05	4.30-05	7.19-05	9.01-05	1.43-04	1.74-04	2.61-04
1020	GB	5.45-07	6.73-07	1.26-06	2.06-06	3.21-06	5.37-06	6.74-06	1.07-05	1.30-05	1.95-05
1030	GC	6.95-06	8.58-06	1.61-05	2.62-05	4.05-05	6.76-05	8.43-05	1.34-04	1.62-04	2.42-04
1030	GB	5.20-07	6.43-07	1.20-06	1.96-06	3.03-06	5.07-06	6.31-06	1.00-05	1.21-05	1.82-05
1040	GC	6.62-06	8.18-06	1.53-05	2.48-05	3.82-05	6.37-05	7.88-05	1.25-04	1.50-04	2.25-04
1040	GB	4.97-07	6.14-07	1.15-06	1.86-06	2.87-06	4.78-06	5.92-06	9.38-06	1.13-05	1.69-05
1050	GC	6.31-06	7.80-06	1.46-05	2.35-05	3.61-05	6.00-05	7.38-05	1.17-04	1.40-04	2.09-04
1050	GB	4.75-07	5.87-07	1.10-06	1.77-06	2.71-06	4.51-06	5.55-06	8.79-06	1.05-05	1.57-05
1060	GC	6.02-06	7.45-06	1.39-05	2.23-05	3.41-05	5.65-05	6.91-05	1.09-04	1.30-04	1.94-04
1060	GB	4.54-07	5.61-07	1.05-06	1.68-06	2.57-06	4.26-06	5.21-06	8.23-06	9.80-06	1.46-05
1070	GC	5.75-06	7.11-06	1.32-05	2.12-05	3.22-05	5.33-05	6.48-05	1.02-04	1.21-04	1.80-04
1070	GB	4.34-07	5.37-07	1.00-06	1.60-06	2.43-06	4.02-06	4.89-06	7.72-06	9.14-06	1.36-05
1080	GC	5.48-06	6.79-06	1.26-05	2.01-05	3.04-05	5.03-05	6.07-05	9.56-05	1.13-04	1.68-04
1080	GB	4.15-07	5.14-07	9.56-07	1.52-06	2.30-06	3.80-06	4.59-06	7.23-06	8.53-06	1.27-05
1090	GC	5.24-06	6.49-06	1.20-05	1.91-05	2.88-05	4.74-05	5.69-05	8.95-05	1.05-04	1.56-04
1090	GB	3.97-07	4.92-07	9.13-07	1.45-06	2.18-06	3.60-06	4.32-06	6.79-06	7.97-06	1.18-05
1100	GC	5.00-06	6.21-06	1.15-05	1.81-05	2.72-05	4.48-05	5.34-05	8.38-05	9.80-05	1.45-04
1100	GB	3.80-07	4.72-07	8.74-07	1.38-06	2.07-06	3.40-06	4.06-06	6.37-06	7.45-06	1.10-05
1110	GC	4.78-06	5.94-06	1.10-05	1.72-05	2.58-05	4.23-05	5.02-05	7.85-05	9.14-05	1.35-04
1110	GB	3.64-07	4.52-07	8.36-07	1.31-06	1.96-06	3.22-06	3.82-06	5.98-06	6.95-06	1.03-05
1120	GC	4.57-06	5.68-06	1.05-05	1.64-05	2.44-05	4.00-05	4.71-05	7.37-05	8.53-05	1.26-04
1120	GB	3.48-07	4.33-07	8.00-07	1.25-06	1.86-06	3.05-06	3.60-06	5.62-06	6.51-06	9.60-06
1130	GC	4.37-06	5.44-06	1.00-05	1.56-05	2.31-05	3.78-05	4.43-05	6.91-05	7.97-05	1.17-04
1130	GB	3.34-07	4.16-07	7.66-07	1.19-06	1.77-06	2.89-06	3.39-06	5.28-06	6.09-06	8.96-06
1140	GC	4.18-06	5.21-06	9.58-06	1.49-05	2.19-05	3.57-05	4.17-05	6.48-05	7.44-05	1.09-04
1140	GB	3.20-07	3.99-07	7.34-07	1.14-06	1.68-06	2.74-06	3.19-06	4.96-06	5.70-06	8.37-06
1150	GC	4.00-06	4.99-06	9.16-06	1.41-05	2.08-05	3.38-05	3.92-05	6.08-05	6.95-05	1.02-04
1150	GB	3.07-07	3.83-07	7.03-07	1.09-06	1.60-06	2.59-06	3.01-06	4.67-06	5.34-06	7.82-06
1160	GC	3.82-06	4.78-06	8.76-06	1.35-05	1.97-05	3.20-05	3.69-05	5.71-05	6.50-05	9.51-05
1160	GB	2.94-07	3.67-07	6.74-07	1.04-06	1.52-06	2.46-06	2.84-06	4.39-06	5.00-06	7.31-06
1170	GC	3.66-06	4.58-06	8.39-06	1.28-05	1.87-05	3.03-05	3.47-05	5.37-05	6.08-05	8.87-05
1170	GB	2.82-07	3.53-07	6.46-07	9.89-07	1.44-06	2.33-06	2.68-06	4.14-06	4.69-06	6.83-06

Высота, км	Затраты	Фиксированный уровень солнечной активности $F_{10} \cdot 10^{-22}$ Вт/(м <sup>2</sup> ·Гц)									
		85	75	100	125	150	175	200	225	250	275
1180	GC	3.50-06	4.39-06	8.03-06	1.22-05	1.78-05	2.87-05	3.27-05	5.04-05	5.69-05	8.28-05
1180	GB	2.70-07	3.39-07	6.20-07	9.45-07	1.37-06	2.21-06	2.53-06	3.89-06	4.40-06	6.39-06
1190	GC	3.35-06	4.21-06	7.69-06	1.17-05	1.69-05	2.72-05	3.08-05	4.74-05	5.33-05	7.73-05
1190	GB	2.59-07	3.26-07	5.95-07	9.03-07	1.31-06	2.10-06	2.38-06	3.67-06	4.12-06	5.98-06
1200	GC	3.21-06	4.04-06	7.36-06	1.11-05	1.61-05	2.58-05	2.91-05	4.46-05	4.99-05	7.22-05
1200	GB	2.49-07	3.13-07	5.71-07	8.63-07	1.24-06	2.00-06	2.25-06	3.46-06	3.87-06	5.60-06
1210	GC	3.08-06	3.88-06	7.06-06	1.05-05	1.53-05	2.44-05	2.74-05	4.20-05	4.68-05	6.75-05
1210	GB	2.39-07	3.01-07	5.48-07	8.26-07	1.19-06	1.90-06	2.13-06	3.20-06	3.63-06	5.24-06
1220	GC	2.95-06	3.72-06	6.76-06	1.01-05	1.45-05	2.32-05	2.59-05	3.95-05	4.38-05	6.31-05
1220	GB	2.30-07	2.90-07	5.26-07	7.90-07	1.13-06	1.80-06	2.01-06	3.07-06	3.41-06	4.91-06
1230	GC	2.83-06	3.57-06	6.49-06	9.69-06	1.38-05	2.20-05	2.44-05	3.72-05	4.11-05	5.90-05
1230	GB	2.21-07	2.79-07	5.06-07	7.56-07	1.08-06	1.71-06	1.90-06	2.90-06	3.20-06	4.60-06
1240	GC	2.71-06	3.43-06	6.22-06	0.26-06	1.31-05	2.09-05	2.30-05	3.50-05	3.86-05	5.51-05
1240	GB	2.12-07	2.68-07	4.85-07	7.23-07	1.03-06	1.63-06	1.80-06	2.74-06	3.01-06	4.31-06
1250	GC	2.60-06	3.30-06	5.97-06	8.85-06	1.25-05	1.98-05	2.18-05	3.30-05	3.62-05	5.16-05
1250	GB	2.04-07	2.58-07	4.67-07	6.93-07	9.79-07	1.55-06	1.70-06	2.58-06	2.83-06	4.04-06
1260	GC	2.50-06	3.17-06	5.73-06	8.46-06	1.19-05	1.88-05	2.06-05	3.11-05	3.40-05	4.83-05
1260	GB	1.96-07	2.49-07	4.49-07	6.63-07	9.34-07	1.48-06	1.61-06	2.44-06	2.66-06	3.79-06
1270	GC	2.39-06	3.05-06	5.50-06	8.09-06	1.13-05	1.79-05	1.94-05	2.93-05	3.19-05	4.52-05
1270	GB	1.88-07	2.39-07	4.32-07	6.36-07	8.91-07	1.40-06	1.53-06	2.30-06	2.51-06	3.55-06
1280	GC	2.30-06	2.93-06	5.28-06	7.74-06	1.08-05	1.70-05	1.84-05	2.76-05	3.00-05	4.23-05
1280	GB	1.81-07	2.31-07	4.16-07	6.09-07	8.51-07	1.34-06	1.45-06	2.18-06	2.36-06	3.33-06
1290	GC	2.21-06	2.82-06	5.07-06	7.40-06	1.03-05	1.61-05	1.74-05	2.61-05	2.81-05	3.97-05
1290	GB	1.74-07	2.22-07	4.00-07	5.81-07	8.12-07	1.27-06	1.37-06	2.06-06	2.22-06	3.13-06
1300	GC	2.12-06	2.71-06	4.87-06	7.08-06	9.81-06	1.54-05	1.64-05	2.46-05	2.65-05	3.72-05
1300	GB	1.67-07	2.14-07	3.85-07	5.60-07	7.76-07	1.21-06	1.30-06	1.95-06	2.09-06	2.94-06
1310	GC	2.03-06	2.61-06	4.68-06	6.78-06	9.36-06	1.46-05	1.56-05	2.32-05	2.49-05	3.48-05
1310	GB	1.61-07	2.07-07	3.71-07	5.37-07	7.41-07	1.16-06	1.23-06	1.84-06	1.97-06	2.76-06
1320	GC	1.95-06	2.51-06	4.50-06	6.49-06	8.93-06	1.39-05	1.47-05	2.19-05	2.34-05	3.27-05
1320	GB	1.55-07	1.99-07	3.57-07	5.15-07	7.09-07	1.10-06	1.17-06	1.74-06	1.86-06	2.59-06
1330	GC	1.88-06	2.42-06	4.32-06	6.22-06	8.52-06	1.32-05	1.39-05	2.07-05	2.20-05	3.06-05
1330	GB	1.49-07	1.92-07	3.44-07	4.94-07	6.77-07	1.05-06	1.11-06	1.65-06	1.75-06	2.44-06
1340	GC	1.80-06	2.33-06	4.16-06	5.95-06	8.13-06	1.26-05	1.32-05	1.61-05	1.70-05	2.47-05
1340	GB	1.44-07	1.85-07	3.31-07	4.75-07	6.48-07	1.00-06	1.05-06	1.56-06	1.65-06	2.29-06
1350	GC	1.73-06	2.24-06	4.00-06	5.71-06	7.76-06	1.20-05	1.25-05	1.85-05	1.95-05	2.70-05
1350	GB	1.38-07	1.79-07	3.19-07	4.56-07	6.20-07	9.57-07	9.99-07	1.48-06	1.56-06	2.15-06
1360	GC	1.67-06	2.16-06	3.85-06	5.47-06	7.41-06	1.14-05	1.19-05	1.75-05	1.84-05	2.53-05
1360	GB	1.33-07	1.73-07	3.08-07	4.38-07	5.93-07	9.13-07	9.49-07	1.40-06	1.47-06	2.02-06
1370	GC	1.60-06	2.08-06	3.70-06	5.25-06	7.08-06	1.09-05	1.13-05	1.65-05	1.73-05	2.38-05
1370	GB	1.29-07	1.67-07	2.97-07	4.20-07	5.67-07	8.71-07	9.02-07	1.33-06	1.39-06	1.90-06
1380	GC	1.54-06	2.01-06	3.56-06	5.03-06	6.77-06	1.04-05	1.07-05	1.56-05	1.63-05	2.23-05
1380	GB	1.24-07	1.61-07	2.83-07	4.04-07	5.43-07	8.32-07	8.57-07	1.26-06	1.31-06	1.79-06
1390	GC	1.48-06	1.93-06	3.43-06	4.83-06	6.47-06	9.88-06	1.01-05	1.48-05	1.54-05	2.10-05
1390	GB	1.19-07	1.56-07	2.76-07	3.88-07	5.20-07	7.95-07	8.14-07	1.19-06	1.24-06	1.69-06
1400	GC	1.43-06	1.86-06	3.30-06	4.63-06	6.18-06	9.32-06	9.61-06	1.40-05	1.45-05	1.97-05
1400	GB	1.15-07	1.50-07	2.66-07	3.73-07	4.98-07	7.59-07	7.74-07	1.13-06	1.17-06	1.59-06
1410	GC	1.37-06	1.80-06	3.18-06	4.44-06	5.91-06	8.98-06	9.12-06	1.33-05	1.37-05	1.85-05
1410	GB	1.11-07	1.45-07	2.57-07	3.59-07	4.77-07	7.25-07	7.36-07	1.07-06	1.10-06	1.50-06
1420	GC	1.32-06	1.74-06	3.06-06	4.27-06	5.65-06	8.57-06	8.66-06	1.26-05	1.29-05	1.74-05
1420	GB	1.07-07	1.40-07	2.48-07	3.45-07	4.57-07	6.93-07	7.01-07	1.02-06	1.04-06	1.41-06
1430	GC	1.27-06	1.67-06	2.95-06	4.10-06	5.41-06	8.18-06	8.22-06	1.19-05	1.22-05	1.64-05
1430	GB	1.03-07	1.36-07	2.39-07	3.32-07	4.38-07	6.63-07	6.67-07	9.61-07	9.87-07	1.33-06
1440	GC	1.23-06	1.62-06	2.85-06	3.93-06	5.18-06	7.80-06	7.81-06	1.13-05	1.15-05	1.51-05
1440	GB	9.96-08	1.31-07	2.31-07	3.19-07	4.20-07	6.34-07	6.35-07	9.15-07	9.34-07	1.25-06
1450	GC	1.18-06	1.56-06	2.74-06	3.78-06	4.95-06	7.45-06	7.42-06	1.07-05	1.09-05	1.45-05
1450	GB	9.61-08	1.27-07	2.23-07	3.07-07	4.03-07	6.06-07	6.04-07	8.69-07	8.83-07	1.18-06
1460	GC	1.14-06	1.51-06	2.64-06	3.63-06	4.74-06	7.11-06	7.06-06	1.01-05	1.03-05	1.36-05
1460	GB	9.27-08	1.23-07	2.16-07	2.96-07	3.87-07	5.80-07	5.75-07	8.25-07	8.36-07	1.11-06
1470	GC	1.10-06	1.45-06	2.55-06	3.49-06	4.54-06	6.79-06	6.71-06	9.60-06	9.68-06	1.28-06
1470	GB	8.95-08	1.19-07	2.08-07	2.85-07	3.71-07	5.55-07	5.48-07	7.84-07	7.91-07	1.05-06
1480	GC	1.06-06	1.40-06	2.46-06	3.35-06	4.35-06	6.49-06	6.38-06	9.10-06	9.15-06	1.21-05
1480	GB	8.64-08	1.15-07	2.01-07	2.74-07	3.56-07	5.31-07	5.22-07	7.45-07	7.49-07	9.89-07
1490	GC	1.02-06	1.36-06	2.37-06	3.22-06	4.17-06	6.20-06	6.07-06	8.63-06	8.65-06	1.14-05
1490	GB	8.34-08	1.11-07	1.95-07	2.64-07	3.42-07	5.08-07	4.98-07	7.08-07	7.09-07	9.33-07
1500	GC	9.80-07	1.31-06	2.29-06	3.10-06	3.99-06	5.92-06	5.77-06	8.19-06	8.18-06	1.07-06
1500	GB	8.05-08	1.08-07	1.88-07	2.55-07	3.28-07	4.87-07	4.74-07	6.73-07	6.72-07	8.81-07

Затраты характеристической скорости за сутки (VC) и за виток (VB), м/с

Высота, км	Затраты	Фиксированный уровень солнечной активности $F_{10.7}$ , $10^{-22}$ Вт/(м <sup>2</sup> ·Гц)												
		65	75	100	125	150	175	200	225	250	275			
130	VC	1.97+02	1.97+02	1.97+02	1.97+02	1.97+02	1.97+02	1.97+02	1.97+02	1.97+02	1.97+02	1.97+02	1.97+02	1.97+02
130	VB	1.17+01	1.17+01	1.17+01	1.17+01	1.17+01	1.17+01	1.17+01	1.17+01	1.17+01	1.17+01	1.17+01	1.17+01	1.17+01
125	VC	1.01+02	1.01+02	1.05+02	1.03+02	1.03+02	1.01+02	1.06+02	1.06+02	1.06+02	1.07+02	1.07+02	1.07+02	1.07+02
125	VB	6.11+00	6.13+00	6.33+00	6.25+00	6.26+00	6.28+00	6.40+00	6.42+00	6.46+00	6.47+00	6.47+00	6.47+00	6.47+00
130	VC	6.10+01	6.16+01	6.45+01	6.44+01	6.51+01	6.58+01	6.74+01	6.80+01	6.83+01	6.83+01	6.83+01	6.83+01	6.83+01
130	VB	3.73+00	3.76+00	3.94+00	3.93+00	3.97+00	4.01+00	4.11+00	4.15+00	4.20+00	4.23+00	4.23+00	4.23+00	4.23+00
135	VC	4.00+01	4.07+01	4.29+01	4.37+01	4.45+01	4.53+01	4.66+01	4.73+01	4.81+01	4.81+01	4.81+01	4.81+01	4.81+01
135	VB	2.46+00	2.50+00	2.63+00	2.68+00	2.73+00	2.78+00	2.85+00	2.90+00	2.95+00	2.98+00	2.98+00	2.98+00	2.98+00
140	VC	2.77+01	2.83+01	3.00+01	3.11+01	3.20+01	3.28+01	3.38+01	3.45+01	3.52+01	3.52+01	3.52+01	3.52+01	3.52+01
140	VB	1.70+00	1.74+00	1.84+00	1.91+00	1.97+00	2.02+00	2.08+00	2.12+00	2.16+00	2.19+00	2.19+00	2.19+00	2.19+00
145	VC	1.98+01	2.04+01	2.17+01	2.29+01	2.38+01	2.46+01	2.53+01	2.60+01	2.66+01	2.71+01	2.71+01	2.71+01	2.71+01
145	VB	1.22+00	1.26+00	1.34+00	1.41+00	1.47+00	1.52+00	1.56+00	1.60+00	1.64+00	1.67+00	1.67+00	1.67+00	1.67+00
150	VC	1.46+01	1.51+01	1.61+01	1.73+01	1.82+01	1.83+01	1.94+01	2.00+01	2.06+01	2.10+01	2.10+01	2.10+01	2.10+01
150	VB	9.03+01	9.33+01	9.94+01	1.07+00	1.12+00	1.17+00	1.20+00	1.24+00	1.27+00	1.30+00	1.30+00	1.30+00	1.30+00
155	VC	1.10+01	1.14+01	1.22+01	1.34+01	1.42+01	1.48+01	1.52+01	1.58+01	1.63+01	1.63+01	1.63+01	1.63+01	1.63+01
155	VB	6.81+01	7.07+01	7.55+01	8.29+01	8.77+01	9.14+01	9.41+01	9.75+01	1.01+00	1.03+00	1.03+00	1.03+00	1.03+00
160	VC	8.42+00	8.79+00	9.40+00	1.05+01	1.12+01	1.17+01	1.21+01	1.26+01	1.30+01	1.34+01	1.34+01	1.34+01	1.34+01
160	VB	5.22+01	5.45+01	5.83+01	6.51+01	6.95+01	7.28+01	7.49+01	7.80+01	8.07+01	8.29+01	8.29+01	8.29+01	8.29+01
165	VC	6.54+00	6.88+00	7.34+00	8.35+00	8.98+00	9.46+00	9.73+00	1.02+01	1.06+01	1.09+01	1.09+01	1.09+01	1.09+01
165	VB	4.06+01	4.26+01	4.56+01	5.18+01	5.57+01	5.87+01	6.04+01	6.32+01	6.55+01	6.75+01	6.75+01	6.75+01	6.75+01
170	VC	5.15+00	5.42+00	5.81+00	6.72+00	7.28+00	7.71+00	7.92+00	8.32+00	8.65+00	8.95+00	8.95+00	8.95+00	8.95+00
170	VB	3.20+01	3.37+01	3.61+01	4.18+01	4.52+01	4.79+01	4.93+01	5.17+01	5.38+01	5.56+01	5.56+01	5.56+01	5.56+01
175	VC	4.09+00	4.33+00	4.64+00	5.46+00	5.96+00	6.34+00	6.51+00	6.85+00	7.16+00	7.42+00	7.42+00	7.42+00	7.42+00
175	VB	2.55+01	2.70+01	2.89+01	3.40+01	3.71+01	3.94+01	4.05+01	4.27+01	4.40+01	4.62+01	4.62+01	4.62+01	4.62+01
180	VC	2.97+00	3.23+00	3.60+00	4.36+00	4.89+00	5.23+00	5.52+00	5.88+00	6.11+00	6.37+00	6.37+00	6.37+00	6.37+00
180	VB	1.85+01	2.02+01	2.24+01	2.72+01	3.05+01	3.26+01	3.44+01	3.66+01	3.81+01	3.97+01	3.97+01	3.97+01	3.97+01
185	VC	2.47+00	2.68+00	3.02+00	3.69+00	4.13+00	4.44+00	4.69+00	5.01+00	5.21+00	5.44+00	5.44+00	5.44+00	5.44+00
185	VB	1.54+01	1.67+01	1.88+01	2.30+01	2.58+01	2.77+01	2.93+01	3.12+01	3.25+01	3.39+01	3.39+01	3.39+01	3.39+01
190	VC	2.06+00	2.23+00	2.54+00	3.14+00	3.50+00	3.79+00	4.01+00	4.30+00	4.47+00	4.68+00	4.68+00	4.68+00	4.68+00
190	VB	1.28+01	1.40+01	1.59+01	1.96+01	2.19+01	2.37+01	2.51+01	2.68+01	2.79+01	2.93+01	2.93+01	2.93+01	2.93+01
195	VC	1.72+00	1.87+00	2.15+00	2.68+00	2.99+00	3.26+00	3.45+00	3.71+00	3.86+00	4.06+00	4.06+00	4.06+00	4.06+00
195	VB	1.08+01	1.17+01	1.35+01	1.68+01	1.87+01	2.04+01	2.16+01	2.32+01	2.42+01	2.54+01	2.54+01	2.54+01	2.54+01
200	VC	1.44+00	1.57+00	1.83+00	2.30+00	2.59+00	2.81+00	2.98+00	3.22+00	3.36+00	3.54+00	3.54+00	3.54+00	3.54+00
200	VB	9.05+02	9.85+02	1.14+01	1.44+01	1.61+01	1.76+01	1.87+01	2.01+01	2.10+01	2.22+01	2.22+01	2.22+01	2.22+01
205	VC	1.22+00	1.33+00	1.56+00	1.97+00	2.21+00	2.43+00	2.59+00	2.80+00	2.94+00	3.10+00	3.10+00	3.10+00	3.10+00
205	VB	7.63+02	8.32+02	9.77+02	1.24+01	1.38+01	1.52+01	1.62+01	1.76+01	1.84+01	1.95+01	1.95+01	1.95+01	1.95+01
210	VC	1.03+00	1.12+00	1.33+00	1.70+00	1.91+00	2.11+00	2.25+00	2.45+00	2.58+00	2.73+00	2.73+00	2.73+00	2.73+00
210	VB	6.46+02	7.05+02	8.37+02	1.07+01	1.20+01	1.33+01	1.42+01	1.54+01	1.62+01	1.72+01	1.72+01	1.72+01	1.72+01
215	VC	8.72+01	9.55+01	1.14+00	1.47+00	1.65+00	1.81+00	1.97+00	2.16+00	2.27+00	2.42+00	2.42+00	2.42+00	2.42+00
215	VB	5.48+02	6.00+02	7.19+02	9.27+02	1.04+01	1.16+01	1.24+01	1.36+01	1.43+01	1.52+01	1.52+01	1.52+01	1.52+01
220	VC	7.41+01	8.14+01	9.85+01	1.28+00	1.44+00	1.61+00	1.73+00	1.90+00	2.01+00	2.14+00	2.14+00	2.14+00	2.14+00
220	VB	4.67+02	5.12+02	6.20+02	8.05+02	9.06+02	1.02+01	1.09+01	1.20+01	1.26+01	1.35+01	1.35+01	1.35+01	1.35+01
225	VC	6.32+01	6.96+01	8.50+01	1.11+00	1.26+00	1.42+00	1.53+00	1.68+00	1.78+00	1.91+00	1.91+00	1.91+00	1.91+00
225	VB	3.98+02	4.39+02	5.36+02	7.02+02	7.92+02	8.93+02	9.62+02	1.06+01	1.12+01	1.20+01	1.20+01	1.20+01	1.20+01
230	VC	5.40+01	5.97+01	7.36+01	9.71+01	1.10+00	1.25+00	1.35+00	1.49+00	1.59+00	1.71+00	1.71+00	1.71+00	1.71+00
230	VB	3.41+02	3.77+02	4.64+02	6.13+02	6.94+02	7.87+02	8.52+02	9.42+02	1.00+01	1.08+01	1.08+01	1.08+01	1.08+01
235	VC	4.63+01	5.13+01	6.39+01	8.50+01	9.66+01	1.10+00	1.20+00	1.33+00	1.42+00	1.53+00	1.53+00	1.53+00	1.53+00
235	VB	2.92+02	3.24+02	4.04+02	5.37+02	6.10+02	6.96+02	7.56+02	8.39+02	8.97+02	9.66+02	9.66+02	9.66+02	9.66+02
240	VC	3.97+01	4.43+01	5.56+01	7.45+01	8.51+01	9.75+01	1.06+00	1.19+00	1.27+00	1.37+00	1.37+00	1.37+00	1.37+00
240	VB	2.51+02	2.80+02	3.52+02	4.71+02	5.38+02	6.16+02	6.72+02	7.50+02	8.04+02	8.69+02	8.69+02	8.69+02	8.69+02
245	VC	3.42+01	3.83+01	4.85+01	6.54+01	7.51+01	8.65+01	9.47+01	1.05+00	1.14+00	1.24+00	1.24+00	1.24+00	1.24+00
245	VB	2.16+02	2.42+02	3.07+02	4.14+02	4.75+02	5.48+02	6.00+02	6.72+02	7.23+02	7.84+02	7.84+02	7.84+02	7.84+02
250	VC	2.95+01	3.31+01	4.24+01	5.76+01	6.64+01	7.69+01	8.46+01	9.51+01	1.03+00	1.12+00	1.12+00	1.12+00	1.12+00
250	VB	1.87+02	2.10+02	2.69+02	3.65+02	4.21+02	4.87+02	5.36+02	6.03+02	6.52+02	7.09+02	7.09+02	7.09+02	7.09+02
255	VC	2.55+01	2.88+01	3.71+01	5.08+01	5.88+01	6.85+01	7.57+01	8.55+01	9.28+01	1.01+00	1.01+00	1.01+00	1.01+00
255	VB	1.62+02	1.83+02	2.36+02	3.23+02	3.73+02	4.35+02	4.83+02	5.42+02	5.83+02	6.42+02	6.42+02	6.42+02	6.42+02
260	VC	2.21+01	2.50+01	3.26+01	4.49+01	5.23+01	6.12+01	6.79+01	7.70+01	8.39+01	9.18+01	9.18+01	9.18+01	9.18+01
260	VB	1.40+02	1.59+02	2.07+02	2.85+02	3.32+02	3.89+02	4.31+02	4.89+02	5.33+02	5.83+02	5.83+02	5.83+02	5.83+02
265	VC	1.91+01	2.18+01	2.86+01	3.98+01	4.65+01	5.48+01	6.10+01	6.94+01	7.60+01	8.34+01	8.34+01	8.34+01	8.34+01
265	VB	1.22+02	1.39+02	1.82+02	2.53+02	2.96+02	3.48+02	3.88+02	4.42+02	4.83+02	5.31+02	5.31+02	5.31+02	5.31+02



Продолжение табл. 6

Высота, км	Загрязн.	Фиксированный уровень солнечной активности $F_{10} \cdot 10^{-22}$ Вт/(м <sup>2</sup> ·Га)									
		65	75	100	125	150	175	200	225	250	275
270	VC	1.66-01	1.91-01	2.52-01	3.53-01	4.15-01	4.91-01	5.49-01	6.28-01	6.89-01	7.59-01
270	VB	1.06-02	1.21-02	1.61-02	2.25-02	2.64-02	3.12-02	3.50-02	4.00-02	4.39-02	4.84-02
275	VC	1.45-01	1.67-01	2.23-01	3.14-01	3.70-01	4.41-01	4.95-01	5.68-01	6.27-01	6.93-01
275	VB	9.23-03	1.06-02	1.42-02	2.00-02	2.36-02	2.81-02	3.16-02	3.62-02	4.00-02	4.41-02
283	VC	1.26-01	1.46-01	1.97-01	2.79-01	3.31-01	3.96-01	4.47-01	5.15-01	5.71-01	6.33-01
280	VB	8.05-03	9.34-03	1.26-02	1.78-02	2.11-02	2.53-02	2.85-02	3.29-02	3.64-02	4.04-02
285	VC	1.10-01	1.29-01	1.74-01	2.49-01	2.97-01	3.57-01	4.05-01	4.68-01	5.21-01	5.79-01
285	VB	7.05-03	8.21-03	1.11-02	1.59-02	1.90-02	2.28-02	2.59-02	2.99-02	3.33-02	3.70-02
290	VC	9.65-02	1.13-01	1.55-01	2.22-01	2.66-01	3.22-01	3.67-01	4.26-01	4.75-01	5.30-01
290	VB	6.18-03	7.23-03	9.88-03	1.42-02	1.70-02	2.06-02	2.34-02	2.72-02	3.04-02	3.39-02
295	VC	8.46-02	9.96-02	1.37-01	1.98-01	2.40-01	2.91-01	3.33-01	3.88-01	4.35-01	4.83-01
295	VB	5.42-03	6.38-03	8.79-03	1.27-02	1.53-02	1.86-02	2.13-02	2.48-02	2.78-02	3.11-02
300	VC	7.42-02	8.79-02	1.22-01	1.78-01	2.16-01	2.63-01	3.02-01	3.54-01	3.98-01	4.47-01
300	VB	4.76-03	5.63-03	7.82-03	1.14-02	1.38-02	1.69-02	1.94-02	2.27-02	2.55-02	2.86-02
310	VC	5.74-02	6.87-02	9.69-02	1.43-01	1.75-01	2.16-01	2.51-01	2.96-01	3.36-01	3.78-01
310	VB	3.69-03	4.42-03	6.23-03	9.17-03	1.13-02	1.39-02	1.61-02	1.93-02	2.16-02	2.43-02
320	VC	4.46-02	5.41-02	7.74-02	1.15-01	1.43-01	1.78-01	2.09-01	2.48-01	2.84-01	3.22-01
320	VB	2.87-03	3.48-03	4.98-03	7.43-03	9.24-03	1.15-02	1.34-02	1.60-02	1.83-02	2.07-02
330	VC	3.48-02	4.27-02	6.21-02	9.37-02	1.18-01	1.48-01	1.75-01	2.09-01	2.41-01	2.75-01
330	VB	2.25-03	2.76-03	4.01-03	6.05-03	7.60-03	9.55-03	1.13-02	1.35-02	1.56-02	1.78-02
340	VC	2.73-02	3.39-02	5.00-02	7.64-02	9.72-02	1.23-01	1.47-01	1.77-01	2.06-01	2.36-01
340	VB	1.77-03	2.20-03	3.24-03	4.94-03	6.29-03	7.97-03	9.49-03	1.15-02	1.33-02	1.53-02
350	VC	2.16-02	2.71-02	4.05-02	6.25-02	8.06-02	1.03-01	1.24-01	1.50-01	1.76-01	2.03-01
350	VB	1.40-03	1.76-03	2.62-03	4.05-03	5.22-03	6.68-03	8.03-03	9.75-03	1.14-02	1.32-02
360	VC	1.71-02	2.17-02	3.29-02	5.14-02	6.70-02	8.65-02	1.05-01	1.28-01	1.52-01	1.76-01
360	VB	1.11-03	1.41-03	2.14-03	3.34-03	4.35-03	5.62-03	6.81-03	8.34-03	9.85-03	1.14-02
370	VC	1.36-02	1.75-02	2.68-02	4.24-02	5.59-02	7.28-02	8.91-02	1.10-01	1.31-01	1.52-01
370	VB	8.83-04	1.14-03	1.75-03	2.76-03	3.64-03	4.74-03	5.89-03	7.15-03	8.52-03	9.92-03
380	VC	1.08-02	1.41-02	2.20-02	3.51-02	4.69-02	6.15-02	7.59-02	9.42-02	1.13-01	1.32-01
380	VB	7.06-04	9.20-04	1.43-03	2.29-03	3.06-03	4.02-03	4.96-03	6.15-03	7.38-03	8.65-03
390	VC	8.66-03	1.14-02	1.80-02	2.91-02	3.94-02	5.21-02	6.49-02	8.11-02	9.82-02	1.16-01
390	VB	5.67-04	7.48-04	1.18-03	1.91-03	2.58-03	3.41-03	4.25-03	5.31-03	6.42-03	7.56-03
400	VC	6.96-03	9.30-03	1.49-02	2.43-02	3.32-02	4.43-02	5.57-02	7.00-02	8.54-02	1.01-01
400	VB	4.56-04	6.09-04	9.74-04	1.59-03	2.18-03	2.91-03	3.65-03	4.59-03	5.60-03	6.62-03
410	VC	5.61-03	7.59-03	1.23-02	2.03-02	2.81-02	3.78-02	4.79-02	6.06-02	7.45-02	8.85-02
410	VB	3.68-04	4.98-04	8.07-04	1.33-03	1.84-03	2.48-03	3.14-03	3.98-03	4.89-03	5.82-03
420	VC	4.54-03	6.21-03	1.02-02	1.70-02	2.38-02	3.23-02	4.13-02	5.26-02	6.51-02	7.78-02
420	VB	2.99-04	4.09-04	6.71-04	1.12-03	1.57-03	2.13-03	2.72-03	3.46-03	4.29-03	5.12-03
430	VC	3.68-03	5.10-03	8.47-03	1.43-02	2.02-02	2.77-02	3.56-02	4.57-02	5.71-02	6.85-02
430	VB	2.43-04	3.37-04	5.59-04	9.41-04	1.33-03	1.83-03	2.35-03	3.02-03	3.77-03	4.52-03
440	VC	2.99-03	4.20-03	7.06-03	1.20-02	1.72-02	2.38-02	3.09-02	3.99-02	5.01-02	6.04-02
440	VB	1.98-04	2.78-04	4.67-04	7.94-04	1.14-03	1.57-03	2.04-03	2.64-03	3.31-03	4.00-03
450	VC	2.44-03	3.47-03	5.90-03	1.01-02	1.47-02	2.05-02	2.68-02	3.48-02	4.41-02	5.34-02
450	VB	1.62-04	2.30-04	3.91-04	6.71-04	9.75-04	1.36-03	1.78-03	2.31-03	2.92-03	3.54-03
460	VC	2.00-03	2.87-03	4.94-03	8.57-03	1.26-02	1.77-02	2.33-02	3.05-02	3.89-02	4.73-02
460	VB	1.33-04	1.91-04	3.28-04	5.69-04	8.37-04	1.17-03	1.55-03	2.03-03	2.58-03	3.14-03
470	VC	1.64-03	2.38-03	4.15-03	7.27-03	1.08-02	1.53-02	2.03-02	2.68-02	3.44-02	4.20-02
470	VB	1.09-04	1.59-04	2.76-04	4.81-04	7.19-04	1.02-03	1.35-03	1.78-03	2.29-03	2.80-03
480	VC	1.34-03	1.98-03	3.50-03	6.17-03	9.29-03	1.32-02	1.78-02	2.35-02	3.04-02	3.73-02
480	VB	8.97-05	1.32-04	2.33-04	4.12-04	6.20-04	8.83-04	1.18-03	1.57-03	2.03-03	2.49-03
490	VC	1.11-03	1.65-03	2.95-03	5.26-03	8.00-03	1.15-02	1.55-02	2.07-02	2.70-02	3.33-02
490	VB	7.40-05	1.11-04	1.97-04	3.52-04	5.35-04	7.68-04	1.04-03	1.38-03	1.80-03	2.22-03
500	VC	9.14-04	1.38-03	2.49-03	4.49-03	6.91-03	9.98-03	1.36-02	1.83-02	2.39-02	2.97-02
500	VB	6.13-05	9.26-05	1.67-04	3.01-04	4.63-04	6.69-04	9.12-04	1.22-03	1.60-03	1.99-03
510	VC	7.57-04	1.16-03	2.11-03	3.83-03	5.97-03	8.70-03	1.20-02	1.61-02	2.13-02	2.65-02
510	VB	5.08-05	7.77-05	1.42-04	2.57-04	4.01-04	5.84-04	8.03-04	1.08-03	1.43-03	1.78-03
520	VC	6.27-04	9.71-04	1.79-03	3.28-03	5.18-03	7.59-03	1.05-02	1.43-02	1.90-02	2.37-02
520	VB	4.22-05	6.54-05	1.21-04	2.21-04	3.48-04	5.11-04	7.08-04	9.60-04	1.28-03	1.60-03
530	VC	5.21-04	8.17-04	1.52-03	2.82-03	4.49-03	6.64-03	9.26-03	1.26-02	1.69-02	2.12-02
530	VB	3.52-05	5.51-05	1.03-04	1.90-04	3.03-04	4.48-04	6.25-04	8.53-04	1.14-03	1.43-03
540	VC	4.34-04	6.88-04	1.30-03	2.42-03	3.90-03	5.81-03	8.17-03	1.12-02	1.51-02	1.91-02
540	VB	2.93-05	4.65-05	8.77-05	1.64-04	2.64-04	3.93-04	5.52-04	7.58-04	1.92-03	1.29-03

Высота, км	Затраги	Фиксированный уровень солнечной активности $F_{10} \cdot 10^{-22}$ Вт/(м <sup>2</sup> ·Гц)									
		65	75	100	125	150	175	200	225	250	275
550	VC	3,62-04	5,81-04	1,11-03	2,08-03	3,40-03	5,09-03	7,22-03	9,97-03	1,35-02	1,71-02
550	VB	2,45-05	3,94-05	7,50-05	1,41-04	2,30-04	3,45-04	4,89-04	6,75-04	9,16-04	1,16-03
560	VC	3,03-04	4,91-04	9,47-04	1,80-03	2,96-03	4,47-03	6,39-03	8,87-03	1,21-02	1,54-02
560	VB	2,05-05	3,31-05	6,43-05	1,22-04	2,01-04	3,04-04	4,34-04	6,02-04	8,23-04	1,05-03
570	VC	2,53-04	4,16-04	8,11-04	1,55-03	2,59-03	3,93-03	5,66-03	7,90-03	1,09-02	1,39-02
570	VB	1,72-05	2,83-05	5,52-05	1,06-04	1,76-04	2,68-04	3,85-04	5,38-04	7,40-04	9,43-04
580	VC	2,13-04	3,53-04	6,95-04	1,34-03	2,26-03	3,46-03	5,02-03	7,05-03	9,76-03	1,25-02
580	VB	1,45-05	2,41-05	4,74-05	9,15-05	1,54-04	2,36-04	3,43-04	4,81-04	6,66-04	8,52-04
590	VC	1,79-04	3,00-04	5,97-04	1,16-03	1,98-03	3,05-03	4,46-03	6,30-03	8,78-03	1,13-02
590	VB	1,22-05	2,05-05	4,08-05	7,94-05	1,35-04	2,09-04	3,05-04	4,30-04	6,00-04	7,71-04
600	VC	1,50-04	2,56-04	5,14-04	1,01-03	1,74-03	2,70-03	3,97-03	5,63-03	7,90-03	1,02-02
600	VB	1,03-05	1,75-05	3,52-05	6,90-05	1,19-04	1,85-04	2,72-04	3,86-04	5,41-04	6,98-04
610	VC	1,15-04	1,94-04	4,31-04	8,89-04	1,59-03	2,45-03	3,93-03	5,64-03	8,07-03	1,11-02
610	VB	7,92-06	1,33-05	2,95-05	6,10-05	1,09-04	1,68-04	2,70-04	3,87-04	5,54-04	7,64-04
620	VC	1,02-04	1,63-04	3,68-04	7,80-04	1,41-03	2,20-03	3,55-03	5,13-03	7,36-03	1,02-02
620	VB	7,00-06	1,12-05	2,53-05	5,37-05	9,71-05	1,51-04	2,44-04	3,53-04	5,06-04	6,99-04
630	VC	9,05-05	1,39-04	3,18-04	6,88-04	1,26-03	1,98-03	3,21-03	4,67-03	6,70-03	9,30-03
630	VB	6,24-06	9,59-06	2,20-05	4,74-05	8,69-05	1,37-04	2,22-04	3,22-04	4,62-04	6,41-04
640	VC	8,10-05	1,21-04	2,78-04	6,09-04	1,13-03	1,79-03	2,91-03	4,26-03	6,11-03	8,50-03
640	VB	5,59-06	8,34-06	1,92-05	4,21-05	7,79-05	1,24-04	2,01-04	2,94-04	4,22-04	5,87-04
650	VC	7,28-05	1,06-04	2,45-04	5,41-04	1,01-03	1,62-03	2,63-03	3,88-03	5,57-03	7,77-03
650	VB	5,04-06	7,34-06	1,69-05	3,75-05	7,00-05	1,12-04	1,82-04	2,69-04	3,83-04	5,38-04
660	VC	6,58-05	9,40-05	2,17-04	4,83-04	9,08-04	1,46-03	2,39-03	3,54-03	5,08-03	7,10-03
660	VB	4,56-06	6,52-06	1,50-05	3,35-05	6,30-05	1,02-04	1,65-04	2,45-04	3,53-04	4,93-04
670	VC	5,97-05	8,39-05	1,93-04	4,32-04	8,17-04	1,33-03	2,16-03	3,22-03	4,64-03	6,50-03
670	VB	4,15-06	5,83-06	1,34-05	3,00-05	5,68-05	9,22-05	1,50-04	2,24-04	3,22-04	4,52-04
680	VC	5,43-05	7,54-05	1,73-04	3,87-04	7,36-04	1,20-03	1,96-03	2,94-03	4,23-03	5,94-03
680	VB	3,78-06	5,26-06	1,20-05	2,70-05	5,13-05	8,38-05	1,37-04	2,05-04	2,93-04	4,14-04
690	VC	4,96-05	6,81-05	1,55-04	3,49-04	6,65-04	1,09-03	1,78-03	2,68-03	3,85-03	5,44-03
690	VB	3,47-06	4,75-06	1,08-05	2,43-05	4,61-05	7,62-05	1,24-04	1,87-04	2,70-04	3,80-04
700	VC	4,54-05	6,17-05	1,40-04	3,14-04	6,01-04	9,92-04	1,62-03	2,45-03	3,53-03	4,97-03
700	VB	3,18-06	4,32-06	9,81-06	2,20-05	4,20-05	6,94-05	1,13-04	1,71-04	2,47-04	3,48-04
710	VC	4,17-05	5,62-05	1,27-04	2,84-04	5,44-04	9,02-04	1,47-03	2,24-03	3,22-03	4,55-03
710	VB	2,93-06	3,94-06	8,89-06	1,99-05	3,82-05	6,33-05	1,03-04	1,57-04	2,26-04	3,19-04
720	VC	3,81-05	5,14-05	1,15-04	2,58-04	4,94-04	8,22-04	1,34-03	2,04-03	2,94-03	4,17-03
720	VB	2,70-06	3,61-06	8,10-06	1,81-05	3,47-05	5,77-05	9,38-05	1,44-04	2,07-04	2,93-04
730	VC	3,54-05	4,71-05	1,05-04	2,34-04	4,48-04	7,49-04	1,21-03	1,87-03	2,69-03	3,82-03
730	VB	2,50-06	3,32-06	7,40-06	1,65-05	3,16-05	5,27-05	8,55-05	1,31-04	1,89-04	2,69-04
740	VC	3,28-05	4,33-05	9,59-05	2,13-04	4,07-04	6,83-04	1,11-03	1,71-03	2,46-03	3,49-03
740	VB	2,31-06	3,05-06	6,77-06	1,50-05	2,87-05	4,82-06	7,80-05	1,20-04	1,74-04	2,46-04
750	VC	3,03-05	3,99-05	8,79-05	1,94-04	3,71-04	6,24-04	1,01-03	1,56-03	2,25-03	3,20-03
750	VB	2,15-06	2,82-06	6,21-06	1,37-05	2,62-05	4,41-05	7,12-05	1,10-04	1,59-04	2,26-04
760	VC	2,82-05	3,68-05	8,05-05	1,77-04	3,38-04	5,70-04	9,17-04	1,43-03	2,06-03	2,93-03
760	VB	2,00-06	2,61-06	5,72-06	1,25-05	2,40-05	4,04-05	6,50-05	1,01-04	1,46-04	2,08-04
770	VC	2,62-05	3,41-05	7,42-05	1,62-04	3,09-04	5,22-04	8,36-04	1,30-03	1,88-03	2,68-03
770	VB	1,86-06	2,42-06	5,27-06	1,15-05	2,19-05	3,70-05	5,93-05	9,26-05	1,34-04	1,91-04
780	VC	2,44-05	3,16-05	6,83-05	1,48-04	2,82-04	4,77-04	7,62-04	1,19-03	1,72-03	2,46-03
780	VB	1,74-06	2,25-06	4,86-06	1,06-05	2,01-05	3,40-05	5,42-05	8,49-05	1,22-04	1,75-04
790	VC	2,27-05	2,94-05	6,31-05	1,36-04	2,58-04	4,37-04	6,96-04	1,09-03	1,57-03	2,25-03
790	VB	1,62-06	2,10-06	4,50-06	9,70-06	1,84-05	3,12-05	4,96-05	7,79-05	1,12-04	1,61-04
800	VC	2,12-05	2,74-05	5,87-05	1,25-04	2,36-04	4,01-04	6,35-04	1,00-03	1,44-03	2,07-03
800	VB	1,52-06	1,96-06	4,17-06	8,93-06	1,69-05	2,87-05	4,54-05	7,15-05	1,03-04	1,48-04
810	VC	1,98-05	2,55-05	5,40-05	1,15-04	2,16-04	3,68-04	5,80-04	9,16-04	1,32-03	1,89-03
810	VB	1,42-06	1,83-06	3,87-06	8,22-06	1,55-05	2,64-05	4,15-05	6,55-05	9,44-05	1,36-04
820	VC	1,85-05	2,38-05	5,01-05	1,06-04	1,98-04	3,38-04	5,30-04	8,39-04	1,21-03	1,74-03
820	VB	1,33-06	1,71-06	3,60-06	7,59-06	1,42-05	2,43-05	4,85-05	6,02-05	8,67-05	1,25-04
830	VC	1,74-05	2,23-05	4,65-05	9,75-05	1,82-04	3,11-04	3,80-04	7,69-04	1,11-03	1,59-03
830	VB	1,25-06	1,61-06	3,34-06	7,01-06	1,31-05	2,23-05	3,48-05	5,53-05	7,95-05	1,14-04
840	VC	1,63-05	2,09-05	4,33-05	9,00-05	1,67-04	2,85-04	4,43-04	7,05-04	1,01-03	1,46-03
840	VB	1,18-06	1,50-06	3,12-06	6,49-06	1,21-05	2,05-05	3,13-05	5,08-05	7,30-05	1,05-04
850	VC	1,53-05	1,95-05	4,03-05	8,31-05	1,54-04	2,63-04	4,06-04	6,46-04	9,29-04	1,34-03
850	VB	1,10-06	1,41-06	2,91-06	6,01-06	1,11-05	1,90-05	2,93-05	4,66-05	6,70-05	9,66-05
860	VC	1,44-05	1,83-05	3,76-05	7,69-05	1,42-04	2,42-04	3,71-04	5,92-04	8,51-04	1,23-03
860	VB	1,04-06	1,33-06	2,72-06	5,57-06	1,03-05	1,75-05	2,69-05	4,24-05	6,16-05	8,88-05

Высота, км	Затраги	Фиксированный уровень солнечной активности $F_{10} \cdot 10^{-22}$ ВТ(мг·Гн)									
		65	75	100	125	150	175	200	225	250	275
870	VC	1.35-05	1.72-05	3.51-05	7.12-05	1.31-04	2.23-04	3.40-04	5.43-04	7.80-04	1.13-03
870	VB	9.85-07	1.25-06	2.54-06	5.16-06	9.47-06	1.62-05	2.47-05	3.94-05	5.66-05	8.17-05
880	VC	1.27-05	1.62-05	3.27-05	6.60-05	1.20-04	2.06-04	3.12-04	4.99-04	7.15-04	1.03-03
880	VB	9.26-07	1.18-06	2.38-06	4.79-06	8.75-06	1.49-05	2.26-05	3.62-05	5.20-05	7.51-05
890	VC	1.20-05	1.53-05	3.06-05	6.12-05	1.11-04	1.90-04	2.86-04	4.58-04	6.56-04	9.49-04
890	VB	8.79-07	1.11-06	2.23-06	4.45-06	8.09-06	1.38-05	2.08-05	3.33-05	4.78-05	6.91-05
900	VC	1.13-05	1.44-05	2.87-05	5.68-05	1.03-04	1.75-04	2.62-04	4.20-04	6.02-04	8.71-04
900	VB	8.24-07	1.05-06	2.09-06	4.15-06	7.49-06	1.28-05	1.91-05	3.07-05	4.39-05	6.35-05
910	VC	1.07-05	1.36-05	2.69-05	5.28-05	9.49-05	1.62-04	2.40-04	3.86-04	5.52-04	7.99-04
910	VB	7.83-07	9.95-07	1.96-06	3.87-06	6.94-06	1.18-05	1.76-05	2.82-05	4.04-05	5.84-05
920	VC	1.01-05	1.28-05	2.52-05	4.91-05	8.78-05	1.50-04	2.21-04	3.54-04	5.07-04	7.34-04
920	VB	7.39-07	9.43-07	1.85-06	3.60-06	6.43-06	1.10-05	1.62-05	2.60-05	3.71-05	5.38-05
930	VC	9.53-06	1.21-05	2.37-05	4.57-05	8.12-05	1.38-04	2.03-04	3.26-04	4.65-04	6.74-04
930	VB	7.02-07	8.88-07	1.74-06	3.36-06	5.95-06	1.02-05	1.49-05	2.39-05	3.41-05	4.95-05
940	VC	9.01-05	1.14-05	2.22-05	4.26-05	7.52-05	1.28-04	1.85-04	2.99-04	4.27-04	6.19-04
940	VB	6.64-07	8.46-07	1.64-06	3.14-06	5.53-06	9.42-06	1.37-05	2.20-05	3.14-05	4.55-05
950	VC	8.24-06	1.08-05	2.09-05	3.97-05	6.97-05	1.19-04	1.71-04	2.75-04	3.92-04	5.69-04
950	VB	6.31-07	8.03-07	1.54-06	2.93-06	5.14-06	8.74-06	1.26-05	2.03-05	2.89-05	4.19-05
960	VC	8.08-05	1.02-05	1.97-05	3.70-05	6.46-05	1.10-04	1.57-04	2.53-04	3.60-04	5.22-04
960	VB	6.01-07	7.60-07	1.45-06	2.74-06	4.78-06	8.12-06	1.16-05	1.67-05	2.66-05	3.85-05
970	VC	7.65-06	9.71-06	1.85-05	3.46-05	6.00-05	1.02-04	1.45-04	2.33-04	3.31-04	4.80-04
970	VB	5.67-07	7.17-07	1.37-06	2.56-06	4.44-06	7.53-05	1.07-05	1.72-05	2.45-05	3.55-05
980	VC	7.26-06	9.21-06	1.74-05	3.23-05	5.57-05	9.44-05	1.33-04	2.14-04	3.04-04	4.41-04
980	VB	5.40-07	6.88-07	1.30-06	2.40-06	4.13-06	7.00-06	9.85-06	1.59-05	2.25-05	3.27-05
990	VC	6.89-06	8.73-06	1.65-05	3.02-05	5.17-05	8.76-05	1.22-04	1.97-04	2.79-04	4.05-04
990	VB	5.15-07	6.53-07	1.22-06	2.25-06	3.84-06	6.51-06	9.10-06	1.46-05	2.08-05	3.01-05
1000	VC	6.54-06	8.29-06	1.55-05	2.83-05	4.81-05	8.13-05	1.13-04	1.81-04	2.57-04	3.73-04
1000	VB	4.90-07	6.21-07	1.16-06	2.11-06	3.59-06	6.03-06	8.39-06	1.35-05	1.91-05	2.77-05
1010	VC	6.21-06	7.88-06	1.47-05	2.65-05	4.47-05	7.55-05	1.04-04	1.67-04	2.36-04	3.42-04
1010	VB	4.66-07	5.91-07	1.09-06	1.98-06	3.34-06	5.64-06	7.74-06	1.24-05	1.76-05	2.56-05
1020	VC	5.90-06	7.49-06	1.38-05	2.48-05	4.16-05	7.02-05	9.56-05	1.54-04	2.17-04	3.15-04
1020	VB	4.39-07	5.62-07	1.04-06	1.85-06	3.12-06	5.25-06	7.15-06	1.15-05	1.62-05	2.35-05
1030	VC	5.61-06	7.13-06	1.31-05	2.32-05	3.88-05	6.52-05	8.81-05	1.41-04	2.00-04	2.90-04
1030	VB	4.24-07	5.35-07	9.85-07	1.75-06	2.91-06	4.83-06	6.60-05	1.06-05	1.50-05	2.17-05
1040	VC	5.34-06	6.78-06	1.24-05	2.18-05	3.61-05	6.07-05	8.12-05	1.30-04	1.81-04	2.66-04
1040	VB	4.04-07	5.15-07	9.31-07	1.64-06	2.71-06	4.55-06	6.10-06	9.78-06	1.38-05	2.00-05
1050	VC	5.08-06	6.46-06	1.17-05	2.01-05	3.37-05	5.64-05	7.49-05	1.20-04	1.69-04	2.45-04
1050	VB	3.85-07	4.90-07	8.81-07	1.54-06	2.54-06	4.25-06	5.64-06	9.03-06	1.27-05	1.81-05
1060	VC	4.84-06	6.15-06	1.11-05	1.92-05	3.14-05	5.25-05	6.91-05	1.11-04	1.55-04	2.25-04
1060	VB	3.64-07	4.66-07	8.35-07	1.44-06	2.37-06	3.96-06	5.21-06	8.34-06	1.17-05	1.70-05
1070	VC	4.61-06	5.86-06	1.05-05	1.80-05	2.93-05	4.83-05	6.38-05	1.02-04	1.43-04	2.07-04
1070	VB	3.53-07	4.44-07	7.92-07	1.36-06	2.22-06	3.69-06	4.82-06	7.71-06	1.08-05	1.57-05
1080	VC	4.40-06	5.59-06	9.96-05	1.69-05	2.73-05	4.56-05	5.89-05	9.40-05	1.32-04	1.91-04
1080	VB	3.33-07	4.29-07	7.55-07	1.28-06	2.07-06	3.45-06	4.46-06	7.12-06	9.98-06	1.44-05
1090	VC	4.20-05	5.33-05	9.45-05	1.59-05	2.55-05	4.25-05	5.44-05	8.67-05	1.21-04	1.76-04
1090	VB	3.24-07	4.09-07	7.17-07	1.21-06	1.94-06	3.22-06	4.13-06	6.58-06	9.21-06	1.33-05
1100	VC	4.00-05	5.09-05	8.97-06	1.50-05	2.39-05	3.96-05	5.03-05	8.00-05	1.12-04	1.62-04
1100	VB	3.08-07	3.85-07	6.88-07	1.14-06	1.82-06	3.01-06	3.82-06	6.08-06	8.50-06	1.23-05
1110	VC	3.82-06	4.86-06	8.51-06	1.41-05	2.23-05	3.69-05	4.64-05	7.38-05	1.03-04	1.49-04
1110	VB	2.89-07	3.75-07	6.53-07	1.08-06	1.70-06	2.82-06	3.54-06	5.62-06	7.81-06	1.13-05
1120	VC	3.64-06	4.64-06	8.08-06	1.33-05	2.09-05	3.45-05	4.29-05	6.81-05	9.48-05	1.37-04
1120	VB	2.78-07	3.53-07	6.21-07	1.02-06	1.60-06	2.63-06	3.28-06	5.20-06	7.24-06	1.05-05
1130	VC	3.48-06	4.43-06	7.68-06	1.25-05	1.95-05	3.22-05	3.97-05	6.29-05	8.74-05	1.26-04
1130	VB	2.68-07	3.42-07	5.91-07	9.59-07	1.49-06	2.46-06	3.04-06	4.81-06	6.68-06	9.64-06
1140	VC	3.33-06	4.24-06	7.30-06	1.18-05	1.83-05	3.01-05	3.67-05	5.80-05	8.05-05	1.16-04
1140	VB	2.57-07	3.28-07	5.57-07	9.04-07	1.40-06	2.30-06	2.82-06	4.45-06	6.17-06	8.90-06
1150	VC	3.18-06	4.06-06	6.94-06	1.11-05	1.71-05	2.81-05	3.40-05	5.35-05	7.42-05	1.07-04
1150	VB	2.46-07	3.13-07	5.35-07	8.59-07	1.32-06	2.16-06	2.61-06	4.12-06	5.70-06	8.22-06
1160	VC	3.04-06	3.88-06	6.60-06	1.05-05	1.60-05	2.62-05	3.14-05	4.95-05	6.85-05	9.85-05
1160	VB	2.37-07	3.02-07	5.10-07	8.08-07	1.23-06	2.02-06	2.42-06	3.81-06	5.27-06	7.58-06
1170	VC	2.91-05	3.71-06	6.28-06	9.90-06	1.50-05	2.45-05	2.91-05	4.57-05	6.31-05	9.08-05
1170	VB	2.27-07	2.89-07	4.82-07	7.68-07	1.16-06	1.90-06	2.25-06	3.52-06	4.87-06	7.00-06
1180	VC	2.78-06	3.55-06	5.98-06	9.35-06	1.41-05	2.29-05	2.70-05	4.23-05	5.82-05	8.37-05
1180	VB	2.17-07	2.78-07	4.60-07	7.22-07	1.09-06	1.77-06	2.08-06	3.26-06	4.50-06	6.47-06

Высота, км	Загрязн.	Фиксированный уровень солнечной активности $F_{10} \cdot 10^{-22}$ Вт/(м <sup>2</sup> ·Гц)									
		65	75	100	125	150	175	200	225	250	275
1190	VC	2.67-06	3.40-06	5.70-06	8.83-06	1.32-05	2.15-05	2.50-05	3.91-05	5.37-05	7.71-05
1190	VB	2.03-07	2.68-07	4.39-07	6.88-07	1.02-06	1.66-06	1.93-06	3.02-06	4.15-06	5.97-06
1200	VC	2.55-06	3.26-06	5.43-06	8.35-06	1.24-05	2.01-05	2.31-05	3.61-05	4.95-05	7.11-05
1200	VB	1.98-07	2.57-07	4.24-07	6.48-07	9.65-07	1.55-06	1.80-06	2.83-06	3.84-06	5.51-06
1210	VC	2.44-06	3.13-06	5.18-06	7.89-06	1.16-05	1.88-05	2.14-05	3.34-05	4.57-05	6.55-05
1210	VB	1.93-07	2.46-07	4.03-07	6.10-07	9.01-07	1.46-06	1.67-06	2.59-06	3.55-06	5.09-06
1220	VC	2.34-06	3.00-06	4.93-06	7.46-06	1.09-05	1.76-05	1.99-05	3.09-05	4.22-05	6.04-05
1220	VB	1.82-07	2.37-07	3.85-07	5.81-07	8.51-07	1.37-06	1.55-06	2.40-06	3.29-06	4.70-06
1230	VC	2.24-06	2.87-06	4.71-06	7.05-06	1.03-05	1.65-05	1.84-05	2.86-05	3.89-05	5.57-05
1230	VB	1.77-07	2.27-07	3.69-07	5.51-07	8.03-07	1.28-06	1.44-06	2.23-06	3.04-06	4.35-06
1240	VC	2.15-06	2.76-06	4.50-06	6.68-06	9.64-06	1.55-05	1.71-05	2.64-05	3.60-05	5.14-05
1240	VB	1.71-07	2.17-07	3.53-07	5.24-07	7.55-07	1.21-06	1.34-06	2.06-06	2.81-06	4.01-06
1250	VC	2.06-06	2.64-06	4.29-06	6.33-06	9.07-06	1.45-05	1.59-05	2.44-05	3.32-05	4.74-05
1250	VB	1.61-07	2.11-07	3.38-07	4.95-07	7.12-07	1.14-06	1.24-06	1.92-06	2.60-06	3.71-06
1260	VC	1.98-06	2.54-06	4.09-06	5.99-06	8.52-06	1.36-05	1.47-05	2.26-05	3.07-05	4.37-05
1260	VB	1.57-07	2.03-07	3.24-07	4.71-07	6.69-07	1.07-06	1.16-06	1.78-06	2.41-06	3.43-06
1270	VC	1.90-06	2.44-06	3.91-06	5.67-06	8.02-06	1.27-05	1.37-05	2.09-05	2.83-05	4.03-05
1270	VB	1.51-07	1.93-07	3.13-07	4.50-07	6.31-07	1.01-06	1.08-06	1.65-06	2.23-06	3.17-06
1280	VC	1.82-06	2.34-06	3.74-06	5.37-06	7.55-06	1.20-05	1.27-05	1.94-05	2.62-05	3.72-05
1280	VB	1.46-07	1.82-07	2.94-07	4.29-07	5.95-07	9.43-07	1.00-06	1.53-06	2.06-06	2.93-06
1290	VC	1.75-06	2.25-06	3.58-06	5.09-06	7.10-06	1.12-05	1.18-05	1.80-05	2.42-05	3.43-05
1290	VB	1.42-07	1.82-07	2.84-07	4.09-07	5.62-07	8.88-07	9.31-07	1.42-06	1.91-06	2.71-06
1300	VC	1.68-06	2.16-06	3.42-06	4.83-06	6.69-06	1.05-05	1.10-05	1.66-05	2.23-05	3.16-05
1300	VB	1.36-07	1.71-07	2.68-07	3.85-07	5.30-07	8.35-07	8.70-07	1.32-06	1.77-06	2.51-06
1310	VC	1.61-06	2.08-06	3.26-06	4.58-06	6.29-06	9.90-06	1.02-05	1.54-05	2.07-05	2.92-05
1310	VB	1.31-07	1.65-07	2.57-07	3.64-07	5.06-07	7.83-07	8.08-07	1.22-06	1.64-06	2.31-06
1320	VC	1.55-06	2.00-06	3.13-06	4.35-06	5.93-06	9.30-06	9.47-06	1.43-05	1.91-05	2.70-05
1320	VB	1.26-07	1.61-07	2.46-07	3.42-07	4.71-07	7.39-07	7.49-07	1.14-06	1.52-06	2.14-06
1330	VC	1.49-06	1.93-06	2.99-06	4.13-06	5.59-06	8.74-06	8.81-06	1.32-05	1.77-05	2.49-05
1330	VB	1.20-07	1.57-07	2.37-07	3.33-07	4.50-07	6.97-07	7.02-07	1.05-06	1.40-06	1.98-06
1340	VC	1.43-06	1.85-06	2.85-06	3.92-06	5.27-06	8.21-06	8.19-06	1.23-05	1.63-05	2.30-05
1340	VB	1.20-07	1.51-07	2.33-07	3.13-07	4.19-07	6.53-07	6.53-07	9.74-07	1.31-06	1.83-06
1350	VC	1.38-06	1.78-06	2.74-06	3.72-06	4.97-06	7.72-06	7.62-06	1.14-05	1.51-05	2.12-05
1350	VB	1.07-07	1.46-07	2.22-07	3.02-07	3.99-07	6.21-07	6.10-07	9.10-07	1.21-06	1.69-06
1360	VC	1.32-06	1.71-06	2.62-06	3.54-06	4.69-06	7.26-06	7.09-06	1.05-05	1.40-05	1.96-05
1360	VB	1.07-07	1.42-07	2.17-07	2.84-07	3.75-07	5.86-07	5.67-07	8.46-07	1.12-06	1.51-06
1370	VC	1.27-06	1.65-06	2.52-06	3.36-06	4.42-06	6.83-06	6.60-06	9.77-06	1.29-05	1.87-05
1370	VB	1.07-07	1.36-07	2.03-07	2.68-07	3.53-07	5.46-07	5.30-07	7.83-07	1.04-06	1.45-06
1383	VC	1.22-06	1.59-06	2.41-06	3.20-06	4.17-06	6.43-06	6.14-06	9.07-06	1.20-05	1.67-05
1383	VB	9.63-08	1.31-07	1.93-07	2.57-07	3.38-07	5.15-07	4.95-07	7.28-07	9.65-07	1.34-06
1390	VC	1.18-06	1.53-06	2.31-06	3.04-06	3.94-06	6.05-06	5.72-06	8.41-05	1.11-05	1.54-05
1390	VB	9.63-08	1.26-07	1.87-07	2.46-07	3.24-07	4.90-07	4.69-07	7.77-07	8.88-07	1.24-06
1400	VC	1.14-06	1.48-06	2.21-06	2.89-06	3.72-06	5.70-06	5.33-06	7.80-05	1.02-05	1.43-05
1400	VB	9.63-08	1.20-07	1.82-07	2.37-07	3.02-07	4.60-07	4.29-07	6.31-07	8.24-07	1.15-06
1410	VC	1.09-06	1.42-06	2.12-06	2.75-06	3.52-06	5.36-06	4.97-06	7.24-06	9.48-06	1.32-05
1410	VB	8.56-08	1.20-07	1.71-07	2.27-07	2.89-07	4.33-07	4.04-07	5.91-07	7.73-07	1.07-06
1420	VC	1.05-06	1.37-06	2.03-06	2.61-06	3.32-06	5.05-06	4.62-06	6.72-06	8.78-06	1.22-05
1420	VB	8.56-08	1.15-07	1.66-07	2.17-07	2.68-07	4.09-07	3.75-07	5.46-07	7.12-07	9.85-07
1430	VC	1.01-06	1.32-06	1.95-06	2.49-06	3.14-06	4.77-06	4.32-06	6.24-06	8.14-06	1.13-05
1430	VB	8.56-08	1.07-07	1.61-07	2.03-07	2.57-07	3.85-07	3.53-07	5.10-07	6.64-07	9.15-07
1440	VC	9.74-07	1.27-06	1.87-06	2.37-06	2.96-06	4.49-06	4.02-06	5.79-06	7.53-06	1.04-05
1440	VB	8.03-08	1.07-07	1.51-07	1.93-07	2.46-07	3.64-07	3.28-07	4.71-07	6.10-07	8.46-07
1450	VC	9.43-07	1.23-06	1.80-06	2.26-06	2.80-06	4.23-06	3.75-06	5.38-06	6.98-06	9.62-06
1450	VB	7.49-08	1.02-07	1.51-07	1.82-07	2.33-07	3.42-07	3.08-07	4.39-07	5.67-07	7.83-07
1460	VC	9.04-07	1.18-06	1.72-06	2.15-06	2.66-06	3.99-06	3.50-06	5.00-06	6.47-06	8.89-06
1460	VB	7.49-08	9.63-08	1.42-07	1.77-07	2.17-07	3.28-07	2.89-07	4.09-07	5.24-07	7.28-07
1470	VC	8.74-07	1.15-06	1.66-06	2.05-06	2.52-06	3.76-06	3.26-06	4.65-06	5.99-06	8.23-06
1470	VB	7.49-08	9.63-08	1.42-07	1.71-07	2.03-07	3.13-07	2.68-07	3.80-07	4.95-07	6.77-07
1480	VC	8.40-07	1.10-06	1.59-06	1.95-06	2.38-06	3.55-06	3.04-06	4.32-06	5.56-06	7.61-06
1480	VB	6.96-08	9.10-08	1.31-07	1.61-07	1.93-07	2.89-07	2.52-07	3.53-07	4.55-07	6.21-07
1490	VC	8.13-07	1.07-06	1.53-06	1.86-06	2.25-06	3.35-06	2.84-06	4.01-06	5.15-06	7.03-06
1490	VB	6.42-08	8.56-08	1.31-07	1.51-07	1.82-07	2.78-07	2.37-07	3.33-07	4.24-07	5.81-07
1500	VC	7.83-07	1.03-06	1.47-06	1.78-06	2.13-06	3.16-06	2.66-06	3.72-06	4.78-06	6.51-06
1500	VB	6.42-08	8.56-08	1.26-07	1.51-07	1.77-07	2.57-07	2.22-07	3.13-07	3.99-07	5.35-07



Максимальные затраты характеристической скорости за сутки (VC) и за виток (VB), м/с

Высота, км	Затраты	Фиксируемый уровень солнечной активности $F_{10.7}$ , $10^{-22}$ Вт/(м <sup>2</sup> ·Гц)												
		65	75	100	125	150	175	200	225	250	275			
120	VC	1.97+02	1.97+02	1.97+02	1.97+02	1.97+02	1.97+02	1.97+02	1.97+02	1.97+02	1.97+02	1.97+02	1.97+02	1.97+02
120	VB	1.17-01	1.17+01	1.17+01	1.17+01	1.17+01	1.17+01	1.17+01	1.17+01	1.17+01	1.17+01	1.17+01	1.17+01	1.17+01
125	VC	1.05-02	1.05+02	1.09+02	1.06+02	1.06+02	1.06+02	1.08+02	1.08+02	1.08+02	1.08+02	1.08+02	1.08+02	1.08+02
125	VB	6.36+00	6.39+00	6.59+00	6.45+00	6.41+00	6.43+00	6.52+00	6.54+00	6.54+00	6.54+00	6.54+00	6.54+00	6.54+00
130	VC	6.58+01	6.64+01	6.93+01	6.84+01	6.85+01	6.92+01	7.02+01	7.08+01	7.08+01	7.11+01	7.11+01	7.15+01	7.15+01
130	VB	4.01+00	4.05+00	4.22+00	4.18+00	4.18+00	4.22+00	4.28+00	4.32+00	4.32+00	4.33+00	4.36+00	4.36+00	4.36+00
135	VC	4.44+01	4.51+01	4.74+01	4.76+01	4.80+01	4.88+01	4.95+01	5.02+01	5.05+01	5.06+01	5.11+01	5.11+01	5.11+01
135	VB	2.72+00	2.77+00	2.90+00	2.92+00	2.94+00	2.99+00	3.03+00	3.08+00	3.10+00	3.10+00	3.13+00	3.13+00	3.13+00
140	VC	3.15+01	3.22+01	3.39+01	3.47+01	3.52+01	3.61+01	3.65+01	3.73+01	3.77+01	3.77+01	3.82+01	3.82+01	3.82+01
140	VB	1.94+00	1.98+00	2.08+00	2.13+00	2.17+00	2.22+00	2.25+00	2.29+00	2.32+00	2.32+00	2.35+00	2.35+00	2.35+00
145	VC	2.31+01	2.37+01	2.50+01	2.61+01	2.67+01	2.75+01	2.78+01	2.86+01	2.90+01	2.90+01	2.95+01	2.95+01	2.95+01
145	VB	1.43+00	1.46+00	1.54+00	1.61+00	1.65+00	1.70+00	1.71+00	1.76+00	1.78+00	1.78+00	1.81+00	1.81+00	1.81+00
150	VC	1.74+01	1.80+01	1.90+01	2.01+01	2.08+01	2.15+01	2.17+01	2.24+01	2.28+01	2.28+01	2.33+01	2.33+01	2.33+01
150	VB	1.07+00	1.11+00	1.17+00	1.24+00	1.28+00	1.33+00	1.34+00	1.38+00	1.41+00	1.41+00	1.44+00	1.44+00	1.44+00
155	VC	1.33+01	1.39+01	1.46+01	1.53+01	1.64+01	1.71+01	1.72+01	1.79+01	1.82+01	1.82+01	1.87+01	1.87+01	1.87+01
155	VB	8.26-01	8.58-01	9.06-01	9.80-01	1.02+00	1.06+00	1.07+00	1.11+00	1.13+00	1.13+00	1.16+00	1.16+00	1.16+00
160	VC	1.04+01	1.09+01	1.15+01	1.26+01	1.32+01	1.38+01	1.39+01	1.45+01	1.48+01	1.48+01	1.52+01	1.52+01	1.52+01
160	VB	6.46-01	6.74-01	7.12-01	7.83-01	8.18-01	8.57-01	8.61-01	8.95-01	9.18-01	9.18-01	9.43-01	9.43-01	9.43-01
165	VC	8.24+00	8.64+00	9.13+00	1.02+01	1.07+01	1.13+01	1.13+01	1.19+01	1.22+01	1.22+01	1.25+01	1.25+01	1.25+01
165	VB	5.11-01	5.36-01	5.67-01	6.34-01	6.67-01	7.02-01	7.04-01	7.36-01	7.56-01	7.56-01	7.78+01	7.78+01	7.78+01
170	VC	6.59+00	6.94+00	7.33+00	8.35+00	8.83+00	9.35+00	9.35+00	9.82+00	1.01+01	1.01+01	1.04+01	1.04+01	1.04+01
170	VB	4.10-01	4.32-01	4.56-01	5.19-01	5.49-01	5.81-01	5.81-01	6.10-01	6.28-01	6.28-01	6.49-01	6.49-01	6.49-01
175	VC	5.33+00	5.64+00	5.95+00	6.88+00	7.32+00	7.79+00	7.77+00	8.20+00	8.47+00	8.47+00	8.77+00	8.77+00	8.77+00
175	VB	3.32-01	3.51-01	3.71-01	4.29-01	4.56-01	4.85-01	4.84-01	5.10-01	5.27-01	5.27-01	5.46-01	5.46-01	5.46-01
180	VC	3.56+00	3.89+00	4.37+00	5.26+00	5.79+00	6.21+00	6.63+00	7.03+00	7.30+00	7.30+00	7.60+00	7.60+00	7.60+00
180	VB	2.22-01	2.43-01	2.73-01	3.28-01	3.61-01	3.87-01	4.13-01	4.38-01	4.55-01	4.55-01	4.74-01	4.74-01	4.74-01
185	VC	3.04+00	3.32+00	3.77+00	4.57+00	4.99+00	5.38+00	5.72+00	6.09+00	6.30+00	6.30+00	6.58+00	6.58+00	6.58+00
185	VB	1.90-01	2.07-01	2.35-01	2.85-01	3.11-01	3.36-01	3.57-01	3.80-01	3.93-01	3.93-01	4.11-01	4.11-01	4.11-01
190	VC	2.61+00	2.85+00	3.25+00	3.97+00	4.32+00	4.68+00	4.97+00	5.31+00	5.48+00	5.48+00	5.74+00	5.74+00	5.74+00
190	VB	1.63-01	1.78-01	2.03-01	2.48-01	2.70-01	2.93-01	3.11-01	3.32-01	3.43-01	3.43-01	3.59-01	3.59-01	3.59-01
195	VC	2.24+00	2.45+00	2.82+00	3.47+00	3.75+00	4.09+00	4.34+00	4.69+00	4.80+00	4.80+00	5.04+00	5.04+00	5.04+00
195	VB	1.40-01	1.53-01	1.76-01	2.17-01	2.35-01	2.56-01	2.72-01	2.91-01	3.00-01	3.00-01	3.15-01	3.15-01	3.15-01
200	VC	1.93+00	2.11+00	2.45+00	3.03+00	3.28+00	3.59+00	3.81+00	4.11+00	4.23+00	4.23+00	4.46+00	4.46+00	4.46+00
200	VB	1.21-01	1.32-01	1.53-01	1.90-01	2.05-01	2.25-01	2.39-01	2.57-01	2.65-01	2.65-01	2.79-01	2.79-01	2.79-01
205	VC	1.66+00	1.82+00	2.13+00	2.66+00	2.87+00	3.16+00	3.35+00	3.63+00	3.75+00	3.75+00	3.96+00	3.96+00	3.96+00
205	VB	1.04-01	1.14-01	1.34-01	1.67-01	1.80-01	1.98-01	2.10-01	2.28-01	2.35-01	2.35-01	2.48-01	2.48-01	2.48-01
210	VC	1.44+00	1.58+00	1.88+00	2.34+00	2.52+00	2.80+00	2.97+00	3.23+00	3.33+00	3.33+00	3.53+00	3.53+00	3.53+00
210	VB	9.03-02	9.90-02	1.17-01	1.47-01	1.58-01	1.76-01	1.83-01	2.03-01	2.09-01	2.09-01	2.22-01	2.22-01	2.22-01
215	VC	1.25+00	1.37+00	1.63+00	2.06+00	2.22+00	2.48+00	2.63+00	2.88+00	2.97+00	2.97+00	3.16+00	3.16+00	3.16+00
215	VB	7.83-02	8.61-02	1.02-01	1.30-01	1.40-01	1.56-01	1.66-01	1.81-01	1.87-01	1.87-01	1.99-01	1.99-01	1.99-01
220	VC	1.08+00	1.19+00	1.43+00	1.82+00	1.97+00	2.20+00	2.34+00	2.57+00	2.66+00	2.66+00	2.84+00	2.84+00	2.84+00
220	VB	6.80-02	7.50-02	9.00-02	1.15-01	1.24-01	1.39-01	1.48-01	1.62-01	1.68-01	1.68-01	1.79-01	1.79-01	1.79-01
225	VC	9.40-01	1.04+00	1.26+00	1.61+00	1.74+00	1.97+00	2.09+00	2.31+00	2.39+00	2.39+00	2.56+00	2.56+00	2.56+00
225	VB	5.92-02	6.55-02	7.92-02	1.02-01	1.10-01	1.24-01	1.32-01	1.45-01	1.51-01	1.51-01	1.62-01	1.62-01	1.62-01
230	VC	8.19-01	9.08-01	1.11+00	1.43+00	1.55+00	1.76+00	1.88+00	2.07+00	2.16+00	2.16+00	2.32+00	2.32+00	2.32+00
230	VB	5.17-02	5.73-02	6.98-02	9.04-02	9.78-02	1.11-01	1.18-01	1.31-01	1.36-01	1.36-01	1.46-01	1.46-01	1.46-01
235	VC	7.15-01	7.96-01	9.77-01	1.27+00	1.38+00	1.57+00	1.68+00	1.87+00	1.95+00	1.95+00	2.10+00	2.10+00	2.10+00
235	VB	4.51-02	5.02-02	6.17-02	8.04-02	8.73-02	9.94-02	1.06-01	1.18-01	1.23-01	1.23-01	1.33-01	1.33-01	1.33-01
240	VC	6.25-01	6.97-01	8.64-01	1.13+00	1.23+00	1.41+00	1.52+00	1.69+00	1.77+00	1.77+00	1.91+00	1.91+00	1.91+00
240	VB	3.95-02	4.41-02	5.46-02	7.17-02	7.80-02	8.94-02	9.58-02	1.07-01	1.12-01	1.12-01	1.21-01	1.21-01	1.21-01
245	VC	5.47-01	6.13-01	7.65-01	1.01+00	1.10+00	1.27+00	1.37+00	1.53+00	1.61+00	1.61+00	1.74+00	1.74+00	1.74+00
245	VB	3.46-02	3.88-02	4.85-02	6.40-02	6.99-02	8.05-02	8.65-02	9.70-02	1.02-01	1.02-01	1.10-01	1.10-01	1.10-01
250	VC	4.80-01	5.39-01	6.79-01	9.04-01	9.91-01	1.15+00	1.24+00	1.39+00	1.46+00	1.46+00	1.59+00	1.59+00	1.59+00
250	VB	3.04-02	3.42-02	4.31-02	5.73-02	6.28-02	7.27-02	7.83-02	8.81-02	9.28-02	9.28-02	1.01-01	1.01-01	1.01-01
255	VC	4.21-01	4.76-01	6.04-01	8.09-01	8.90-01	1.04+00	1.12+00	1.26+00	1.34+00	1.34+00	1.46+00	1.46+00	1.46+00
255	VB	2.67-02	3.02-02	3.83-02	5.13-02	5.65-02	6.57-02	7.10-02	8.02-02	8.47-02	8.47-02	9.25-02	9.25-02	9.25-02
260	VC	3.70-01	4.20-01	5.38-01	7.25-01	8.01-01	9.38-01	1.02+00	1.15+00	1.22+00	1.22+00	1.34+00	1.34+00	1.34+00
260	VB	2.35-02	2.67-02	3.41-02	4.60-02	5.09-02	5.96-02	6.45-02	7.32-02	7.75-02	7.75-02	8.49-02	8.49-02	8.49-02
265	VC	3.26-01	3.72-01	4.79-01	6.51-01	7.23-01	8.50-01	9.23-01	1.05+00	1.12+00	1.12+00	1.23+00	1.23+00	1.23+00
265	VB	2.08-02	2.36-02	3.05-02	4.14-02	4.60-02	5.41-02	5.87-02	6.69-02	7.11-02	7.11-02	7.81-02	7.81-02	7.81-02

Высота, км	Затраги	Фиксированный уровень солнечной активности $F_{10.7}$ , $10^{-22}$ Вт/(м <sup>2</sup> ·Гц)									
		65	75	100	125	150	175	200	225	250	275
270	VC	2.88-01	3.29-01	4.28-01	5.85-01	6.53-01	7.72-01	8.41-01	9.62-01	1.03+00	1.13+00
270	VB	1.83-02	2.10-02	2.72-02	3.72-02	4.16-02	4.91-02	5.35-02	6.12-02	6.53-02	7.20-02
275	VC	2.54-01	2.92-01	3.83-01	5.26-01	5.90-01	7.02-01	7.67-01	8.81-01	9.43-01	1.04+00
275	VB	1.62-02	1.86-02	2.44-02	3.35-02	3.76-02	4.47-02	4.89-02	5.61-02	6.01-02	6.64-02
280	VC	2.25-01	2.60-01	3.43-01	4.74-01	5.35-01	6.39-01	7.00-01	8.08-01	8.67-01	9.62-01
280	VB	1.43-02	1.66-02	2.19-02	3.03-02	3.41-02	4.08-02	4.47-02	5.15-02	5.54-02	6.14-02
285	VC	1.99-01	2.31-01	3.07-01	4.28-01	4.85-01	5.83-01	6.40-01	7.42-01	7.99-01	8.89-01
285	VB	1.27-02	1.48-02	1.96-02	2.73-02	3.10-02	3.72-02	4.09-02	4.74-02	5.11-02	5.68-02
290	VC	1.76-01	2.06-01	2.76-01	3.87-01	4.41-01	5.32-01	5.87-01	6.82-01	7.38-01	8.23-01
290	VB	1.13-02	1.32-02	1.76-02	2.47-02	2.82-02	3.40-02	3.75-02	4.36-02	4.72-02	5.26-02
295	VC	1.56-01	1.84-01	2.48-01	3.50-01	4.01-01	4.85-01	5.38-01	6.28-01	6.82-01	7.63-01
295	VB	1.00-02	1.18-02	1.59-02	2.24-02	2.57-02	3.11-02	3.44-02	4.02-02	4.37-02	4.88-02
300	VC	1.39-01	1.64-01	2.23-01	3.17-01	3.65-01	4.45-01	4.94-01	5.79-01	6.31-01	7.08-01
300	VB	8.90-03	1.05-02	1.43-02	2.03-02	2.34-02	2.85-02	3.17-02	3.71-02	4.04-02	4.54-02
310	VC	1.10-01	1.31-01	1.81-01	2.60-01	3.04-01	3.74-01	4.18-01	4.94-01	5.42-01	6.11-01
310	VB	7.06-03	8.43-03	1.16-02	1.67-02	1.95-02	2.40-02	2.69-02	3.17-02	3.48-02	3.93-02
320	VC	8.74-02	1.05-01	1.48-01	2.15-01	2.54-01	3.16-01	3.55-01	4.23-01	4.67-01	5.30-01
320	VB	5.63-03	6.79-03	9.51-03	1.38-02	1.64-02	2.03-02	2.29-02	2.72-02	3.01-02	3.42-02
330	VC	6.97-02	8.52-02	1.21-01	1.78-01	2.14-01	2.68-01	3.03-01	3.64-01	4.05-01	4.62-01
330	VB	4.50-03	5.50-03	7.81-03	1.15-02	1.38-02	1.73-02	1.96-02	2.35-02	2.61-02	2.98-02
340	VC	5.59-02	6.90-02	9.95-02	1.48-01	1.80-01	2.28-01	2.60-01	3.14-01	3.52-01	4.04-01
340	VB	3.61-03	4.46-03	6.43-03	9.59-03	1.16-02	1.47-02	1.68-02	2.03-02	2.28-02	2.61-02
350	VC	4.49-02	5.61-02	8.21-02	1.24-01	1.52-01	1.95-01	2.23-01	2.72-01	3.07-01	3.54-01
350	VB	2.91-03	3.64-03	5.32-03	8.03-03	9.88-03	1.26-02	1.45-02	1.76-02	1.99-02	2.30-02
360	VC	3.62-02	4.58-02	6.79-02	1.04-01	1.29-01	1.67-01	1.93-01	2.36-01	2.69-01	3.12-01
360	VB	2.35-03	2.98-03	4.41-03	6.74-03	8.40-03	1.08-02	1.25-02	1.53-02	1.75-02	2.02-02
370	VC	2.93-02	3.75-02	5.64-02	8.71-02	1.10-01	1.43-01	1.67-01	2.06-01	2.35-01	2.75-01
370	VB	1.91-03	2.44-03	3.67-03	5.67-03	7.17-03	9.33-03	1.09-02	1.34-02	1.54-02	1.79-02
380	VC	2.38-02	3.08-02	4.70-02	7.34-02	9.41-02	1.23-01	1.45-01	1.80-01	2.08-01	2.43-01
380	VB	1.55-03	2.01-03	3.07-03	4.79-03	6.14-03	8.06-03	9.44-03	1.17-02	1.35-02	1.59-02
390	VC	1.94-02	2.54-02	3.93-02	6.20-02	8.06-02	1.07-01	1.26-01	1.57-01	1.83-01	2.16-01
390	VB	1.27-03	1.65-03	2.57-03	4.06-03	5.27-03	6.98-03	8.23-03	1.03-02	1.20-02	1.41-02
400	VC	1.58-02	2.10-02	3.29-02	5.25-02	6.93-02	9.25-02	1.10-01	1.38-01	1.62-01	1.92-01
400	VB	1.04-03	1.38-03	2.16-03	3.44-03	4.54-03	6.06-03	7.19-03	9.06-03	1.06-02	1.26-02
410	VC	1.29-02	1.74-02	2.76-02	4.46-02	5.97-02	8.03-02	9.59-02	1.22-01	1.44-01	1.71-01
410	VB	8.50-04	1.14-03	1.82-03	2.93-03	3.92-03	5.28-03	6.30-03	7.99-03	9.43-03	1.12-02
420	VC	1.06-02	1.45-02	2.33-02	3.80-02	5.15-02	6.99-02	8.41-02	1.07-01	1.28-01	1.52-01
420	VB	6.99-04	9.53-04	1.53-03	2.50-03	3.39-03	4.60-03	5.54-03	7.07-03	8.40-03	1.00-02
430	VC	8.74-03	1.21-02	1.96-02	3.24-02	4.46-02	6.10-02	7.39-02	9.49-02	1.14-01	1.36-01
430	VB	5.77-04	7.96-04	1.30-03	2.14-03	2.94-03	4.03-03	4.87-03	6.26-03	7.49-03	9.00-03
440	VC	7.21-03	1.01-02	1.66-02	2.77-02	3.87-02	5.33-02	6.50-02	8.40-02	1.01-01	1.22-01
440	VB	4.77-04	6.67-04	1.10-03	1.83-03	2.56-03	3.53-03	4.30-03	5.56-03	6.70-03	8.08-03
450	VC	5.96-03	8.44-03	1.41-02	2.37-02	3.36-02	4.67-02	5.73-02	7.46-02	9.05-02	1.10-01
450	VB	3.95-04	5.59-04	9.34-04	1.57-03	2.23-03	3.10-03	3.80-03	4.94-03	6.00-03	7.27-03
460	VC	4.94-03	7.08-03	1.20-02	2.04-02	2.93-02	4.10-02	5.07-02	6.63-02	8.10-02	9.85-02
460	VB	3.28-04	4.70-04	7.96-04	1.35-03	1.94-03	2.73-03	3.37-03	4.40-03	5.38-03	6.55-03
470	VC	4.10-03	5.95-03	1.02-02	1.75-02	2.55-02	3.61-02	4.48-02	5.91-02	7.27-02	8.89-02
470	VB	2.73-04	3.96-04	6.79-04	1.17-03	1.70-03	2.40-03	2.99-03	3.93-03	4.81-03	5.92-03
480	VC	3.41-03	5.02-03	8.70-03	1.51-02	2.23-02	3.18-02	3.98-02	5.27-02	6.53-02	8.02-02
480	VB	2.28-04	3.35-04	5.81-04	1.01-03	1.49-03	2.12-03	2.65-03	3.52-03	4.35-03	5.35-03
490	VC	2.84-03	4.24-03	7.44-03	1.30-02	1.96-02	2.81-02	3.53-02	4.71-02	5.87-02	7.24-02
490	VB	1.90-04	2.83-04	4.97-04	8.73-04	1.31-03	1.88-03	2.36-03	3.15-03	3.93-03	4.84-03
500	VC	2.38-03	3.59-03	6.37-03	1.13-02	1.72-02	2.48-02	3.14-02	4.21-02	5.29-02	6.55-02
500	VB	1.59-04	2.40-04	4.27-04	7.56-04	1.15-03	1.66-03	2.11-03	2.82-03	3.54-03	4.39-03
510	VC	1.99-03	3.04-03	5.47-03	9.78-03	1.51-02	2.20-02	2.80-02	3.78-02	4.77-02	5.94-02
510	VB	1.34-04	2.04-04	3.67-04	6.57-04	1.01-03	1.47-03	1.88-03	2.54-03	3.20-03	3.99-03
520	VC	1.67-03	2.58-03	4.70-03	8.49-03	1.33-02	1.95-02	2.50-02	3.39-02	4.31-02	5.39-02
520	VB	1.12-04	1.74-04	3.16-04	5.71-04	8.93-04	1.31-03	1.68-03	2.28-03	2.90-03	3.63-03
530	VC	1.40-03	2.20-03	4.04-03	7.38-03	1.17-02	1.73-02	2.23-02	3.05-02	3.90-02	4.89-02
530	VB	9.45-05	1.48-04	2.73-04	4.97-04	7.89-04	1.17-03	1.51-03	2.05-03	2.63-03	3.30-03
540	VC	1.18-03	1.87-03	3.49-03	6.42-03	1.03-02	1.54-02	2.00-02	2.74-02	3.53-02	4.45-02
540	VB	7.97-05	1.27-04	2.36-04	4.34-04	6.98-04	1.04-03	1.35-03	1.85-03	2.39-03	3.01-03
550	VC	9.93-04	1.60-03	3.01-03	5.60-03	9.12-03	1.37-02	1.79-02	2.47-02	3.20-02	4.05-02
550	VB	6.73-05	1.08-04	2.04-04	3.79-04	6.18-04	9.27-04	1.21-03	1.67-03	2.17-03	2.75-03

Продолжение табл. 7

Высота, км	Загрязн.	Фиксированный уровень солнечной активности $F_{10} \cdot 10^{-22}$ Вт/(м <sup>2</sup> ·Гц)									
		65	75	100	125	150	175	200	225	250	275
560	VC	8,38-04	1,37-03	2,60-03	4,89-03	8,08-03	1,22-02	1,61-02	2,23-02	2,91-02	3,69-02
560	VB	5,69-05	9,27-05	1,77-04	3,32-04	5,48-04	8,28-04	1,09-03	1,51-03	1,97-03	2,51-03
570	VC	7,09-04	1,17-03	2,26-03	4,27-03	7,16-03	1,09-02	1,44-02	2,01-02	2,64-02	3,37-02
570	VB	4,82-05	7,96-05	1,53-04	2,91-04	4,87-04	7,41-03	9,81-03	1,37-03	1,80-03	2,29-03
580	VC	6,00-04	1,00-03	1,96-03	3,74-03	6,35-03	9,74-03	1,30-02	1,81-02	2,40-02	3,08-02
580	VB	4,09-05	6,84-05	1,33-04	2,55-04	4,33-04	6,64-04	8,84-04	1,24-03	1,64-03	2,10-03
590	VC	5,09-04	8,61-04	1,70-03	3,28-03	5,65-03	8,71-03	1,17-02	1,65-02	2,19-02	2,82-02
590	VB	3,48-05	5,89-05	1,16-04	2,24-04	3,86-04	5,95-04	7,98-04	1,13-03	1,53-03	1,92-03
600	VC	4,33-04	7,41-04	1,48-03	2,88-03	5,02-03	7,81-03	1,05-02	1,49-02	2,00-02	2,58-02
600	VB	2,96-05	5,07-05	1,01-04	1,97-04	3,44-04	5,35-04	7,21-04	1,02-03	1,37-03	1,77-03
610	VC	3,17-04	5,18-04	1,20-03	2,49-03	4,51-03	7,01-03	1,10-02	1,65-02	2,28-02	3,15-02
610	VB	2,18-05	3,56-05	8,24-05	1,71-04	3,09-04	4,81-04	7,53-04	1,13-03	1,56-03	2,16-03
620	VC	2,74-04	4,24-04	1,01-03	2,18-03	4,03-03	6,31-03	9,95-03	1,49-02	2,07-02	2,88-02
620	VB	1,88-05	2,92-05	6,98-05	1,50-04	2,77-04	4,34-04	6,84-04	1,03-03	1,43-03	1,98-03
630	VC	2,39-04	3,57-04	8,68-04	1,92-03	3,61-03	5,70-03	9,02-03	1,36-02	1,89-02	2,63-02
630	VB	1,65-05	2,46-05	5,99-05	1,33-04	2,49-04	3,93-04	6,22-04	9,36-04	1,30-03	1,81-03
640	VC	2,11-04	3,06-04	7,51-04	1,70-03	3,24-03	5,14-03	7,99-03	1,23-02	1,73-02	2,40-02
640	VB	1,46-05	2,12-05	5,19-05	1,18-04	2,24-04	3,55-04	5,66-04	8,52-04	1,19-03	1,66-03
650	VC	1,87-04	2,67-04	6,55-04	1,51-03	2,91-03	4,65-03	7,43-03	1,12-02	1,57-02	2,19-02
650	VB	1,30-05	1,85-05	4,54-05	1,05-04	2,01-04	3,22-04	5,14-04	7,76-04	1,09-03	1,52-03
660	VC	1,67-04	2,34-04	5,76-04	1,34-03	2,61-03	4,21-03	6,74-03	1,02-02	1,44-02	2,00-02
660	VB	1,16-05	1,63-05	4,00-05	9,33-05	1,81-04	2,92-04	4,68-04	7,07-04	9,96-04	1,39-03
670	VC	1,50-04	2,08-04	5,09-04	1,20-03	2,35-03	3,81-03	6,12-03	9,26-03	1,31-02	1,83-02
670	VB	1,05-05	1,45-05	3,54-05	8,34-05	1,63-04	2,65-04	4,26-04	6,44-04	9,10-04	1,27-03
680	VC	1,36-04	1,89-04	4,53-04	1,07-03	2,12-03	3,45-03	5,56-03	8,42-03	1,20-02	1,67-02
680	VB	9,46-06	1,29-05	3,15-05	7,48-05	1,48-04	2,40-04	3,87-04	5,87-04	8,33-04	1,16-03
690	VC	1,23-04	1,67-04	4,04-04	9,63-04	1,91-03	3,13-03	5,05-03	7,66-03	1,09-02	1,53-02
690	VB	8,60-06	1,16-05	2,82-05	6,72-05	1,34-04	2,18-04	3,53-04	5,35-04	7,62-04	1,07-03
700	VC	1,12-04	1,51-04	3,63-04	8,65-04	1,73-03	2,84-03	4,59-03	6,97-03	9,96-03	1,40-02
700	VB	7,84-06	1,05-05	2,54-05	6,05-05	1,21-04	1,99-04	3,21-04	4,87-04	6,97-04	9,76-04
710	VC	1,02-04	1,37-04	3,26-04	7,79-04	1,56-03	2,58-03	4,17-03	6,34-03	9,09-03	1,28-02
710	VB	7,17-06	9,58-06	2,29-05	5,47-05	1,10-04	1,81-04	2,92-04	4,45-04	6,37-04	8,94-04
720	VC	9,36-05	1,24-04	2,95-04	7,03-04	1,41-03	2,34-03	3,80-03	5,77-03	8,30-03	1,17-02
720	VB	6,58-06	8,73-06	2,07-05	4,94-05	9,94-05	1,65-04	2,67-04	4,05-04	5,83-04	8,19-04
730	VC	8,59-05	1,14-04	2,67-04	6,36-04	1,28-03	2,13-03	3,45-03	5,25-03	7,58-03	1,07-02
730	VB	6,05-06	8,00-06	1,88-05	4,48-05	9,03-05	1,50-04	2,43-04	3,70-04	5,34-04	7,50-04
740	VC	7,91-05	1,04-04	2,43-04	5,76-04	1,16-03	1,94-03	3,14-03	4,78-03	6,92-03	9,74-03
740	VB	5,58-06	7,34-06	1,71-05	4,06-05	8,21-05	1,37-04	2,22-04	3,37-04	4,88-04	6,87-04
750	VC	7,29-05	9,56-05	2,21-04	5,23-04	1,06-03	1,77-03	2,85-03	4,36-03	6,32-03	8,91-03
750	VB	5,16-06	6,76-06	1,56-05	3,70-05	7,47-05	1,25-04	2,02-04	3,08-04	4,47-04	6,30-04
760	VC	6,74-05	8,81-05	2,02-04	4,75-04	9,60-04	1,61-03	2,60-03	3,97-03	5,78-03	8,14-03
760	VB	4,78-06	6,24-06	1,43-05	3,37-05	6,80-05	1,14-04	1,84-04	2,81-04	4,03-04	5,77-04
770	VC	6,24-05	8,13-05	1,85-04	4,32-04	8,73-04	1,47-03	2,37-03	3,62-03	5,28-03	7,45-03
770	VB	4,43-06	5,78-06	1,31-05	3,07-05	6,20-05	1,04-04	1,68-04	2,57-04	3,75-04	5,29-04
780	VC	5,79-05	7,52-05	1,69-04	3,94-04	7,95-04	1,34-03	2,16-03	3,30-03	4,82-03	6,81-03
780	VB	4,12-06	5,35-06	1,21-05	2,80-05	5,66-05	9,53-05	1,53-04	2,34-04	3,43-04	4,85-04
790	VC	5,38-05	6,97-05	1,56-04	3,60-04	7,25-04	1,22-03	1,96-03	3,00-03	4,41-03	6,23-03
790	VB	3,83-06	4,97-06	1,11-05	2,56-05	5,17-05	8,72-05	1,40-04	2,14-04	3,14-04	4,44-04
800	VC	5,90-05	6,48-05	1,43-04	3,29-04	6,61-04	1,12-03	1,79-03	2,74-03	4,03-03	5,76-03
800	VB	3,58-06	4,63-06	1,02-05	2,35-05	4,72-05	7,98-05	1,28-04	1,96-04	2,88-04	4,07-04
810	VC	4,66-05	6,02-05	1,32-04	3,01-04	6,03-04	1,02-03	1,63-03	2,50-03	3,68-03	5,21-03
810	VB	3,34-06	4,32-06	9,46-06	2,15-05	4,32-05	7,31-05	1,17-04	1,79-04	2,64-04	3,73-04
820	VC	4,35-05	5,61-05	1,22-04	2,76-04	5,51-04	9,34-04	1,49-03	2,28-03	3,37-03	4,77-03
820	VB	3,13-06	4,03-06	8,75-06	1,98-05	3,95-05	6,70-04	1,07-04	1,63-04	2,42-04	3,42-04
830	VC	4,07-05	5,24-05	1,13-04	2,53-04	5,04-04	8,55-04	1,35-03	2,08-03	3,08-03	4,36-03
830	VB	2,92-06	3,77-06	8,12-06	1,82-05	3,62-05	6,15-05	9,74-05	1,49-04	2,21-04	3,14-04
840	VC	3,80-05	4,89-05	1,04-04	2,32-04	4,61-04	7,83-04	1,24-03	1,90-03	2,81-03	3,99-03
840	VB	2,74-06	3,53-06	7,53-06	1,67-05	3,32-05	5,64-05	8,90-05	1,37-04	2,03-04	2,88-04
850	VC	3,56-05	4,58-05	9,69-05	2,13-04	4,22-04	7,18-04	1,13-03	1,73-03	2,57-03	3,65-03
850	VB	2,58-06	3,31-06	7,00-06	1,54-05	3,05-05	5,18-05	8,14-05	1,25-04	1,86-04	2,64-04
860	VC	3,34-05	4,29-05	9,00-05	1,96-04	3,87-04	6,58-04	1,03-03	1,58-03	2,35-03	3,34-03
860	VB	2,42-06	3,11-06	6,51-06	1,42-05	2,80-05	4,76-05	7,44-05	1,14-04	1,70-04	2,42-04
870	VC	3,14-05	4,02-05	8,36-05	1,81-04	3,55-04	6,04-04	9,38-04	1,44-03	2,15-03	3,06-03
870	VB	2,28-06	2,92-06	6,06-06	1,31-05	2,57-05	4,38-05	6,80-05	1,05-04	1,56-04	2,22-04

Высота, км	Затраты	Фиксированный уровень солнечной активности $F_{10} \cdot 10^{-22}$ Вт/(м <sup>2</sup> ·Гц)									
		65	75	100	125	150	175	200	225	250	275
880	VC	2.95-05	3.78-05	7.78-05	1.67-04	3.25-04	5.54-04	8.56-04	1.32-03	1.97-03	2.80-03
880	VB	2.14-06	2.75-06	5.65-06	1.21-05	2.36-05	4.02-05	6.22-05	9.56-05	1.43-04	2.03-04
890	VC	2.77-05	3.55-05	7.25-05	1.54-04	2.99-04	5.09-04	7.82-04	1.20-03	1.80-03	2.56-03
890	VB	2.02-06	2.69-06	5.28-06	1.12-05	2.17-05	3.70-05	5.69-05	8.75-05	1.31-04	1.87-04
900	VC	2.61-01	3.34-05	6.76-05	1.42-04	2.74-04	4.67-04	7.14-04	1.10-03	1.65-03	2.35-03
900	VB	1.91-06	2.44-06	4.93-06	1.04-05	2.00-05	3.41-05	5.21-05	8.01-05	1.20-04	1.71-04
910	VC	2.46-05	3.15-05	6.31-05	1.31-04	2.52-04	4.30-04	6.52-04	1.00-03	1.51-03	2.15-03
910	VB	1.80-06	2.30-06	4.61-06	9.60-06	1.84-05	3.14-05	4.77-05	7.34-05	1.10-04	1.57-04
920	VC	2.32-05	2.97-05	5.90-05	1.22-04	2.32-04	3.95-04	5.96-04	9.17-04	1.38-03	1.97-03
920	VB	1.70-06	2.17-06	4.33-06	8.90-06	1.70-05	2.89-05	4.37-05	6.72-05	1.01-04	1.44-04
930	VC	2.19-05	2.80-05	5.52-05	1.13-04	2.14-04	3.63-04	5.45-04	8.38-04	1.27-03	1.80-03
930	VB	1.61-06	2.05-06	4.05-06	8.26-06	1.57-05	2.67-05	4.00-05	6.15-05	9.30-05	1.32-04
940	VC	2.06-05	2.64-05	5.17-05	1.04-04	1.97-04	3.35-04	4.98-04	7.66-04	1.16-03	1.65-03
940	VB	1.52-06	1.95-06	3.80-06	7.68-06	1.45-05	2.46-05	3.66-05	5.64-05	8.53-05	1.21-04
950	VC	1.95-06	2.50-05	4.84-05	9.67-05	1.81-04	3.08-04	4.55-04	7.01-04	1.06-03	1.51-03
950	VB	1.44-06	1.84-06	3.57-06	7.13-06	1.34-05	2.27-05	3.35-05	5.16-05	7.83-05	1.11-04
960	VC	1.85-05	2.36-05	4.54-05	8.98-05	1.67-04	2.84-04	4.16-04	6.41-04	9.73-04	1.38-03
960	VB	1.36-06	1.75-06	3.35-06	6.63-06	1.23-05	2.10-05	3.07-05	4.73-05	7.18-05	1.02-04
970	VC	1.75-05	2.23-05	4.26-05	8.34-05	1.54-04	2.62-04	3.81-04	5.86-04	8.91-04	1.27-03
970	VB	1.30-06	1.65-06	3.15-06	6.17-06	1.14-05	1.94-05	2.82-05	4.34-05	6.59-05	9.39-05
980	VC	1.65-05	2.12-05	4.00-05	7.75-05	1.42-04	2.41-04	3.48-04	5.36-04	8.16-04	1.16-03
980	VB	1.23-06	1.57-06	2.96-06	5.75-06	1.06-05	1.79-05	2.58-05	3.98-05	6.05-05	8.62-05
990	VC	1.57-05	2.00-05	3.76-05	7.36-05	1.31-04	2.23-04	3.19-04	4.91-04	7.48-04	1.06-03
990	VB	1.17-06	1.49-06	2.79-06	5.54-06	9.77-06	1.65-05	2.37-05	3.65-05	5.56-05	7.91-05
1000	VC	1.49-05	1.90-05	3.54-05	7.05-05	1.21-04	2.05-04	2.92-04	4.49-04	6.85-04	9.76-04
1000	VB	1.11-06	1.41-06	2.63-06	5.26-06	9.05-06	1.53-05	2.17-05	3.34-05	5.10-05	7.27-05
1010	VC	1.41-05	1.80-05	3.33-05	6.66-05	1.12-04	1.90-04	2.67-04	4.11-04	6.28-04	8.94-04
1010	VB	1.06-06	1.35-06	2.48-06	4.96-06	8.38-06	1.42-05	1.99-05	3.07-05	4.69-05	6.67-05
1020	VC	1.34-05	1.71-05	3.13-05	6.26-05	1.04-04	1.75-04	2.44-04	3.76-04	5.76-04	8.20-04
1020	VB	1.00-06	1.28-06	2.34-06	4.68-06	7.77-06	1.31-05	1.83-05	2.91-05	4.30-05	6.13-05
1030	VC	1.27-05	1.63-05	2.95-05	5.90-05	9.61-05	1.62-04	2.24-04	3.45-04	5.28-04	7.51-04
1030	VB	9.55-07	1.22-06	2.22-06	4.44-06	7.20-06	1.21-05	1.68-05	2.58-05	3.95-05	5.63-05
1040	VC	1.21-05	1.55-05	2.78-05	5.56-05	8.90-05	1.50-04	2.05-04	3.16-04	4.84-04	6.89-04
1040	VB	9.10-07	1.16-06	2.09-06	4.18-06	6.68-06	1.12-05	1.54-05	2.37-05	3.63-05	5.17-05
1050	VC	1.15-05	1.47-05	2.63-05	5.26-05	8.24-05	1.38-04	1.88-04	2.89-04	4.43-04	6.31-04
1050	VB	8.70-07	1.11-06	1.98-06	3.96-06	6.20-06	1.04-05	1.41-05	2.17-05	3.34-05	4.75-05
1060	VC	1.09-05	1.40-05	2.48-05	4.96-05	7.64-05	1.28-04	1.72-04	2.65-04	4.07-04	5.79-04
1060	VB	8.24-07	1.06-06	1.87-06	3.74-06	5.76-06	9.66-06	1.30-05	2.00-05	3.07-05	4.36-05
1070	VC	1.04-05	1.33-05	2.34-05	4.68-05	7.08-05	1.19-04	1.58-04	2.43-04	3.73-04	5.31-04
1070	VB	7.88-07	1.01-06	1.77-06	3.54-06	5.35-06	8.96-06	1.19-05	1.83-05	2.82-05	4.01-05
1080	VC	9.90-06	1.27-05	2.21-05	4.42-05	6.57-05	1.10-04	1.45-04	2.23-04	3.42-04	4.87-04
1080	VB	7.49-07	9.65-07	1.68-06	3.36-06	5.14-06	8.31-06	1.10-05	1.68-05	2.59-05	3.68-05
1090	VC	9.43-06	1.21-05	2.09-05	4.18-05	6.10-05	1.02-04	1.33-04	2.04-04	3.14-04	4.46-04
1090	VB	7.17-07	9.20-07	1.59-06	3.18-06	4.62-06	7.71-06	1.01-05	1.55-05	2.38-05	3.38-05
1100	VC	8.99-06	1.15-05	1.98-05	3.96-05	5.66-05	9.42-05	1.22-04	1.87-04	2.88-04	4.09-04
1100	VB	6.88-07	8.79-07	1.51-06	3.02-06	4.31-06	7.16-06	9.25-06	1.42-05	2.19-05	3.11-05
1110	VC	8.57-06	1.10-05	1.87-05	3.74-05	5.25-05	8.73-05	1.12-04	1.71-04	2.64-04	3.75-04
1110	VB	6.53-07	8.35-07	1.43-06	2.86-06	4.00-06	6.65-06	8.50-06	1.31-05	2.01-05	2.86-05
1120	VC	8.18-06	1.05-05	1.77-05	3.54-05	5.14-05	8.10-05	1.02-04	1.57-04	2.42-04	3.44-04
1120	VB	6.21-07	8.03-07	1.35-06	2.70-06	3.72-06	6.18-06	7.81-06	1.20-05	1.85-05	2.63-05
1130	VC	7.80-06	1.00-05	1.68-05	3.36-05	4.84-05	7.51-05	9.40-05	1.44-04	2.22-04	3.16-04
1130	VB	6.01-07	7.73-07	1.28-06	2.56-06	3.47-06	5.74-06	7.18-06	1.10-05	1.70-05	2.42-05
1140	VC	7.44-06	9.57-06	1.59-05	3.18-05	4.22-05	6.97-05	8.62-05	1.32-04	2.04-04	2.90-04
1140	VB	5.73-07	7.33-07	1.22-06	2.44-06	3.23-06	5.34-06	6.60-06	1.01-05	1.56-05	2.22-05
1150	VC	7.11-06	9.14-06	1.51-05	3.02-05	4.14-05	6.47-05	7.92-05	1.21-04	1.87-04	2.66-04
1150	VB	5.46-07	7.06-07	1.16-06	2.32-06	3.02-06	4.97-06	6.08-06	9.32-06	1.44-05	2.04-05
1160	VC	6.80-06	8.73-06	1.43-05	2.86-05	3.96-05	6.01-05	7.27-05	1.11-04	1.72-04	2.44-04
1160	VB	5.24-07	6.77-07	1.10-06	2.20-06	2.82-06	4.62-06	5.59-06	8.57-06	1.32-05	1.88-05
1170	VC	6.49-06	8.35-06	1.36-05	2.72-05	3.40-05	5.58-05	6.87-05	1.02-04	1.58-04	2.24-04
1170	VB	5.06-07	6.42-07	1.05-06	2.10-06	2.82-06	4.31-06	5.14-06	7.88-06	1.22-05	1.73-05
1180	VC	6.21-06	7.99-06	1.29-05	2.58-05	3.17-05	5.19-05	6.13-05	9.39-05	1.45-04	2.06-04
1180	VB	4.82-07	6.21-07	9.95-07	1.56-06	2.45-06	4.00-06	4.73-06	7.25-06	1.12-05	1.59-05
1190	VC	5.94-06	7.64-06	1.23-05	2.46-05	2.95-05	4.82-05	5.63-05	8.62-05	1.33-04	1.89-04
1190	VB	4.60-07	5.91-07	9.55-07	1.48-06	2.29-06	3.73-06	4.36-06	6.67-06	1.46-05	1.46-05



Продолжение табл. 7

Высота, км	Затраты	Фиксированный уровень солнечной активности $F_{10} \cdot 10^{-22}$ Вт/(м <sup>2</sup> ·Гц)									
		65	75	100	125	150	175	200	225	250	275
1200	VC	5.68-06	7.32-06	1.17-05	1.79-05	2.75-05	4.48-05	5.18-05	7.92-05	1.22-04	1.73-04
1200	VB	4.39-07	5.67-07	9.04-07	1.39-06	2.14-06	3.48-06	4.01-06	6.14-06	9.48-06	1.34-05
1210	VC	5.44-06	7.01-06	1.11-05	1.68-05	2.57-05	4.17-05	4.76-05	7.27-05	1.12-04	1.59-04
1210	VB	4.24-07	5.46-07	8.64-07	1.31-06	2.00-06	3.24-06	3.69-06	5.65-06	8.73-06	1.24-05
1220	VC	5.20-06	6.71-06	1.05-05	1.58-05	2.40-05	3.88-05	4.37-05	6.68-05	1.03-04	1.46-04
1220	VB	4.09-07	5.24-07	8.24-07	1.23-06	1.83-06	3.02-06	3.40-06	5.20-06	8.04-06	1.14-05
1230	VC	4.98-06	6.43-06	1.00-05	1.49-05	2.23-05	3.61-05	4.02-05	6.14-05	9.49-05	1.34-04
1230	VB	3.93-07	5.06-07	7.83-07	1.17-06	1.75-06	2.82-06	3.14-06	4.79-06	7.40-06	1.05-05
1240	VC	4.78-06	6.17-06	9.55-06	1.40-05	2.09-05	3.36-05	3.70-05	5.64-05	8.72-05	1.23-04
1240	VB	3.75-07	4.82-07	7.49-07	1.10-06	1.63-06	2.62-06	2.89-06	4.41-06	6.81-06	9.62-06
1250	VC	4.57-06	5.91-06	9.09-06	1.32-05	1.95-05	3.13-05	3.40-05	5.19-05	8.01-05	1.13-04
1250	VB	3.59-07	4.60-07	7.12-07	1.04-06	1.53-06	2.45-06	2.67-06	4.06-06	6.27-06	8.85-06
1260	VC	4.38-06	5.67-06	8.66-06	1.25-05	1.82-05	2.91-05	3.13-05	4.77-05	7.36-05	1.04-04
1260	VB	3.42-07	4.50-07	6.82-07	9.79-07	1.43-06	2.29-06	2.45-06	3.74-06	5.78-06	8.15-06
1270	VC	4.21-06	5.44-06	8.24-06	1.18-05	1.70-05	2.71-05	2.88-05	4.38-05	6.77-05	9.53-05
1270	VB	3.33-07	4.29-07	6.53-07	9.26-07	1.34-06	2.14-06	2.26-06	3.45-06	5.32-06	7.49-06
1280	VC	4.04-06	5.22-06	7.85-06	1.11-05	1.59-05	2.53-05	2.65-05	4.03-05	6.22-05	8.76-05
1280	VB	3.24-07	4.15-07	6.21-07	8.79-07	1.25-06	1.99-06	2.09-06	3.17-06	4.90-06	6.90-06
1290	VC	3.87-06	5.01-06	7.49-06	1.05-05	1.49-05	2.36-05	2.44-05	3.71-05	5.72-05	8.04-05
1290	VB	3.08-07	3.99-07	5.91-07	8.24-07	1.17-06	1.86-06	1.93-06	2.92-06	4.52-06	6.35-06
1300	VC	3.71-06	4.81-06	7.14-06	9.87-06	1.39-05	2.20-05	2.24-05	3.41-05	5.26-05	7.39-05
1300	VB	2.94-07	3.85-07	5.67-07	7.83-07	1.10-06	1.74-06	1.78-06	2.70-06	4.16-06	5.85-06
1310	VC	3.57-06	4.62-06	6.82-06	9.31-06	1.30-05	2.05-05	2.06-05	3.13-05	4.84-05	6.79-05
1310	VB	2.84-07	3.64-07	5.40-07	7.39-07	1.03-06	1.63-06	1.64-06	2.48-06	3.83-06	5.38-06
1320	VC	3.42-06	4.44-06	6.50-06	8.80-06	1.22-05	1.91-05	1.90-05	2.88-05	4.45-05	6.24-05
1320	VB	2.73-07	3.53-07	5.15-07	6.97-07	9.65-07	1.52-06	1.51-06	2.29-06	3.53-06	4.96-06
1330	VC	3.29-06	4.27-06	6.21-06	8.31-06	1.14-05	1.79-05	1.75-05	2.65-05	4.09-05	5.73-05
1330	VB	2.62-07	3.42-07	4.95-07	6.64-07	9.10-07	1.42-06	1.39-06	2.11-06	3.25-06	4.56-06
1340	VC	3.16-06	4.10-06	5.93-06	7.86-06	1.07-05	1.67-05	1.61-05	2.44-05	3.76-05	5.27-05
1340	VB	2.52-07	3.33-07	4.71-07	6.26-07	8.51-07	1.33-06	1.28-06	1.95-06	3.00-06	4.20-06
1350	VC	3.03-06	3.95-06	5.66-06	7.42-06	9.99-06	1.56-05	1.49-05	2.25-05	3.46-05	4.84-05
1350	VB	2.46-07	3.18-07	4.50-07	5.95-07	7.97-07	1.24-06	1.19-06	1.80-06	2.76-06	3.87-06
1360	VC	2.91-06	3.79-06	5.41-06	7.02-06	9.35-06	1.46-05	1.37-05	2.07-05	3.18-05	4.45-05
1360	VB	2.37-07	3.08-07	4.33-07	5.62-07	7.49-07	1.17-06	1.10-06	1.66-06	2.55-06	3.57-06
1370	VC	2.80-06	3.65-06	5.17-06	6.64-06	8.77-06	1.36-05	1.26-05	1.91-05	2.93-05	4.09-05
1370	VB	2.27-07	2.94-07	4.19-07	5.35-07	7.06-07	1.09-06	1.01-06	1.53-06	2.35-06	3.28-06
1380	VC	2.70-06	3.51-06	4.94-06	6.28-06	8.22-06	1.27-05	1.16-05	1.76-05	2.70-05	3.76-05
1380	VB	2.17-07	2.84-07	3.99-07	5.06-07	6.64-07	1.02-06	9.31-07	1.41-06	2.17-06	3.02-06
1390	VC	2.59-06	3.38-06	4.72-06	5.95-06	7.71-06	1.19-05	1.07-05	1.62-05	2.48-05	3.46-05
1390	VB	2.11-07	2.73-07	3.80-07	4.82-07	6.21-07	9.55-07	8.70-07	1.30-06	2.00-06	2.78-06
1400	VC	2.50-06	3.25-06	4.52-06	5.63-06	7.23-06	1.11-05	9.89-06	1.49-05	2.28-05	3.18-05
1400	VB	2.03-07	2.62-07	3.64-07	4.55-07	5.85-07	8.99-07	7.97-07	1.20-06	1.84-06	2.56-06
1410	VC	2.40-06	3.13-06	4.32-06	5.33-06	6.79-06	1.04-05	9.12-06	1.37-05	2.10-05	2.92-05
1410	VB	1.93-07	2.57-07	3.53-07	4.29-07	5.46-07	8.40-07	7.39-07	1.11-06	1.70-06	2.37-06
1420	VC	2.31-06	3.02-06	4.13-06	5.05-06	6.37-06	9.71-06	8.41-06	1.26-05	1.94-05	2.69-05
1420	VB	1.87-07	2.46-07	3.33-07	4.09-07	5.15-07	7.88-07	6.88-07	1.03-06	1.57-06	2.17-06
1430	VC	2.23-06	2.91-06	3.96-06	4.79-06	5.98-06	9.09-06	7.76-06	1.17-05	1.78-05	2.47-05
1430	VB	1.82-07	2.37-07	3.24-07	3.85-07	4.90-07	7.39-07	6.31-07	9.43-07	1.44-06	2.00-06
1440	VC	2.14-06	2.80-06	3.79-06	4.53-06	5.61-06	8.51-06	7.16-06	1.07-05	1.64-05	2.27-05
1440	VB	1.71-07	2.27-07	3.13-07	3.69-07	4.60-07	6.97-07	5.89-07	8.74-07	1.34-06	1.85-06
1450	VC	2.06-06	2.70-06	3.63-06	4.30-06	5.27-06	7.96-06	6.60-06	9.90-06	1.51-05	2.09-05
1450	VB	1.71-07	2.22-07	3.02-07	3.53-07	4.29-07	6.53-07	5.35-07	8.03-07	1.23-06	1.70-06
1460	VC	1.99-06	2.60-06	3.47-06	4.08-06	4.96-06	7.46-06	6.10-06	9.13-06	1.39-05	1.92-05
1460	VB	1.61-07	2.17-07	2.84-07	3.33-07	4.09-07	6.10-07	5.00-07	7.49-07	1.14-06	1.57-06
1470	VC	1.92-06	2.51-06	3.33-06	3.87-06	4.66-06	6.98-06	5.63-06	8.41-06	1.28-05	1.77-05
1470	VB	1.61-07	2.03-07	2.73-07	3.18-07	3.85-07	5.73-07	4.60-07	6.88-07	1.05-06	1.44-06
1480	VC	1.84-06	2.42-06	3.19-06	3.67-06	4.38-06	6.54-06	5.20-06	7.76-06	1.18-05	1.63-05
1480	VB	1.51-07	1.98-07	2.62-07	3.02-07	3.59-07	5.35-07	4.29-07	6.37-07	9.70-07	1.34-06
1490	VC	1.78-06	2.33-06	3.06-06	3.48-06	4.11-06	6.13-06	4.79-06	7.16-05	1.09-05	1.50-05
1490	VB	1.51-07	1.93-07	2.52-07	2.89-07	3.42-07	5.06-07	3.99-07	5.91-07	8.94-07	1.23-06
1500	VC	1.71-06	2.25-06	2.93-06	3.30-06	3.87-06	5.75-06	4.43-06	6.60-06	1.00-05	1.38-05
1500	VB	1.42-07	1.87-07	2.42-07	2.73-07	3.24-07	4.71-07	3.64-07	5.46-07	8.24-07	1.14-06

Минимальные затраты характеристической скорости за сутки (VC) и за виток (VB), м/с

Высота, км	Затраты	Фиксированный уровень солнечной активности $F_{10.7}$ , $10^{-22}$ Вт/(м <sup>2</sup> ·Гц)													
		65	75	100	125	150	175	200	225	250	275				
120	VC	1.97+02	1.97+02	1.97+02	1.97+02	1.97+02	1.97+02	1.97+02	1.97+02	1.97+02	1.97+02	1.97+02	1.97+02	1.97+02	1.97+02
120	VB	1.17+01	1.17+01	1.17+01	1.17+01	1.17+01	1.17+01	1.17+01	1.17+01	1.17+01	1.17+01	1.17+01	1.17+01	1.17+01	1.17+01
125	VC	9.78+01	9.82+01	1.02+02	1.01+02	1.01+02	1.02+02	1.04+02	1.04+02	1.04+02	1.04+02	1.04+02	1.06+02	1.06+02	1.06+02
125	VB	5.93+00	5.96+00	6.16+00	6.11+00	6.14+00	6.16+00	6.31+00	6.32+00	6.32+00	6.40+00	6.40+00	6.41+00	6.41+00	6.41+00
130	VC	5.75+01	5.81+01	6.10+01	6.15+01	6.26+01	6.32+01	6.52+01	6.58+01	6.58+01	6.70+01	6.70+01	6.74+01	6.74+01	6.74+01
130	VB	3.51+00	3.55+00	3.72+00	3.76+00	3.82+00	3.85+00	3.98+00	4.02+00	4.02+00	4.09+00	4.09+00	4.11+00	4.11+00	4.11+00
135	VC	3.68+01	3.74+01	3.96+01	4.07+01	4.20+01	4.27+01	4.43+01	4.49+01	4.49+01	4.60+01	4.60+01	4.65+01	4.65+01	4.65+01
135	VB	2.26+00	2.30+00	2.43+00	2.50+00	2.57+00	2.62+00	2.72+00	2.76+00	2.76+00	2.82+00	2.82+00	2.85+00	2.85+00	2.85+00
140	VC	2.49+01	2.54+01	2.71+01	2.84+01	2.97+01	3.04+01	3.16+01	3.22+01	3.22+01	3.32+01	3.32+01	3.36+01	3.36+01	3.36+01
140	VB	1.53+00	1.57+00	1.67+00	1.75+00	1.82+00	1.87+00	1.94+00	1.98+00	1.98+00	2.04+00	2.04+00	2.07+00	2.07+00	2.07+00
145	VC	1.75+01	1.79+01	1.92+01	2.06+01	2.17+01	2.24+01	2.33+01	2.39+01	2.39+01	2.47+01	2.47+01	2.51+01	2.51+01	2.51+01
145	VB	1.08+00	1.11+00	1.19+00	1.27+00	1.34+00	1.38+00	1.44+00	1.47+00	1.47+00	1.52+00	1.52+00	1.55+00	1.55+00	1.55+00
150	VC	1.26+01	1.30+01	1.40+01	1.53+01	1.63+01	1.69+01	1.77+01	1.82+01	1.82+01	1.89+01	1.89+01	1.93+01	1.93+01	1.93+01
150	VB	7.79+01	8.05+01	8.65+01	9.44+01	1.01+02	1.04+02	1.09+02	1.12+02	1.12+02	1.16+02	1.16+02	1.19+02	1.19+02	1.19+02
155	VC	9.31+00	9.67+00	1.04+01	1.16+01	1.25+01	1.30+01	1.36+01	1.41+01	1.41+01	1.47+01	1.47+01	1.50+01	1.50+01	1.50+01
155	VB	5.77+01	5.99+01	6.46+01	7.18+01	7.74+01	8.07+01	8.44+01	8.74+01	8.74+01	9.08+01	9.08+01	9.30+01	9.30+01	9.30+01
160	VC	7.00+00	7.31+00	7.90+00	8.95+00	9.75+00	1.02+01	1.07+01	1.11+01	1.11+01	1.16+01	1.16+01	1.19+01	1.19+01	1.19+01
160	VB	4.34+01	4.54+01	4.90+01	5.55+01	6.05+01	6.34+01	6.63+01	6.91+01	6.91+01	7.20+01	7.20+01	7.39+01	7.39+01	7.39+01
165	VC	5.35+00	5.62+00	6.08+00	7.01+00	7.71+00	8.12+00	8.51+00	8.90+00	8.90+00	9.30+00	9.30+00	9.59+00	9.59+00	9.59+00
165	VB	3.32+01	3.49+01	3.78+01	4.35+01	4.79+01	5.04+01	5.29+01	5.53+01	5.53+01	5.77+01	5.77+01	5.93+01	5.93+01	5.93+01
170	VC	4.14+00	4.37+00	4.74+00	5.55+00	6.17+00	6.53+00	6.85+00	7.20+00	7.20+00	7.54+00	7.54+00	7.79+00	7.79+00	7.79+00
170	VB	2.58+01	2.72+01	2.95+01	3.45+01	3.84+01	4.06+01	4.26+01	4.47+01	4.47+01	4.69+01	4.69+01	4.84+01	4.84+01	4.84+01
175	VC	3.24+00	3.44+00	3.73+00	4.45+00	4.99+00	5.31+00	5.57+00	5.87+00	5.87+00	6.16+00	6.16+00	6.39+00	6.39+00	6.39+00
175	VB	2.02+01	2.14+01	2.32+01	2.77+01	3.11+01	3.30+01	3.47+01	3.66+01	3.66+01	3.84+01	3.84+01	3.98+01	3.98+01	3.98+01
180	VC	2.54+00	2.74+00	2.99+00	3.61+00	4.09+00	4.37+00	4.59+00	4.86+00	4.86+00	5.10+00	5.10+00	5.30+00	5.30+00	5.30+00
180	VB	1.58+01	1.71+01	1.86+01	2.25+01	2.55+01	2.72+01	2.86+01	3.03+01	3.03+01	3.18+01	3.18+01	3.31+01	3.31+01	3.31+01
185	VC	2.05+00	2.22+00	2.46+00	3.01+00	3.43+00	3.69+00	3.88+00	4.12+00	4.12+00	4.33+00	4.33+00	4.52+00	4.52+00	4.52+00
185	VB	1.28+01	1.39+01	1.53+01	1.88+01	2.14+01	2.30+01	2.42+01	2.57+01	2.57+01	2.71+01	2.71+01	2.82+01	2.82+01	2.82+01
190	VC	1.67+00	1.80+00	2.03+00	2.52+00	2.88+00	3.12+00	3.29+00	3.52+00	3.52+00	3.70+00	3.70+00	3.87+00	3.87+00	3.87+00
190	VB	1.04+01	1.13+01	1.27+01	1.58+01	1.80+01	1.95+01	2.06+01	2.20+01	2.20+01	2.31+01	2.31+01	2.42+01	2.42+01	2.42+01
195	VC	1.36+00	1.47+00	1.69+00	2.12+00	2.44+00	2.65+00	2.81+00	3.01+00	3.01+00	3.18+00	3.18+00	3.34+00	3.34+00	3.34+00
195	VB	8.52+02	9.22+02	1.05+03	1.33+03	1.52+03	1.66+03	1.76+03	1.88+03	1.88+03	1.99+03	1.99+03	2.09+03	2.09+03	2.09+03
200	VC	1.12+00	1.21+00	1.40+00	1.78+00	2.07+00	2.26+00	2.40+00	2.59+00	2.59+00	2.74+00	2.74+00	2.89+00	2.89+00	2.89+00
200	VB	6.99+02	7.57+02	8.80+02	1.12+03	1.29+03	1.42+03	1.51+03	1.62+03	1.62+03	1.72+03	1.72+03	1.81+03	1.81+03	1.81+03
205	VC	9.17+01	9.95+01	1.17+02	1.51+02	1.76+02	1.94+02	2.07+02	2.24+02	2.24+02	2.38+02	2.38+02	2.51+02	2.51+02	2.51+02
205	VB	5.75+02	6.24+02	7.36+02	9.46+02	1.10+03	1.22+03	1.30+03	1.40+03	1.40+03	1.49+03	1.49+03	1.57+03	1.57+03	1.57+03
210	VC	7.56+01	8.23+01	9.84+01	1.28+02	1.50+02	1.66+02	1.78+02	1.94+02	1.94+02	2.06+02	2.06+02	2.19+02	2.19+02	2.19+02
210	VB	4.75+02	5.17+02	6.18+02	8.03+02	9.42+02	1.04+03	1.12+03	1.22+03	1.22+03	1.30+03	1.30+03	1.37+03	1.37+03	1.37+03
215	VC	6.26+01	6.83+01	8.28+01	1.09+02	1.28+02	1.43+02	1.54+02	1.68+02	1.68+02	1.80+02	1.80+02	1.91+02	1.91+02	1.91+02
215	VB	3.94+02	4.30+02	5.21+02	6.84+02	8.07+02	9.00+02	9.69+02	1.06+03	1.06+03	1.13+03	1.13+03	1.20+03	1.20+03	1.20+03
220	VC	5.20+01	5.69+01	6.99+01	9.28+01	1.10+02	1.24+02	1.34+02	1.47+02	1.47+02	1.58+02	1.58+02	1.68+02	1.68+02	1.68+02
220	VB	3.27+02	3.58+02	4.40+02	5.84+02	6.93+02	7.78+02	8.42+02	9.23+02	9.23+02	9.92+02	9.92+02	1.06+03	1.06+03	1.06+03
225	VC	4.33+01	4.76+01	5.92+01	7.93+01	9.48+01	1.07+02	1.16+02	1.28+02	1.28+02	1.38+02	1.38+02	1.48+02	1.48+02	1.48+02
225	VB	2.73+02	3.00+02	3.73+02	5.00+02	5.97+02	6.74+02	7.34+02	8.08+02	8.08+02	8.72+02	8.72+02	9.33+02	9.33+02	9.33+02
230	VC	3.62+01	3.99+01	5.03+01	6.80+01	8.18+01	9.28+01	1.02+02	1.12+02	1.12+02	1.22+02	1.22+02	1.31+02	1.31+02	1.31+02
230	VB	2.28+02	2.52+02	3.17+02	4.29+02	5.16+02	5.86+02	6.41+02	7.09+02	7.09+02	7.68+02	7.68+02	8.24+02	8.24+02	8.24+02
235	VC	3.03+01	3.36+01	4.28+01	5.84+01	7.07+01	8.07+01	8.89+01	9.87+01	9.87+01	1.08+02	1.08+02	1.16+02	1.16+02	1.16+02
235	VB	1.91+02	2.12+02	2.70+02	3.69+02	4.47+02	5.10+02	5.61+02	6.23+02	6.23+02	6.79+02	6.79+02	7.31+02	7.31+02	7.31+02
240	VC	2.51+01	2.83+01	3.65+01	5.03+01	6.13+01	7.03+01	7.80+01	8.69+01	8.69+01	9.51+01	9.51+01	1.03+02	1.03+02	1.03+02
240	VB	1.61+02	1.79+02	2.31+02	3.18+02	3.88+02	4.45+02	4.93+02	5.49+02	5.49+02	6.01+02	6.01+02	6.49+02	6.49+02	6.49+02
245	VC	2.14+01	2.39+01	3.12+01	4.34+01	5.33+01	6.14+01	6.85+01	7.67+01	7.67+01	8.44+01	8.44+01	9.14+01	9.14+01	9.14+01
245	VB	1.36+02	1.52+02	1.98+02	2.75+02	3.37+02	3.89+02	4.34+02	4.86+02	4.86+02	5.34+02	5.34+02	5.78+02	5.78+02	5.78+02
250	VC	1.81+01	2.03+01	2.68+01	3.75+01	4.64+01	5.38+01	6.04+01	6.78+01	6.78+01	7.50+01	7.50+01	8.14+01	8.14+01	8.14+01
250	VB	1.15+02	1.29+02	1.70+02	2.38+02	2.94+02	3.41+02	3.83+02	4.30+02	4.30+02	4.75+02	4.75+02	5.16+02	5.16+02	5.16+02
255	VC	1.53+01	1.73+01	2.30+01	3.25+01	4.04+01	4.72+01	5.33+01	6.01+01	6.01+01	6.68+01	6.68+01	7.28+01	7.28+01	7.28+01
255	VB	9.70+03	1.09+02	1.46+02	2.06+02	2.57+02	2.99+02	3.38+02	3.82+02	3.82+02	4.24+02	4.24+02	4.62+02	4.62+02	4.62+02
260	VC	1.30+01	1.47+01	1.98+01	2.82+01	3.53+01	4.14+01	4.71+01	5.34+01	5.34+01	5.96+01	5.96+01	6.51+01	6.51+01	6.51+01
260	VB	8.23+03	9.34+03	1.26+04	1.79+04	2.24+04	2.63+04	2.99+04	3.39+04	3.39+04	3.79+04	3.79+04	4.14+04	4.14+04	4.14+04
265	VC	1.10+01	1.26+01	1.71+01	2.45+01	3.09+01	3.65+01	4.18+01	4.75+01	4.75+01	5.33+01	5.33+01	5.84+01	5.84+01	5.84+01
265	VB	7.00+03	7.98+03	1.09+04	1.56+04	1.97+04	2.32+04	2.66+04	3.02+04	3.02+04	3.39+04	3.39+04	3.71+04	3.71+04	3.71+04
270	VC	9.37+02	1.07+01	1.47+01	2.14+01	2.71+01	3.21+01	3.71+01	4.23+01	4.23+01	4.77+01	4.77+01	5.25+01	5.25+01	5.25+01
270	VB	5.97+03	6.84+03	9.39+03	1.36+04	1.73+04	2.05+04	2.35+04	2.70+04	2.70+04	3.04+04	3.04+04	3.34+04	3.34+04	3.34+04
275	VC	7.99+02	9.21+02	1.28+03	1.87+03	2.38+03	2.84+03	3.30+03	3.78+03	3.78+03	4.28+03	4.28+03	4.72+03	4.72+03	4.72+03
275	VB	5.09+03	5.87+03	8.14+03	1.19+04	1.52+04	1.81+04	2.10+04	2.41+04	2.41+04	2.73+04	2.73+04	3.01+04	3.01+04	3.01+04
280	VC	6.83+02	7.91+02	1.11+03											

Высота, км	Загрязн.	Фиксированный уровень солнечной активности $F_{10}^{-22}$ Вт/(к <sup>2</sup> ·Гн)													
		65	75	100	125	150	175	200	225	250	275				
280	VB	4.36-03	5.05-03	7.07-03	1.04-02	1.34-02	1.60-02	1.87-02	2.16-02	2.46-02	2.72-02	2.85-02	3.03-01	3.46-01	3.84-01
285	VC	5.85-02	6.81-02	9.62-02	1.43-01	1.85-01	2.22-01	2.62-01	3.03-01	3.46-01	3.84-01	4.12-01	4.54-01	4.97-01	5.40-01
285	VB	3.74-03	4.35-03	6.15-03	9.12-03	1.18-02	1.42-02	1.67-02	1.93-02	2.21-02	2.46-02	2.72-02	2.99-01	3.27-01	3.55-01
290	VC	5.02-02	5.88-02	8.37-02	1.25-01	1.63-01	1.97-01	2.34-01	2.71-01	3.12-01	3.47-01	3.84-01	4.21-01	4.58-01	4.95-01
290	VB	3.21-03	3.76-03	5.36-03	8.03-03	1.04-02	1.26-02	1.50-02	1.74-02	2.00-02	2.22-02	2.46-02	2.72-02	2.99-01	3.27-01
295	VC	4.31-02	5.08-02	7.30-02	1.10-01	1.44-01	1.75-01	2.09-01	2.44-01	2.82-01	3.15-01	3.52-01	3.89-01	4.26-01	4.63-01
295	VB	2.76-03	3.25-03	4.67-03	7.03-03	9.23-03	1.12-02	1.34-02	1.56-02	1.81-02	2.01-02	2.26-02	2.51-02	2.76-02	3.01-02
300	VC	3.71-02	4.39-02	6.37-02	9.66-02	1.28-01	1.56-01	1.87-01	2.19-01	2.55-01	2.85-01	3.15-01	3.45-01	3.75-01	4.05-01
300	VB	2.38-03	2.82-03	4.09-03	6.19-03	8.18-03	9.99-03	1.20-02	1.41-02	1.63-02	1.83-02	2.03-02	2.23-02	2.43-02	2.63-02
310	VC	2.76-02	3.31-02	4.88-02	7.50-02	1.00-01	1.24-01	1.51-01	1.78-01	2.09-01	2.35-01	2.61-01	2.87-01	3.13-01	3.39-01
310	VB	1.77-03	2.13-03	3.13-03	4.82-03	6.45-03	7.95-03	9.71-03	1.14-02	1.34-02	1.51-02	1.71-02	1.91-02	2.11-02	2.31-02
320	VC	2.07-02	2.51-02	3.76-02	5.85-02	7.94-02	9.88-02	1.22-01	1.45-01	1.72-01	1.95-01	2.18-01	2.41-01	2.64-01	2.87-01
320	VB	1.33-03	1.61-03	2.42-03	3.77-03	5.11-03	6.36-03	7.88-03	9.35-03	1.11-02	1.26-02	1.41-02	1.56-02	1.71-02	1.86-02
330	VC	1.56-02	1.91-02	2.91-02	4.59-02	6.30-02	7.92-02	9.95-02	1.19-01	1.43-01	1.62-01	1.81-01	2.00-01	2.19-01	2.38-01
330	VB	1.00-03	1.23-03	1.88-03	2.96-03	4.07-03	5.11-03	6.42-03	7.68-03	9.22-03	1.05-02	1.20-02	1.35-02	1.50-02	1.65-02
340	VC	1.18-02	1.46-02	2.26-02	3.61-02	5.03-02	6.38-02	8.13-02	9.80-02	1.19-01	1.36-01	1.51-01	1.66-01	1.81-01	1.96-01
340	VB	7.62-04	9.46-04	1.46-03	2.34-03	3.25-03	4.13-03	5.26-03	6.34-03	7.68-03	8.78-03	9.88-03	1.10-02	1.24-02	1.38-02
350	VC	8.96-03	1.13-02	1.77-02	2.86-02	4.03-02	5.16-02	6.67-02	8.10-02	9.92-02	1.14-01	1.30-01	1.46-01	1.62-01	1.78-01
350	VB	5.81-04	7.30-04	1.15-03	1.85-03	2.61-03	3.35-03	4.33-03	5.25-03	6.43-03	7.39-03	8.50-03	9.61-03	1.07-02	1.23-02
360	VC	6.85-03	8.71-03	1.39-02	2.27-02	3.24-02	4.19-02	5.50-02	6.72-02	8.31-02	9.60-02	1.11-01	1.27-01	1.43-01	1.59-01
360	VB	4.45-04	5.66-04	9.01-04	1.47-03	2.11-03	2.72-03	3.57-03	4.37-03	5.40-03	6.24-03	7.35-03	8.50-03	9.65-03	1.08-02
370	VC	5.26-03	6.77-03	1.09-02	1.81-02	2.62-02	3.41-02	4.55-02	5.59-02	6.99-02	8.12-02	9.25-02	1.04-01	1.20-01	1.36-01
370	VB	3.42-04	4.41-04	7.12-04	1.18-03	1.71-03	2.22-03	2.96-03	3.64-03	4.55-03	5.29-03	6.23-03	7.17-03	8.11-03	9.05-03
380	VC	4.05-03	5.28-03	8.65-03	1.45-02	2.12-02	2.79-02	3.77-02	4.67-02	5.90-02	6.89-02	8.02-02	9.15-02	1.03-01	1.16-01
380	VB	2.65-04	3.45-04	5.64-04	9.45-04	1.39-03	1.82-03	2.46-03	3.05-03	3.85-03	4.49-03	5.33-03	6.17-03	7.01-03	7.85-03
390	VC	3.14-03	4.14-03	6.87-03	1.16-02	1.73-02	2.29-02	3.14-02	3.92-02	4.99-02	5.85-02	6.99-02	8.13-02	9.27-02	1.04-01
390	VB	2.05-04	2.71-04	4.49-04	7.61-04	1.13-03	1.50-03	2.05-03	2.56-03	3.26-03	3.83-03	4.53-03	5.23-03	5.93-03	6.63-03
400	VC	2.44-03	3.26-03	5.47-03	9.37-03	1.41-02	1.88-02	2.62-02	3.29-02	4.24-02	5.00-02	5.94-02	6.88-02	7.82-02	8.76-02
400	VB	1.60-04	2.14-04	3.59-04	6.14-04	9.24-04	1.24-03	1.72-03	2.16-03	2.78-03	3.28-03	3.80-03	4.32-03	4.84-03	5.36-03
410	VC	1.90-03	2.57-03	4.38-03	7.57-03	1.15-02	1.56-02	2.19-02	2.77-02	3.61-02	4.27-02	5.11-02	5.95-02	6.79-02	7.63-02
410	VB	1.25-04	1.69-04	2.88-04	4.98-04	7.58-04	1.02-03	1.44-03	1.82-03	2.37-03	2.81-03	3.25-03	3.69-03	4.13-03	4.57-03
420	VC	1.49-03	2.04-03	3.51-03	6.14-03	9.47-03	1.29-02	1.84-02	2.34-02	3.08-02	3.67-02	4.26-02	4.85-02	5.44-02	6.03-02
420	VB	9.82-05	1.34-04	2.31-04	4.04-04	6.24-04	8.48-04	1.21-03	1.54-03	2.03-03	2.41-03	2.80-03	3.19-03	3.58-03	3.97-03
430	VC	1.17-03	1.62-03	2.83-03	4.99-03	7.80-03	1.07-02	1.55-02	1.99-02	2.63-02	3.15-02	3.70-02	4.24-02	4.79-02	5.33-02
430	VB	7.74-05	1.07-04	1.87-04	3.30-04	5.15-04	7.05-04	1.02-03	1.31-03	1.74-03	2.08-03	2.42-03	2.76-03	3.10-03	3.44-03
440	VC	9.24-04	1.30-03	2.28-03	4.07-03	6.44-03	8.89-03	1.31-02	1.69-02	2.26-02	2.72-02	3.18-02	3.64-02	4.10-02	4.56-02
440	VB	6.11-05	8.57-05	1.51-04	2.69-04	4.26-04	5.88-04	8.65-04	1.12-03	1.49-03	1.80-03	2.11-03	2.42-03	2.73-03	3.04-03
450	VC	7.31-04	1.04-03	1.85-03	3.33-03	5.33-03	7.42-03	1.11-02	1.44-02	1.94-02	2.35-02	2.76-02	3.17-02	3.58-02	3.99-02
450	VB	4.85-05	6.87-05	1.23-04	2.21-04	3.53-04	4.92-04	7.34-04	9.52-04	1.29-03	1.56-03	1.83-03	2.10-03	2.37-03	2.64-03
460	VC	5.80-04	8.33-04	1.50-03	2.73-03	4.42-03	6.20-03	9.39-03	1.23-02	1.67-02	2.03-02	2.40-02	2.77-02	3.14-02	3.51-02
460	VB	3.85-05	5.53-05	9.98-05	1.81-04	2.94-04	4.12-04	6.24-04	8.14-04	1.11-03	1.35-03	1.59-03	1.83-03	2.07-03	2.31-03
470	VC	4.61-04	6.70-04	1.22-03	2.25-03	3.68-03	5.20-03	7.98-03	1.05-02	1.44-02	1.76-02	2.15-02	2.54-02	2.93-02	3.32-02
470	VB	3.07-05	4.46-05	8.15-05	1.49-04	2.45-04	3.46-04	5.31-04	6.98-04	9.62-04	1.17-03	1.41-03	1.65-03	1.89-03	2.13-03
480	VC	3.68-04	5.41-04	9.99-04	1.85-03	3.07-03	4.37-03	6.80-03	8.99-03	1.25-02	1.53-02	1.81-02	2.09-02	2.37-02	2.65-02
480	VB	2.46-05	3.61-05	6.66-05	1.23-04	2.05-04	2.92-04	4.53-04	6.00-04	8.34-04	1.02-03	1.26-03	1.50-03	1.74-03	1.98-03
490	VC	2.95-04	4.38-04	8.17-04	1.53-03	2.56-03	3.68-03	5.80-03	7.72-03	1.08-02	1.33-02	1.58-02	1.83-02	2.08-02	2.33-02
490	VB	1.97-05	2.93-05	5.47-05	1.02-04	1.71-04	2.46-04	3.88-04	5.16-04	7.24-04	8.91-04	1.08-03	1.26-03	1.44-03	1.62-03
500	VC	2.36-04	3.56-04	6.71-04	1.26-03	2.15-03	3.10-03	4.95-03	6.64-03	9.41-03	1.16-02	1.34-02	1.52-02	1.70-02	1.88-02
500	VB	1.58-05	2.38-05	4.49-05	8.47-05	1.44-04	2.08-04	3.32-04	4.45-04	6.31-04	7.79-04	9.27-04	1.07-03	1.25-03	1.43-03
510	VC	1.90-04	2.90-04	5.51-04	1.05-03	1.80-03	2.62-03	4.25-03	5.72-03	8.19-03	1.02-02	1.19-02	1.36-02	1.53-02	1.70-02
510	VB	1.28-05	1.94-05	3.70-05	7.04-05	1.21-04	1.76-04	2.85-04	3.84-04	5.50-04	6.82-04	8.14-04	9.46-04	1.08-03	1.26-03
520	VC	1.53-04	2.36-04	4.54-04	8.72-04	1.51-03	2.22-03	3.65-03	4.94-03	7.13-03	8.89-03	1.01-02	1.18-02	1.35-02	1.52-02
520	VB	1.03-05	1.59-05	3.06-05	5.87-05	1.02-04	1.50-04	2.46-04	3.33-04	4.80-04	5.98-04	7.16-04	8.34-04	9.50-04	1.07-03
530	VC	1.24-04	1.93-04	3.75-04	7.26-04	1.28-03	1.89-03	3.14-03	4.28-03	6.23-03	7.79-03	9.25-03	1.04-02	1.21-02	1.38-02
530	VB	8.35-06	1.30-05	2.53-05	4.90-05	8.60-05	1.27-04	2.12-04	2.88-04	4.20-04	5.26-04	6.32-04	7.38-04	8.44-04	9.50-04
540	VC	1.00-04	1.58-04	3.10-04	6.06-04	1.08-03	1.60-03	2.70-03	3.70-03	5.44-03	6.84-03	8.24-03	9.64-03	1.07-02	1.24-02
540	VB	6.78-06	1.07-05	2.10-05	4.10-05	7.27-05	1.08-04	1.83-04	2.50-04	3.68-04	4.63-04	5.60-04	6.57-04	7.54-04	8.51-04
550	VC	8.14-05	1.30-04	2.57-04	5.07-04	9.10-04	1.37-03	2.33-03	3.22-03	4.77-03	6.02-03	7.27-03	8.52-03	9.77-03	1.07-02
550	VB	5.51-05	8.80-05	1.74-05	3.43-05	6.16-05	9.25-05	1.58-04	2.18-04	3.23-04	4.08-04	4.93-04	5.78-04	6.63-04	7.48-04
560	VC	6.62-05	1.07-04	2.14-04	4.24-04	7.71-04	1.16-03	2.02-03	2.79-03	4.18-03	5.30-03	6.42-03	7.54-03	8.66-03	9.78-03
560	VB	4.50-06	7.26-06	1.45-05	2.88-05	5.23-05	7.91-05	1.37-04	1.90-04	2.84-04	3.60-04	4.45-04	5.30-04	6.15-04	7.00-04
570	VC	5.39-05	8.82-05	1.78-04	3.56-04	6.54-04	9.95-04	1.75-03	2.43-03	3.67-03	4.67-03	5.67-03	6.67-03	7.67-03	8.67-03
570	VB	3.67-06	6.00-06	1.21-05	2.42-05	4.45-05	6.77-05	1.19-04	1.66-04	2.50-04	3.18-04	3.86-04	4.54-04	5.22-04	5.90-04
580	VC	4.41-05	7.28-05	1.48-04	2.99-04	5.56-04	8.51-04	1.51-03	2.12-03	3.23-03	4.13-03	5.03-03	5.93-03	6.83-03	7.73-03
580	VB	3.01-06	4.97-06	1.01-05	2.04-05	3.79-05	5.81-05	1.03-04	1.45-						

Высота, км	Затраты	Фиксированный уровень солнечной активности $F_{10.7}$ , $10^{-22}$ Вт/(м <sup>2</sup> ·Гц)									
		65	75	100	125	150	175	200	225	250	275
600	VC	2.96-05	5.00-05	1.04-04	2.13-04	4.03-04	6.26-04	1.14-03	1.62-03	2.51-03	3.23-03
600	VB	2.02-06	3.43-06	7.11-06	1.46-05	2.76-05	4.29-05	7.82-05	1.11-04	1.72-04	2.21-04
610	VC	2.59-05	4.54-05	9.39-05	1.92-04	3.63-04	5.54-04	1.03-03	1.44-03	2.27-03	2.89-03
610	VB	1.78-06	3.12-06	6.44-06	1.32-05	2.49-05	3.80-05	7.06-05	9.86-05	1.56-04	1.98-04
620	VC	2.39-05	4.03-05	8.29-05	1.69-04	3.19-04	4.95-04	9.04-04	1.28-03	2.01-03	2.59-03
620	VB	1.64-06	2.77-06	5.70-06	1.16-05	2.19-05	3.40-05	6.22-05	8.82-05	1.38-04	1.78-04
630	VC	2.20-05	3.60-05	7.38-05	1.49-04	2.81-04	4.43-04	7.97-04	1.15-03	1.78-03	2.33-03
630	VB	1.52-06	2.48-06	5.09-06	1.03-05	1.94-05	3.06-05	5.49-05	7.91-05	1.23-04	1.61-04
640	VC	2.04-05	3.23-05	6.61-05	1.33-04	2.49-04	3.98-04	7.06-04	1.03-03	1.53-03	2.10-03
640	VB	1.41-06	2.23-06	4.57-06	9.18-06	1.72-05	2.75-05	4.87-05	7.11-05	1.09-04	1.45-04
650	VC	1.89-05	2.92-05	5.96-05	1.19-04	2.22-04	3.59-04	6.27-04	9.26-04	1.41-03	1.90-03
650	VB	1.31-06	2.02-06	4.12-06	8.24-06	1.54-05	2.49-05	4.34-05	6.41-05	9.77-05	1.31-04
660	VC	1.76-05	2.65-05	5.39-05	1.07-04	1.99-04	3.24-04	5.59-04	8.34-04	1.26-03	1.71-03
660	VB	1.22-06	1.84-06	3.74-06	7.42-06	1.38-05	2.25-05	3.88-05	5.79-05	8.75-05	1.19-04
670	VC	1.63-05	2.41-05	4.89-05	9.65-05	1.79-04	2.94-04	4.99-04	7.52-04	1.13-03	1.55-03
670	VB	1.14-06	1.68-06	3.40-06	6.71-06	1.24-05	2.04-05	3.47-05	5.23-05	7.84-05	1.08-04
680	VC	1.52-05	2.20-05	4.46-05	8.74-05	1.61-04	2.67-04	4.48-04	6.80-04	1.01-03	1.40-03
680	VB	1.06-06	1.54-06	3.11-06	6.09-06	1.12-05	1.86-05	3.12-05	4.74-05	7.05-05	9.78-05
690	VC	1.42-05	2.02-05	4.08-05	7.94-05	1.46-04	2.43-04	4.02-04	6.16-04	9.09-04	1.27-03
690	VB	9.90-07	1.41-06	2.85-06	5.54-06	1.02-05	1.69-05	2.81-05	4.30-05	6.35-05	8.88-05
700	VC	1.32-05	1.86-05	3.74-05	7.24-05	1.32-04	2.21-04	3.62-04	5.58-04	8.18-04	1.15-03
700	VB	9.26-07	1.30-06	2.61-06	5.06-06	9.24-06	1.55-05	2.53-05	3.91-05	5.72-05	8.08-05
710	VC	1.23-05	1.71-05	3.43-05	6.61-05	1.20-04	2.02-04	3.27-04	5.07-04	7.37-04	1.05-03
710	VB	8.70-07	1.20-06	2.41-06	4.63-06	8.41-06	1.42-05	2.29-05	3.55-05	5.17-05	7.35-05
720	VC	1.15-05	1.58-05	3.16-05	6.05-05	1.09-04	1.85-04	2.96-04	4.61-04	6.66-04	9.53-04
720	VB	8.13-07	1.11-06	2.23-06	4.26-06	7.68-06	1.30-05	2.08-05	3.24-05	4.68-05	6.70-05
730	VC	1.08-05	1.46-05	2.92-05	5.56-05	9.98-05	1.69-04	2.68-04	4.20-04	6.02-04	8.67-04
730	VB	7.60-07	1.03-06	2.06-06	3.92-06	7.03-06	1.19-05	1.89-05	2.95-05	4.24-05	6.11-05
740	VC	1.01-05	1.36-05	2.70-05	5.11-05	9.13-05	1.55-04	2.43-04	3.83-04	5.45-04	7.90-04
740	VB	7.17-07	9.65-07	1.91-06	3.61-06	6.44-06	1.10-05	1.72-05	2.70-05	3.85-05	5.57-05
750	VC	9.49-06	1.26-05	2.51-05	4.71-05	8.37-05	1.43-04	2.21-04	3.50-04	4.94-04	7.20-04
750	VB	6.77-07	8.94-07	1.78-06	3.34-06	5.92-06	1.01-05	1.56-05	2.47-05	3.49-05	5.09-05
760	VC	8.91-06	1.18-05	2.33-05	4.35-05	7.69-05	1.31-04	2.02-04	3.19-04	4.49-04	6.57-04
760	VB	6.31-07	8.35-07	1.65-06	3.08-06	5.45-06	9.30-06	1.43-05	2.26-05	3.18-05	4.65-05
770	VC	8.37-06	1.10-05	2.17-05	4.02-05	7.07-05	1.21-04	1.84-04	2.92-04	4.08-04	6.00-04
770	VB	6.01-07	7.83-07	1.54-06	2.85-06	5.02-06	8.59-06	1.31-05	2.08-05	2.90-05	4.26-05
780	VC	7.87-06	1.02-05	2.02-05	3.73-05	6.52-05	1.12-04	1.68-04	2.68-04	3.71-04	5.48-04
780	VB	5.62-07	7.28-07	1.43-06	2.66-06	4.63-06	7.94-06	1.20-05	1.91-05	2.64-05	3.90-05
790	VC	7.41-06	9.57-06	1.88-05	3.46-05	6.01-05	1.03-04	1.54-04	2.46-04	3.38-04	5.01-04
790	VB	5.30-07	6.88-07	1.34-06	2.47-06	4.29-06	7.35-06	1.10-05	1.75-05	2.41-05	3.57-05
800	VC	6.97-06	8.96-06	1.76-05	3.21-05	5.56-05	9.53-05	1.41-04	2.26-04	3.09-04	4.59-04
800	VB	5.06-07	6.42-07	1.26-05	2.30-06	3.97-06	6.81-06	1.01-05	1.61-05	2.20-05	3.28-05
810	VC	6.57-06	8.40-06	1.65-05	2.99-05	5.14-05	8.82-05	1.29-04	2.07-04	2.82-04	4.20-04
810	VB	4.71-07	6.01-07	1.18-06	2.14-06	3.68-06	6.32-06	9.26-06	1.48-05	2.02-05	3.01-05
820	VC	6.19-06	7.89-06	1.54-05	2.78-05	4.76-05	8.17-05	1.19-04	1.91-04	2.58-04	3.85-04
820	VB	4.50-07	5.67-07	1.11-06	2.00-06	3.42-06	5.87-06	8.52-06	1.37-05	1.85-05	2.76-05
830	VC	5.85-06	7.41-06	1.44-05	2.59-05	4.42-05	7.58-05	1.09-04	1.76-04	2.36-04	3.53-04
830	VB	4.19-07	5.35-07	1.04-06	1.86-06	3.18-06	5.45-06	7.86-06	1.26-05	1.70-05	2.54-05
840	VC	5.52-06	6.97-06	1.36-05	2.42-05	4.10-05	7.04-05	1.01-04	1.62-04	2.16-04	3.24-04
840	VB	3.99-07	5.06-07	9.74-07	1.75-06	2.96-06	5.07-06	7.25-06	1.17-05	1.56-05	2.34-05
850	VC	5.21-06	6.56-06	1.27-05	2.26-05	3.82-05	6.54-05	9.27-05	1.49-04	1.98-04	2.98-04
850	VB	3.75-07	4.76-07	9.20-07	1.64-06	2.76-06	4.73-06	6.70-06	1.08-05	1.43-05	2.15-05
860	VC	4.92-05	6.19-06	1.20-05	2.12-05	3.55-05	6.09-05	8.56-05	1.38-04	1.82-04	2.74-04
860	VB	3.59-07	4.50-07	8.70-07	1.53-05	2.57-05	4.41-05	6.19-06	9.96-06	1.32-05	1.98-05
870	VC	4.66-06	5.83-06	1.13-05	1.98-05	3.31-05	5.67-05	7.90-05	1.27-04	1.67-04	2.52-04
870	VB	3.42-07	4.29-07	8.19-07	1.43-06	2.40-06	4.11-06	5.73-06	9.23-06	1.21-05	1.83-05
880	VC	4.41-05	5.51-06	1.06-05	1.85-05	3.09-05	5.28-05	7.31-05	1.18-04	1.54-04	2.32-04
880	VB	3.24-07	4.04-07	7.73-07	1.35-06	2.25-06	3.84-06	5.31-06	8.55-06	1.12-05	1.68-05
890	VC	4.17-06	5.20-06	1.00-05	1.74-05	2.88-05	4.92-05	6.76-05	1.09-04	1.41-04	2.13-04
890	VB	3.08-07	3.80-07	7.28-07	1.27-06	2.10-06	3.59-06	4.92-06	7.93-06	1.03-05	1.55-05
900	VC	3.96-06	4.92-06	9.45-05	1.64-05	2.69-05	4.59-05	6.26-05	1.01-04	1.30-04	1.97-04
900	VB	2.89-07	3.64-07	6.92-07	1.19-05	1.96-06	3.35-05	4.57-06	7.35-06	9.49-06	1.43-05
910	VC	3.75-05	4.66-06	8.93-06	1.54-05	2.52-05	4.29-05	5.81-05	9.34-05	1.20-04	1.81-04
910	VB	2.78-07	3.42-07	6.53-07	1.13-06	1.84-06	3.14-06	4.25-06	6.83-06	8.77-06	1.33-05
920	VC	3.55-06	4.41-06	8.43-05	1.45-05	2.36-05	4.01-05	5.39-05	8.66-05	1.11-04	1.67-04
920	VB	2.62-07	3.24-07	6.21-07	1.06-06	1.72-06	2.94-06	3.95-06	6.35-06	8.10-06	1.22-05
930	VC	3.37-06	4.18-06	7.98-05	1.35-05	2.21-05	3.75-05	5.00-05	8.04-05	1.02-04	1.54-04



Высота, км	Загрязн.	Фиксированный уровень солнечной активности $F_{10.7} 10^{-22}$ Вт/(м <sup>2</sup> ·Гц)									
		65	75	100	125	150	175	200	225	250	275
930	VB	2.46-07	3.13-07	5.91-07	1.00-06	1.62-06	2.76-06	3.67-06	5.90-06	7.49-06	1.13-05
940	VC	3.20-06	3.97-06	7.56-06	1.28-05	2.07-05	3.51-05	4.65-05	7.47-05	9.43-05	1.43-04
940	VB	2.37-07	2.89-07	5.57-07	9.43-07	1.52-06	2.59-06	3.42-06	5.49-06	6.94-06	1.05-05
950	VC	3.04-06	3.76-06	7.15-06	1.21-05	1.94-05	3.29-05	4.32-05	6.94-05	8.72-05	1.32-04
950	VB	2.27-07	2.78-07	5.30-07	8.88-07	1.43-06	2.42-06	3.19-06	5.12-06	6.42-06	9.71-06
960	VC	2.89-06	3.58-06	6.78-06	1.14-05	1.82-05	3.08-05	4.02-05	6.45-05	8.06-05	1.22-04
960	VB	2.17-07	2.68-07	5.06-07	8.46-07	1.35-06	2.28-06	2.97-06	4.77-06	5.96-06	9.00-06
970	VC	2.75-06	3.39-06	6.43-06	1.09-05	1.71-05	2.89-05	3.75-05	6.00-05	7.46-05	1.13-04
970	VB	2.03-07	2.52-07	4.76-07	7.97-07	1.27-06	2.14-06	2.77-06	4.44-06	5.52-06	8.34-06
980	VC	2.61-06	3.23-06	6.10-06	1.02-05	1.61-05	2.71-05	3.49-05	5.59-05	6.91-05	1.04-04
980	VB	1.93-07	2.42-07	4.55-07	7.55-07	1.19-06	2.01-06	2.59-06	4.14-06	5.13-06	7.73-06
990	VC	2.48-06	3.07-06	5.79-06	9.60-06	1.51-05	2.55-05	3.26-05	5.20-05	6.41-05	9.66-05
990	VB	1.82-07	2.33-07	4.29-07	7.17-07	1.13-06	1.90-06	2.42-06	3.87-06	4.77-06	7.18-06
1000	VC	2.37-06	2.92-06	5.50-06	9.08-06	1.42-05	2.39-05	3.04-05	4.85-05	5.94-05	8.95-05
1000	VB	1.77-07	2.22-07	4.15-07	6.77-07	1.06-06	1.78-06	2.27-06	3.61-06	4.43-06	6.66-06
1010	VC	2.25-06	2.78-06	5.21-06	8.59-06	1.34-05	2.25-05	2.84-05	4.52-05	5.51-05	8.29-05
1010	VB	1.71-07	2.11-07	3.93-07	6.42-07	1.00-06	1.68-06	2.12-06	3.37-06	4.12-06	6.19-06
1020	VC	2.15-06	2.65-06	4.98-06	8.13-06	1.26-05	2.12-05	2.65-05	4.22-05	5.12-05	7.69-05
1020	VB	1.61-07	1.98-07	3.75-07	6.10-07	9.49-07	1.59-06	1.98-06	3.16-06	3.83-06	5.75-06
1030	VC	2.05-06	2.52-06	4.73-06	7.70-05	1.19-05	1.99-05	2.48-05	3.94-05	4.76-05	7.13-05
1030	VB	1.57-07	1.93-07	3.53-07	5.81-07	8.94-07	1.49-06	1.86-06	2.96-06	3.57-06	5.34-06
1040	VC	1.95-06	2.41-06	4.51-06	7.29-06	1.12-05	1.87-05	2.32-05	3.68-05	4.42-05	6.62-05
1040	VB	1.51-07	1.82-07	3.42-07	5.46-07	8.46-07	1.41-06	1.75-06	2.76-06	3.32-06	4.97-06
1050	VC	1.86-06	2.30-06	4.29-06	6.92-06	1.06-05	1.76-05	2.17-05	3.44-05	4.11-05	6.15-05
1050	VB	1.42-07	1.71-07	3.24-07	5.24-07	8.03-07	1.33-06	1.64-06	2.59-06	3.09-06	4.62-06
1060	VC	1.78-06	2.20-06	4.09-06	6.56-06	1.00-05	1.66-05	2.03-05	3.21-05	3.83-05	5.71-05
1060	VB	1.36-07	1.66-07	3.13-07	4.95-07	7.60-07	1.25-06	1.53-06	2.42-06	2.88-06	4.31-06
1070	VC	1.69-06	2.10-06	3.90-06	6.23-06	9.47-06	1.57-05	1.91-05	3.01-05	3.66-05	5.31-05
1070	VB	1.31-07	1.61-07	2.94-07	4.71-07	7.17-07	1.19-06	1.44-06	2.27-06	2.69-06	4.01-06
1080	VC	1.62-06	2.00-06	3.71-06	5.91-06	8.96-06	1.48-05	1.79-05	2.81-05	3.32-05	4.94-05
1080	VB	1.26-07	1.51-07	2.84-07	4.50-07	6.82-07	1.13-06	1.35-06	2.13-06	2.52-06	3.74-06
1090	VC	1.54-06	1.91-06	3.54-06	5.61-06	8.47-06	1.40-05	1.68-05	2.63-05	3.09-05	4.59-05
1090	VB	1.20-07	1.51-07	2.68-07	4.29-07	6.42-07	1.06-06	1.27-06	2.00-06	2.34-06	3.48-06
1100	VC	1.48-06	1.83-06	3.38-06	5.34-06	8.02-06	1.32-05	1.57-05	2.47-05	2.88-05	4.27-05
1100	VB	1.15-07	1.42-07	2.57-07	4.09-07	6.10-07	1.01-06	1.20-06	1.87-06	2.20-06	3.24-06
1110	VC	1.41-06	1.75-06	3.23-06	5.07-06	7.59-06	1.24-05	1.48-05	2.31-05	2.69-05	3.98-05
1110	VB	1.07-07	1.36-07	2.46-07	3.85-07	5.81-07	9.55-07	1.13-06	1.76-06	2.05-06	3.03-06
1120	VC	1.35-06	1.67-06	3.09-06	4.83-06	7.19-06	1.18-05	1.39-05	2.17-05	2.51-05	3.70-05
1120	VB	1.07-07	1.31-07	2.37-07	3.69-07	5.46-07	8.99-07	1.06-05	1.65-06	1.92-06	2.83-06
1130	VC	1.28-06	1.60-06	2.95-06	4.59-06	6.81-06	1.11-05	1.30-05	2.03-05	2.34-05	3.45-05
1130	VB	9.63-08	1.26-07	2.27-07	3.53-07	5.24-07	8.51-07	9.95-07	1.55-06	1.79-06	2.64-06
1140	VC	1.23-06	1.53-06	2.82-06	4.37-06	6.46-06	1.05-05	1.23-05	1.91-05	2.19-05	3.22-05
1140	VB	9.63-08	1.20-07	2.17-07	3.38-07	4.95-07	8.03-07	9.43-07	1.46-06	1.68-06	2.46-06
1150	VC	1.18-06	1.47-06	2.70-06	4.16-06	6.12-06	9.94-06	1.15-05	1.79-05	2.05-05	3.00-05
1150	VB	9.10-08	1.20-07	2.11-07	3.24-07	4.71-07	7.68-07	8.88-07	1.38-06	1.57-06	2.30-06
1160	VC	1.13-06	1.41-06	2.58-06	3.97-06	5.81-06	9.42-06	1.09-05	1.68-05	1.91-05	2.80-05
1160	VB	8.56-08	1.07-07	2.03-07	3.08-07	4.50-07	7.28-07	8.35-07	1.30-06	1.47-06	2.15-06
1170	VC	1.08-06	1.35-06	2.47-06	3.78-06	5.51-06	8.91-06	1.02-05	1.58-05	1.79-05	2.61-05
1170	VB	8.56-08	1.07-07	1.93-07	2.89-07	4.29-07	6.88-07	7.92-07	1.22-06	1.38-06	2.01-06
1180	VC	1.03-06	1.30-06	2.37-06	3.61-05	5.24-06	8.44-06	9.62-06	1.48-05	1.68-05	2.44-05
1180	VB	8.03-08	1.02-07	1.82-07	2.78-07	4.09-07	6.53-07	7.44-07	1.15-06	1.30-06	1.88-06
1190	VC	9.85-07	1.24-05	2.27-05	3.44-06	4.97-06	8.00-06	9.07-06	1.40-05	1.57-05	2.27-05
1190	VB	7.49-08	9.63-08	1.77-07	2.68-07	3.85-07	6.21-07	7.06-07	1.08-06	1.22-06	1.76-06
1200	VC	9.49-07	1.19-06	2.17-05	3.28-06	4.73-06	7.58-06	8.55-06	1.31-05	1.47-05	2.12-05
1200	VB	7.49-08	9.63-08	1.71-07	2.57-07	3.64-07	5.91-07	6.84-07	1.02-06	1.14-06	1.65-06
1210	VC	9.10-07	1.15-05	2.08-05	3.13-06	4.49-06	7.19-06	8.06-06	1.23-05	1.38-05	1.99-05
1210	VB	7.49-08	9.10-08	1.61-07	2.46-07	3.53-07	5.57-07	6.26-07	9.65-07	1.07-06	1.54-06
1220	VC	8.70-07	1.10-03	1.99-05	2.99-06	4.27-06	6.82-06	7.61-06	1.16-05	1.29-05	1.86-05
1220	VB	6.96-08	8.56-08	1.57-07	2.37-07	3.33-07	5.35-07	5.95-07	9.04-07	1.01-06	1.44-06
1230	VC	8.35-07	1.05-03	1.91-05	2.85-06	4.06-06	6.47-06	7.18-06	1.09-05	1.21-05	1.73-05
1230	VB	6.42-08	8.56-08	1.51-07	2.27-07	3.24-07	5.06-07	5.62-07	8.59-07	9.43-07	1.35-06
1240	VC	8.03-07	1.01-06	1.83-06	2.73-06	3.87-06	6.14-06	6.78-06	1.03-05	1.13-05	1.62-05
1240	VB	6.42-08	8.03-08	1.46-07	2.17-07	3.02-07	4.82-07	5.30-07	8.03-07	8.89-07	1.27-06
1250	VC	7.73-07	9.74-07	1.76-06	2.60-06	3.68-06	5.83-06	6.40-06	9.71-06	1.07-05	1.52-05
1250	VB	6.42-08	7.49-08	1.42-07	2.03-07	2.89-07	4.60-07	5.06-07	7.60-07	8.35-07	1.19-06
1260	VC	7.39-07	9.31-07	1.69-06	2.50-06	3.50-06	5.53-06	6.05-06	9.15-06	1.00-05	1.42-05

Высота, км	Затраты	Фиксированный уровень солнечной активности $F_{10, 10}^{-22}$ Вт/(м <sup>2</sup> ·Гц)									
		65	75	100	125	150	175	200	225	250	275
1260	VB	6.02-08	7.49-08	1.36-07	1.93-07	2.78-07	4.39-07	4.76-07	7.17-07	7.83-07	1.11-06
1270	VC	7.06-07	8.99-07	1.62-06	2.38-06	3.34-06	5.26-06	5.72-06	8.63-06	9.39-06	1.33-05
1270	VB	5.49-08	7.49-08	1.31-07	1.87-07	2.62-07	4.19-07	4.60-07	6.82-07	7.39-07	1.05-06
1280	VC	6.77-07	8.70-07	1.55-06	2.28-06	3.18-06	5.00-06	5.41-06	8.14-06	8.81-06	1.25-05
1280	VB	5.49-08	6.96-08	1.26-07	1.82-07	2.52-07	3.99-07	4.29-07	6.42-07	6.97-07	9.85-07
1290	VC	6.53-07	8.29-07	1.49-06	2.18-06	3.03-06	4.75-06	5.12-06	7.68-06	8.28-06	1.17-05
1290	VB	5.49-08	6.42-08	1.20-07	1.71-07	2.42-07	3.75-07	4.09-07	6.10-07	6.53-07	9.20-07
1300	VC	6.21-07	8.03-07	1.43-06	2.09-06	2.89-06	4.52-06	4.84-06	7.25-06	7.79-06	1.09-05
1300	VB	5.49-08	6.42-08	1.20-07	1.66-07	2.33-07	3.59-07	3.85-07	5.73-07	6.15-07	8.70-07
1310	VC	6.01-07	7.73-07	1.38-06	2.00-06	2.76-06	4.30-06	4.58-06	6.84-06	7.32-06	1.02-05
1310	VB	5.08-08	6.42-08	1.07-07	1.61-07	2.22-07	3.42-07	3.64-07	5.46-07	5.81-07	8.13-07
1320	VC	5.81-07	7.39-07	1.33-06	1.91-06	2.63-06	4.09-06	4.34-06	6.46-06	6.89-06	9.61-06
1320	VB	5.08-08	6.02-08	1.07-07	1.51-07	2.11-07	3.28-07	3.42-07	5.15-07	5.46-07	7.60-07
1330	VC	5.57-07	7.12-07	1.27-06	1.83-06	2.51-06	3.89-06	4.10-06	6.10-06	6.48-06	9.01-06
1330	VB	4.55-08	6.02-08	1.02-07	1.51-07	2.03-07	3.13-07	3.28-07	4.90-07	5.15-07	7.17-07
1340	VC	5.35-07	6.88-07	1.23-06	1.76-06	2.40-06	3.70-06	3.89-06	5.76-06	6.10-06	8.46-06
1340	VB	4.55-08	5.49-08	9.63-08	1.42-07	1.93-07	3.02-07	3.13-07	4.60-07	4.90-07	6.77-07
1350	VC	5.15-07	6.64-07	1.18-06	1.68-06	2.29-06	3.53-06	3.68-06	5.45-06	5.74-06	7.93-06
1350	VB	4.55-08	5.49-08	9.63-08	1.42-07	1.82-07	2.84-07	2.94-07	4.39-07	4.60-07	6.31-07
1360	VC	4.95-07	6.37-07	1.14-06	1.61-06	2.18-06	3.36-06	3.49-06	4.15-06	4.41-06	6.15-06
1360	VB	4.55-08	5.49-08	9.10-08	1.31-07	1.77-07	2.68-07	2.78-07	4.15-07	4.33-07	6.01-07
1370	VC	4.71-07	6.10-07	1.09-06	1.54-06	2.09-06	3.20-06	3.31-06	4.87-06	5.09-06	6.99-06
1370	VB	4.55-08	5.49-08	8.56-08	1.31-07	1.71-07	2.57-07	2.68-07	3.93-07	4.09-07	5.62-07
1380	VC	4.55-07	5.91-07	1.05-06	1.48-06	1.99-06	3.05-06	3.14-06	4.60-06	4.80-06	6.57-06
1380	VB	4.01-08	5.08-08	8.56-08	1.20-07	1.61-07	2.46-07	2.57-07	4.75-07	3.85-07	5.30-07
1390	VC	4.39-07	5.67-07	1.01-06	1.42-06	1.91-06	2.91-06	2.98-06	4.36-06	4.53-06	6.17-06
1390	VB	4.01-08	5.08-08	8.56-08	1.20-07	1.57-07	2.37-07	2.42-07	3.53-07	3.64-07	5.00-07
1400	VC	4.19-07	5.51-07	9.74-07	1.36-06	1.82-06	2.77-06	2.83-06	4.12-06	4.27-06	5.80-06
1400	VB	3.48-08	4.56-08	8.03-08	1.15-07	1.51-07	2.27-07	2.33-07	3.33-07	3.42-07	4.71-07
1410	VC	4.09-07	5.30-07	9.37-07	1.31-06	1.74-06	2.64-06	2.69-06	3.91-06	4.03-06	5.45-06
1410	VB	3.48-08	4.56-08	7.49-08	1.07-07	1.42-07	2.17-07	2.17-07	3.18-07	3.28-07	4.39-07
1420	VC	3.93-07	5.16-07	8.99-07	1.26-06	1.67-06	2.52-06	2.53-06	3.69-06	3.80-06	5.13-06
1420	VB	3.48-08	4.56-08	7.49-08	1.02-07	1.42-07	2.03-07	2.11-07	3.02-07	3.13-07	4.19-07
1430	VC	3.75-07	4.95-07	8.70-07	1.21-06	1.60-06	2.41-06	2.42-06	3.50-06	3.59-06	4.82-06
1430	VB	3.48-08	4.56-08	7.49-08	9.63-08	1.31-07	1.93-07	1.98-07	2.89-07	2.89-07	3.93-07
1440	VC	3.64-07	4.76-07	8.35-07	1.16-06	1.53-06	2.30-06	2.30-06	3.32-06	3.38-06	4.53-06
1440	VB	3.48-08	4.56-08	6.96-08	9.63-08	1.31-07	1.87-07	1.87-07	2.68-07	2.78-07	3.69-07
1450	VC	3.48-07	4.60-07	8.08-07	1.11-06	1.48-06	2.20-06	2.18-06	3.15-06	3.20-06	4.26-06
1450	VB	3.48-08	4.01-08	6.42-08	9.10-08	1.20-07	1.82-07	1.82-07	2.57-07	2.62-07	3.48-07
1460	VC	3.38-07	4.44-07	7.83-07	1.07-06	1.40-06	2.09-06	2.08-06	2.97-06	3.02-06	4.01-06
1460	VB	3.48-08	4.01-08	6.42-08	8.56-08	1.20-07	1.71-07	1.71-07	2.46-07	2.46-07	3.33-07
1470	VC	3.24-07	4.29-07	7.49-07	1.03-06	1.34-06	2.00-06	1.98-06	2.83-06	2.85-06	3.78-06
1470	VB	2.94-08	4.01-08	6.42-08	8.56-08	1.07-07	1.66-07	1.61-07	2.37-07	2.37-07	3.13-07
1480	VC	3.13-07	4.19-07	7.28-07	9.85-07	1.28-06	1.91-06	1.88-06	2.68-06	2.70-06	3.55-06
1480	VB	2.94-08	3.48-08	6.42-08	8.56-08	1.07-07	1.61-07	1.57-07	2.22-07	2.27-07	2.89-07
1490	VC	3.02-07	4.04-07	6.97-07	9.55-07	1.23-06	1.83-06	1.79-06	2.54-06	2.55-06	3.35-06
1490	VB	2.94-08	3.48-08	6.02-08	8.03-08	1.02-07	1.51-07	1.51-07	2.11-07	2.11-07	2.78-07
1500	VC	2.89-07	3.85-07	6.77-07	9.10-07	1.18-06	1.75-06	1.70-06	2.41-06	2.41-06	3.16-06
1500	VB	2.27-08	3.48-08	5.49-08	7.49-08	9.63-08	1.46-07	1.42-07	1.98-07	1.98-07	2.57-07

Примечания к табл. 3—8:

1. Число со знаком, стоящее после значения параметра, является показателем степени десяти — множителя значения параметра.

2. В таблицах приняты следующие обозначения:

GC — средние затраты топлива за сутки ( $\Delta G_{\text{тн}}^c$ );GB — средние затраты топлива за виток ( $\Delta G_{\text{вн}}^a$ );VC — средние затраты характеристической скорости за сутки ( $\Delta V_{\text{хр}}^c$ );VB — средние затраты характеристической скорости за виток ( $\Delta V_{\text{хр}}^a$ ).

Угол входа — 0,2 град

Н, км	DVT, м/с	VBX, м/с	ТЕТА, ГРАД	Н, км	DVT, м/с	VBX, м/с	ТЕТА, ГРАД
110.0	18.475	7831.515	0.00	810.0	196.240	8044.907	0.00
120.0	13.784	7842.269	0.00	820.0	198.751	8047.560	0.00
130.0	14.217	7847.855	0.00	830.0	201.254	8050.209	0.00
140.0	15.928	7852.149	0.00	840.0	203.752	8052.852	0.00
150.0	18.145	7855.923	0.00	850.0	206.244	8055.491	0.00
160.0	20.612	7859.434	0.00	860.0	208.729	8058.125	0.00
170.0	23.218	7862.791	0.00	870.0	211.208	8060.754	0.00
180.0	25.909	7866.051	0.00	880.0	213.681	8063.379	0.00
190.0	28.652	7869.244	0.00	890.0	216.148	8065.999	0.00
200.0	31.431	7872.388	0.00	900.0	218.609	8068.614	0.00
210.0	34.233	7875.495	0.00	910.0	221.064	8071.224	0.00
220.0	37.051	7878.573	0.00	920.0	223.513	8073.830	0.00
230.0	39.879	7881.628	0.00	930.0	225.955	8076.431	0.00
240.0	42.713	7884.663	0.00	940.0	228.392	8079.027	0.00
250.0	45.551	7887.680	0.00	950.0	230.823	8081.619	0.00
260.0	48.391	7890.683	0.00	960.0	233.248	8084.206	0.00
270.0	51.230	7893.673	0.00	970.0	235.667	8086.789	0.00
280.0	54.068	7896.651	0.00	980.0	238.079	8089.366	0.00
290.0	56.903	7899.618	0.00	990.0	240.486	8091.940	0.00
300.0	59.736	7902.575	0.00	1000.0	242.888	8094.509	0.00
310.0	62.565	7905.523	0.00	1010.0	245.283	8097.073	0.00
320.0	65.389	7908.462	0.00	1020.0	247.672	8099.632	0.00
330.0	68.209	7911.392	0.00	1030.0	250.056	8102.187	0.00
340.0	71.024	7914.315	0.00	1040.0	252.433	8104.738	0.00
350.0	73.834	7917.230	0.00	1050.0	254.805	8107.284	0.00
360.0	76.638	7920.137	0.00	1060.0	257.172	8109.826	0.00
370.0	79.437	7923.037	0.00	1070.0	259.532	8112.363	0.00
380.0	82.230	7925.930	0.00	1080.0	261.887	8114.896	0.00
390.0	85.017	7928.817	0.00	1090.0	264.235	8117.424	0.00
400.0	87.798	7931.697	0.00	1100.0	266.579	8119.948	0.00
410.0	90.572	7934.570	0.00	1110.0	268.916	8122.467	0.00
420.0	93.341	7937.437	0.00	1120.0	271.248	8124.982	0.00
430.0	96.103	7940.297	0.00	1130.0	273.574	8127.492	0.00
440.0	98.859	7943.152	0.00	1140.0	275.895	8129.999	0.00
450.0	101.608	7946.000	0.00	1150.0	278.210	8132.500	0.00
460.0	104.351	7948.843	0.00	1160.0	280.519	8134.998	0.00
470.0	107.087	7951.679	0.00	1170.0	282.823	8137.491	0.00
480.0	109.817	7954.510	0.00	1180.0	285.121	8139.980	0.00
490.0	112.540	7957.335	0.00	1190.0	287.414	8142.464	0.00
500.0	115.257	7960.154	0.00	1200.0	289.701	8144.944	0.00
510.0	117.967	7962.968	0.00	1210.0	291.982	8147.420	0.00
520.0	120.671	7965.776	0.00	1220.0	294.258	8149.892	0.00
530.0	123.368	7968.578	0.00	1230.0	296.529	8152.359	0.00
540.0	126.059	7971.375	0.00	1240.0	298.794	8154.822	0.00
550.0	128.742	7974.166	0.00	1250.0	301.054	8157.280	0.00
560.0	131.420	7976.952	0.00	1260.0	303.308	8159.735	0.00
570.0	134.090	7979.732	0.00	1270.0	305.557	8162.185	0.00
580.0	136.755	7982.507	0.00	1280.0	307.801	8164.631	0.00
590.0	139.412	7985.277	0.00	1290.0	310.039	8167.073	0.00
600.0	142.063	7988.041	0.00	1300.0	312.272	8169.511	0.00
610.0	144.708	7990.800	0.00	1310.0	314.499	8171.944	0.00
620.0	147.345	7993.554	0.00	1320.0	316.721	8174.373	0.00
630.0	149.977	7996.302	0.00	1330.0	318.938	8176.799	0.00
640.0	152.602	7999.046	0.00	1340.0	321.150	8179.220	0.00
650.0	155.220	8001.784	0.00	1350.0	323.356	8181.636	0.00
660.0	157.832	8004.517	0.00	1360.0	325.557	8184.049	0.00
670.0	160.437	8007.245	0.00	1370.0	327.753	8186.458	0.00
680.0	163.036	8009.967	0.00	1380.0	329.943	8188.862	0.00
690.0	165.629	8012.685	0.00	1390.0	332.129	8191.263	0.00
700.0	168.215	8015.398	0.00	1400.0	334.309	8193.659	0.00
710.0	170.794	8018.105	0.00	1410.0	336.484	8196.051	0.00
720.0	173.367	8020.808	0.00	1420.0	338.654	8198.439	0.00
730.0	175.934	8023.505	0.00	1430.0	340.819	8200.824	0.00
740.0	178.495	8026.198	0.00	1440.0	342.978	8203.204	0.00
750.0	181.049	8028.885	0.00	1450.0	345.133	8205.580	0.00
760.0	183.596	8031.568	0.00	1460.0	347.282	8207.952	0.00
770.0	185.138	8034.245	0.00	1470.0	349.427	8210.320	0.00
780.0	188.673	8036.918	0.00	1480.0	351.566	8212.684	0.00
790.0	191.202	8039.585	0.00	1490.0	353.701	8215.044	0.00
800.0	193.724	8042.249	0.00	1500.0	355.830	8217.400	0.00

## Угол входа — 0,3 град

Н, км	DVT, м/с	VBX, м/с	ТЕТА, ГРАД	Н, км	DVT, м/с	VBX, м/с	ТЕТА, ГРАД
110.0	37.662	7812.388	49.66	810.0	196.534	8044.642	0.00
120.0	23.434	7832.648	0.00	820.0	199.041	8047.299	0.00
130.0	20.668	7841.433	0.00	830.0	201.541	8049.951	0.00
140.0	20.776	7847.331	0.00	840.0	204.035	8052.598	0.00
150.0	22.030	7852.068	0.00	850.0	206.523	8055.241	0.00
160.0	23.854	7856.221	0.00	860.0	209.005	8057.878	0.00
170.0	26.001	7860.038	0.00	870.0	211.481	8060.511	0.00
180.0	28.347	7863.643	0.00	880.0	213.951	8063.138	0.00
190.0	30.822	7867.104	0.00	890.0	216.414	8065.761	0.00
200.0	33.387	7870.463	0.00	900.0	218.872	8068.379	0.00
210.0	36.013	7873.745	0.00	910.0	221.324	8070.993	0.00
220.0	38.684	7876.970	0.00	920.0	223.770	8073.601	0.00
230.0	41.389	7880.148	0.00	930.0	226.210	8076.205	0.00
240.0	44.117	7883.289	0.00	940.0	228.644	8078.804	0.00
250.0	46.863	7886.399	0.00	950.0	231.072	8081.399	0.00
260.0	49.621	7889.482	0.00	960.0	233.494	8083.989	0.00
270.0	52.390	7892.543	0.00	970.0	235.910	8086.574	0.00
280.0	55.164	7895.584	0.00	980.0	238.321	8089.154	0.00
290.0	57.943	7898.608	0.00	990.0	240.725	8091.730	0.00
300.0	60.725	7901.616	0.00	1000.0	243.124	8094.301	0.00
310.0	63.508	7904.610	0.00	1010.0	245.517	8096.868	0.00
320.0	66.291	7907.590	0.00	1020.0	247.904	8099.430	0.00
330.0	69.072	7910.559	0.00	1030.0	250.285	8101.987	0.00
340.0	71.852	7913.516	0.00	1040.0	252.661	8104.540	0.00
350.0	74.630	7916.463	0.00	1050.0	255.030	8107.088	0.00
360.0	77.404	7919.400	0.00	1060.0	257.394	8109.632	0.00
370.0	80.176	7922.328	0.00	1070.0	259.753	8112.171	0.00
380.0	82.943	7925.247	0.00	1080.0	262.105	8114.706	0.00
390.0	85.706	7928.157	0.00	1090.0	264.452	8117.236	0.00
400.0	88.464	7931.059	0.00	1100.0	266.793	8119.762	0.00
410.0	91.218	7933.953	0.00	1110.0	269.129	8122.283	0.00
420.0	93.967	7936.840	0.00	1120.0	271.459	8124.800	0.00
430.0	96.711	7939.719	0.00	1130.0	273.783	8127.312	0.00
440.0	99.450	7942.591	0.00	1140.0	276.102	8129.820	0.00
450.0	102.183	7945.455	0.00	1150.0	278.415	8132.324	0.00
460.0	104.910	7948.313	0.00	1160.0	280.723	8134.823	0.00
470.0	107.632	7951.164	0.00	1170.0	283.025	8137.318	0.00
480.0	110.348	7954.009	0.00	1180.0	285.321	8139.808	0.00
490.0	113.058	7956.847	0.00	1190.0	287.612	8142.294	0.00
500.0	115.763	7959.678	0.00	1200.0	289.898	8144.776	0.00
510.0	118.461	7962.503	0.00	1210.0	292.178	8147.253	0.00
520.0	121.153	7965.323	0.00	1220.0	294.452	8149.726	0.00
530.0	123.840	7968.136	0.00	1230.0	296.721	8152.195	0.00
540.0	126.520	7970.943	0.00	1240.0	298.985	8154.660	0.00
550.0	129.194	7973.744	0.00	1250.0	301.243	8157.120	0.00
560.0	131.862	7976.539	0.00	1260.0	303.496	8159.576	0.00
570.0	134.524	7979.328	0.00	1270.0	305.743	8162.027	0.00
580.0	137.179	7982.112	0.00	1280.0	307.986	8164.475	0.00
590.0	139.829	7984.890	0.00	1290.0	310.222	8166.918	0.00
600.0	142.472	7987.662	0.00	1300.0	312.454	8169.357	0.00
610.0	145.109	7990.428	0.00	1310.0	314.680	8171.792	0.00
620.0	147.739	7993.189	0.00	1320.0	316.901	8174.222	0.00
630.0	150.364	7995.945	0.00	1330.0	319.116	8176.649	0.00
640.0	152.982	7998.695	0.00	1340.0	321.327	8179.071	0.00
650.0	155.593	8001.440	0.00	1350.0	323.532	8181.489	0.00
660.0	158.199	8004.179	0.00	1360.0	325.731	8183.903	0.00
670.0	160.798	8006.913	0.00	1370.0	327.926	8186.313	0.00
680.0	163.391	8009.641	0.00	1380.0	330.115	8188.719	0.00
690.0	165.978	8012.365	0.00	1390.0	332.300	8191.120	0.00
700.0	168.559	8015.083	0.00	1400.0	334.479	8193.518	0.00
710.0	171.133	8017.795	0.00	1410.0	336.653	8195.911	0.00
720.0	173.701	8020.503	0.00	1420.0	338.821	8198.300	0.00
730.0	176.263	8023.205	0.00	1430.0	340.985	8200.686	0.00
740.0	178.818	8025.903	0.00	1440.0	343.144	8203.067	0.00
750.0	181.368	8028.595	0.00	1450.0	345.297	8205.444	0.00
760.0	183.911	8031.282	0.00	1460.0	347.445	8207.817	0.00
770.0	186.448	8033.964	0.00	1470.0	349.589	8210.186	0.00
780.0	188.979	8036.641	0.00	1480.0	351.727	8212.551	0.00
790.0	191.504	8039.313	0.00	1490.0	353.860	8214.912	0.00
800.0	194.022	8041.980	0.00	1500.0	355.989	8217.269	0.00



Таблица II

Угол входа — 0,4 град

Н, км	DVT, м/с	VBX, м/с	ТЕТА, ГРАД	Н, км	DVT, м/с	VBX, м/с	ТЕТА, ГРАД
110.0	64.288	7785.803	67.38	810.0	196.946	8044.271	0.00
120.0	36.886	7819.238	0.00	820.0	199.447	8046.933	0.00
130.0	29.674	7832.470	0.00	830.0	201.942	8049.591	0.00
140.0	27.648	7840.601	0.00	840.0	204.431	8052.243	0.00
150.0	27.459	7846.681	0.00	850.0	206.914	8054.890	0.00
160.0	28.386	7851.731	0.00	860.0	209.391	8057.532	0.00
170.0	29.892	7856.189	0.00	870.0	211.862	8060.169	0.00
180.0	31.756	7860.275	0.00	880.0	214.328	8062.802	0.00
190.0	33.857	7864.111	0.00	890.0	216.787	8065.429	0.00
200.0	36.122	7867.769	0.00	900.0	219.241	8068.051	0.00
210.0	38.503	7871.297	0.00	910.0	221.688	8070.669	0.00
220.0	40.970	7874.726	0.00	920.0	224.130	8073.282	0.00
230.0	43.500	7878.078	0.00	930.0	226.566	8075.890	0.00
240.0	46.080	7881.367	0.00	940.0	228.996	8078.493	0.00
250.0	48.697	7884.606	0.00	950.0	231.420	8081.091	0.00
260.0	51.344	7887.802	0.00	960.0	233.839	8083.684	0.00
270.0	54.012	7890.962	0.00	970.0	236.251	8086.273	0.00
280.0	56.699	7894.091	0.00	980.0	238.658	8088.857	0.00
290.0	59.399	7897.194	0.00	990.0	241.059	8091.436	0.00
300.0	62.109	7900.273	0.00	1000.0	243.455	8094.011	0.00
310.0	64.828	7903.331	0.00	1010.0	245.844	8096.581	0.00
320.0	67.552	7906.370	0.00	1020.0	248.228	8099.146	0.00
330.0	70.280	7909.393	0.00	1030.0	250.606	8101.706	0.00
340.0	73.011	7912.399	0.00	1040.0	252.978	8104.262	0.00
350.0	75.744	7915.391	0.00	1050.0	255.345	8106.814	0.00
360.0	78.476	7918.370	0.00	1060.0	257.706	8109.360	0.00
370.0	81.209	7921.336	0.00	1070.0	260.061	8111.902	0.00
380.0	83.940	7924.291	0.00	1080.0	262.411	8114.440	0.00
390.0	86.670	7927.234	0.00	1090.0	264.755	8116.973	0.00
400.0	89.398	7930.167	0.00	1100.0	267.094	8119.501	0.00
410.0	92.122	7933.091	0.00	1110.0	269.427	8122.025	0.00
420.0	94.844	7936.004	0.00	1120.0	271.754	8124.545	0.00
430.0	97.562	7938.909	0.00	1130.0	274.076	8127.060	0.00
440.0	100.277	7941.805	0.00	1140.0	276.392	8129.570	0.00
450.0	102.987	7944.692	0.00	1150.0	278.702	8132.076	0.00
460.0	105.693	7947.572	0.00	1160.0	281.008	8134.578	0.00
470.0	108.394	7950.443	0.00	1170.0	283.307	8137.075	0.00
480.0	111.091	7953.307	0.00	1180.0	285.601	8139.568	0.00
490.0	113.783	7956.163	0.00	1190.0	287.890	8142.056	0.00
500.0	116.470	7959.012	0.00	1200.0	290.173	8144.540	0.00
510.0	119.152	7961.854	0.00	1210.0	292.451	8147.020	0.00
520.0	121.829	7964.688	0.00	1220.0	294.723	8149.495	0.00
530.0	124.500	7967.516	0.00	1230.0	296.990	8151.966	0.00
540.0	127.166	7970.338	0.00	1240.0	299.252	8154.433	0.00
550.0	129.826	7973.152	0.00	1250.0	301.508	8156.895	0.00
560.0	132.481	7975.961	0.00	1260.0	303.759	8159.353	0.00
570.0	135.130	7978.762	0.00	1270.0	306.004	8161.806	0.00
580.0	137.774	7981.558	0.00	1280.0	308.244	8164.256	0.00
590.0	140.412	7984.347	0.00	1290.0	310.479	8166.701	0.00
600.0	143.044	7987.131	0.00	1300.0	312.709	8169.142	0.00
610.0	145.670	7989.908	0.00	1310.0	314.933	8171.579	0.00
620.0	148.290	7992.679	0.00	1320.0	317.152	8174.011	0.00
630.0	150.905	7995.445	0.00	1330.0	319.366	8176.439	0.00
640.0	153.514	7998.204	0.00	1340.0	321.574	8178.863	0.00
650.0	156.116	8000.958	0.00	1350.0	323.778	8181.283	0.00
660.0	158.713	8003.706	0.00	1360.0	325.976	8183.699	0.00
670.0	161.304	8006.448	0.00	1370.0	328.169	8186.110	0.00
680.0	163.889	8009.185	0.00	1380.0	330.356	8188.518	0.00
690.0	166.467	8011.916	0.00	1390.0	332.539	8190.921	0.00
700.0	169.040	8014.642	0.00	1400.0	334.716	8193.320	0.00
710.0	171.607	8017.362	0.00	1410.0	336.889	8195.715	0.00
720.0	174.168	8020.077	0.00	1420.0	339.056	8198.106	0.00
730.0	176.723	8022.786	0.00	1430.0	341.218	8200.492	0.00
740.0	179.272	8025.490	0.00	1440.0	343.375	8202.875	0.00
750.0	181.815	8028.189	0.00	1450.0	345.527	8205.254	0.00
760.0	184.352	8030.882	0.00	1460.0	347.674	8207.628	0.00
770.0	186.882	8033.570	0.00	1470.0	349.816	8209.999	0.00
780.0	189.407	8036.253	0.00	1480.0	351.952	8212.365	0.00
790.0	191.926	8038.931	0.00	1490.0	354.084	8214.728	0.00
800.0	194.439	8041.604	0.00	1500.0	356.211	8217.086	0.00

Угол входа — 0,5 град

H, мм	DVT, м/с	VBX, м/с	ТЕТА, ГРАД	H, мм	DVT, м/с	VBX, м/с	ТЕТА, ГРАД
110.0	98.127	7752.018	74.98	810.0	197.475	8043.794	0.00
120.0	54.079	7802.098	25.70	820.0	199.969	8046.463	0.00
130.0	41.207	7820.990	0.00	830.0	202.458	8049.127	0.00
140.0	36.230	7831.972	0.00	840.0	204.940	8051.785	0.00
150.0	34.423	7839.771	0.00	850.0	207.417	8054.439	0.00
160.0	34.202	7845.969	0.00	860.0	209.888	8057.088	0.00
170.0	34.885	7851.249	0.00	870.0	212.353	8059.731	0.00
180.0	36.133	7855.951	0.00	880.0	214.813	8062.369	0.00
190.0	37.754	7860.267	0.00	890.0	217.266	8065.002	0.00
200.0	39.634	7864.310	0.00	900.0	219.714	8067.630	0.00
210.0	41.700	7868.153	0.00	910.0	222.157	8070.253	0.00
220.0	43.905	7871.845	0.00	920.0	224.593	8072.871	0.00
230.0	46.213	7875.418	0.00	930.0	227.024	8075.484	0.00
240.0	48.603	7878.898	0.00	940.0	229.449	8078.092	0.00
250.0	51.055	7882.302	0.00	950.0	231.858	8080.695	0.00
260.0	53.556	7885.642	0.00	960.0	234.282	8083.293	0.00
270.0	56.097	7888.930	0.00	970.0	236.690	8085.886	0.00
280.0	58.670	7892.173	0.00	980.0	239.092	8088.475	0.00
290.0	61.269	7895.377	0.00	990.0	241.489	8091.059	0.00
300.0	63.888	7898.548	0.00	1000.0	243.880	8093.637	0.00
310.0	66.524	7901.689	0.00	1010.0	246.265	8096.212	0.00
320.0	69.173	7904.803	0.00	1020.0	248.645	8098.781	0.00
330.0	71.832	7907.894	0.00	1030.0	251.019	8101.346	0.00
340.0	74.500	7910.963	0.00	1040.0	253.387	8103.905	0.00
350.0	77.175	7914.013	0.00	1050.0	255.750	8106.461	0.00
360.0	79.854	7917.045	0.00	1060.0	258.107	8109.011	0.00
370.0	82.537	7920.061	0.00	1070.0	260.459	8111.557	0.00
380.0	85.223	7923.062	0.00	1080.0	262.805	8114.098	0.00
390.0	87.910	7926.048	0.00	1090.0	265.145	8116.635	0.00
400.0	90.597	7929.021	0.00	1100.0	267.480	8119.167	0.00
410.0	93.284	7931.982	0.00	1110.0	269.809	8121.694	0.00
420.0	95.971	7934.930	0.00	1120.0	272.133	8124.217	0.00
430.0	98.656	7937.868	0.00	1130.0	274.452	8126.735	0.00
440.0	101.340	7940.795	0.00	1140.0	276.765	8129.249	0.00
450.0	104.021	7943.711	0.00	1150.0	279.072	8131.758	0.00
460.0	106.699	7946.618	0.00	1160.0	281.374	8134.263	0.00
470.0	109.374	7949.516	0.00	1170.0	283.671	8136.763	0.00
480.0	112.046	7952.404	0.00	1180.0	285.962	8139.259	0.00
490.0	114.715	7955.284	0.00	1190.0	288.247	8141.750	0.00
500.0	117.380	7958.155	0.00	1200.0	290.528	8144.237	0.00
510.0	120.040	7961.018	0.00	1210.0	292.803	8146.720	0.00
520.0	122.697	7963.873	0.00	1220.0	295.072	8149.198	0.00
530.0	125.349	7966.721	0.00	1230.0	297.336	8151.671	0.00
540.0	127.995	7969.560	0.00	1240.0	299.595	8154.141	0.00
550.0	130.639	7972.392	0.00	1250.0	301.849	8156.606	0.00
560.0	133.277	7975.218	0.00	1260.0	304.097	8159.066	0.00
570.0	135.910	7978.035	0.00	1270.0	306.340	8161.522	0.00
580.0	138.538	7980.846	0.00	1280.0	308.577	8163.974	0.00
590.0	141.161	7983.651	0.00	1290.0	310.810	8166.422	0.00
600.0	143.779	7986.448	0.00	1300.0	313.037	8168.865	0.00
610.0	146.392	7989.239	0.00	1310.0	315.258	8171.304	0.00
620.0	148.999	7992.023	0.00	1320.0	317.475	8173.739	0.00
630.0	151.601	7994.801	0.00	1330.0	319.686	8176.170	0.00
640.0	154.197	7997.573	0.00	1340.0	321.893	8178.596	0.00
650.0	155.788	8000.338	0.00	1350.0	324.094	8181.018	0.00
660.0	159.374	8003.098	0.00	1360.0	326.290	8183.436	0.00
670.0	161.953	8005.851	0.00	1370.0	328.480	8185.850	0.00
680.0	164.528	8008.598	0.00	1380.0	330.666	8188.259	0.00
690.0	167.096	8011.340	0.00	1390.0	332.846	8190.664	0.00
700.0	169.659	8014.075	0.00	1400.0	335.022	8193.066	0.00
710.0	172.217	8016.805	0.00	1410.0	337.192	8195.463	0.00
720.0	174.768	8019.529	0.00	1420.0	339.357	8197.855	0.00
730.0	177.314	8022.247	0.00	1430.0	341.517	8200.244	0.00
740.0	179.855	8024.960	0.00	1440.0	343.672	8202.629	0.00
750.0	182.389	8027.667	0.00	1450.0	345.822	8205.009	0.00
760.0	184.918	8030.368	0.00	1460.0	347.967	8207.386	0.00
770.0	187.441	8033.064	0.00	1470.0	350.107	8209.758	0.00
780.0	189.958	8035.755	0.00	1480.0	352.242	8212.127	0.00
790.0	192.469	8038.440	0.00	1490.0	354.372	8214.491	0.00
800.0	194.975	8041.120	0.00	1500.0	356.497	8216.851	0.00

Угол входа — 0,6 град

Н, км	DVT, м/с	VBX, м/с	ТЕТА, ГРАД	Н, км	DVT, м/с	VBX, м/с	ТЕТА, ГРАД
110.0	38.892	7711.317	78.93	810.0	198.122	8043.212	0.00
120.0	74.941	7781.302	49.09	820.0	200.607	8045.889	0.00
130.0	55.235	7807.028	0.00	830.0	203.088	8048.561	0.00
140.0	46.802	7821.466	0.00	840.0	205.562	8051.228	0.00
150.0	42.909	7831.350	0.00	850.0	208.031	8053.889	0.00
160.0	41.293	7838.944	0.00	860.0	210.495	8056.544	0.00
170.0	40.977	7845.223	0.00	870.0	212.953	8059.195	0.00
180.0	41.474	7850.677	0.00	880.0	215.405	8061.840	0.00
190.0	42.509	7855.577	0.00	890.0	217.852	8064.480	0.00
200.0	43.921	7860.089	0.00	900.0	220.293	8067.115	0.00
210.0	45.603	7864.316	0.00	910.0	222.729	8069.744	0.00
220.0	47.488	7868.327	0.00	920.0	225.159	8072.368	0.00
230.0	49.525	7872.172	0.00	930.0	227.584	8074.988	0.00
240.0	51.682	7875.884	0.00	940.0	230.002	8077.602	0.00
250.0	53.933	7879.489	0.00	950.0	232.416	8080.211	0.00
260.0	56.258	7883.006	0.00	960.0	234.824	8082.815	0.00
270.0	58.644	7886.449	0.00	970.0	237.226	8085.414	0.00
280.0	61.078	7889.831	0.00	980.0	239.623	8088.008	0.00
290.0	63.553	7893.159	0.00	990.0	242.014	8090.597	0.00
300.0	66.060	7896.441	0.00	1000.0	244.399	8093.181	0.00
310.0	68.595	7899.682	0.00	1010.0	246.779	8095.761	0.00
320.0	71.152	7902.889	0.00	1020.0	249.154	8098.335	0.00
330.0	73.728	7906.033	0.00	1030.0	251.523	8100.905	0.00
340.0	76.319	7909.209	0.00	1040.0	253.885	8103.469	0.00
350.0	78.923	7912.330	0.00	1050.0	256.244	8106.029	0.00
360.0	81.537	7915.437	0.00	1060.0	258.597	8108.584	0.00
370.0	84.160	7918.504	0.00	1070.0	260.944	8111.135	0.00
380.0	86.789	7921.560	0.00	1080.0	263.285	8113.681	0.00
390.0	89.424	7924.599	0.00	1090.0	265.621	8116.222	0.00
400.0	92.062	7927.621	0.00	1100.0	267.952	8118.758	0.00
410.0	94.704	7930.627	0.00	1110.0	270.277	8121.289	0.00
420.0	97.348	7933.619	0.00	1120.0	272.597	8123.816	0.00
430.0	99.993	7936.595	0.00	1130.0	274.911	8126.339	0.00
440.0	102.638	7939.561	0.00	1140.0	277.220	8128.857	0.00
450.0	105.284	7942.513	0.00	1150.0	279.524	8131.370	0.00
460.0	107.928	7945.454	0.00	1160.0	281.822	8133.878	0.00
470.0	110.572	7948.383	0.00	1170.0	284.115	8136.382	0.00
480.0	113.214	7951.302	0.00	1180.0	286.402	8138.882	0.00
490.0	115.853	7954.210	0.00	1190.0	288.684	8141.377	0.00
500.0	118.491	7957.109	0.00	1200.0	290.961	8143.867	0.00
510.0	121.126	7959.998	0.00	1210.0	293.232	8146.353	0.00
520.0	123.757	7962.877	0.00	1220.0	295.498	8148.834	0.00
530.0	126.385	7965.748	0.00	1230.0	297.759	8151.311	0.00
540.0	129.011	7968.610	0.00	1240.0	300.015	8153.784	0.00
550.0	131.632	7971.464	0.00	1250.0	302.265	8156.252	0.00
560.0	134.250	7974.310	0.00	1260.0	304.510	8158.716	0.00
570.0	136.863	7977.147	0.00	1270.0	306.749	8161.175	0.00
580.0	139.472	7979.977	0.00	1280.0	308.984	8163.630	0.00
590.0	142.077	7982.799	0.00	1290.0	311.213	8166.081	0.00
600.0	144.678	7985.614	0.00	1300.0	313.437	8168.527	0.00
610.0	147.273	7988.422	0.00	1310.0	315.656	8170.969	0.00
620.0	149.865	7991.222	0.00	1320.0	317.870	8173.407	0.00
630.0	152.451	7994.015	0.00	1330.0	320.078	8175.840	0.00
640.0	155.033	7996.802	0.00	1340.0	322.282	8178.269	0.00
650.0	157.609	7999.582	0.00	1350.0	324.480	8180.694	0.00
660.0	160.181	8002.355	0.00	1360.0	326.673	8183.115	0.00
670.0	162.747	8005.121	0.00	1370.0	328.861	8185.531	0.00
680.0	165.309	8007.882	0.00	1380.0	331.044	8187.943	0.00
690.0	167.865	8010.635	0.00	1390.0	333.222	8190.351	0.00
700.0	170.416	8013.383	0.00	1400.0	335.395	8192.755	0.00
710.0	172.962	8016.124	0.00	1410.0	337.562	8195.154	0.00
720.0	175.502	8018.859	0.00	1420.0	339.725	8197.550	0.00
730.0	178.037	8021.589	0.00	1430.0	341.883	8199.941	0.00
740.0	180.567	8024.312	0.00	1440.0	344.035	8202.328	0.00
750.0	183.091	8027.029	0.00	1450.0	346.183	8204.711	0.00
760.0	185.610	8029.740	0.00	1460.0	348.326	8207.090	0.00
770.0	188.123	8032.446	0.00	1470.0	350.463	8209.464	0.00
780.0	190.631	8035.146	0.00	1480.0	352.596	8211.835	0.00
790.0	193.133	8037.840	0.00	1490.0	354.724	8214.201	0.00
800.0	195.630	8040.529	0.00	1500.0	356.847	8216.564	0.00

Угол входа — 0,7 град

Н, км	DVT, м/с	VBX, м/с	ТЕТА, ГРАД	Н, км	DVT, м/с	VBX, м/с	ТЕТА, ГРАД
110.0	185.251	7664.034	81.16	110.0	198.885	8042.523	0.00
120.0	99.381	7756.938	60.05	120.0	201.361	8045.211	0.00
130.0	71.716	7790.623	0.00	130.0	203.832	8047.892	0.00
140.0	59.241	7809.103	0.00	140.0	206.297	8050.568	0.00
150.0	52.903	7821.433	0.00	150.0	208.757	8053.238	0.00
160.0	49.648	7830.666	0.00	160.0	211.212	8055.903	0.00
170.0	48.158	7838.120	0.00	170.0	213.661	8058.562	0.00
180.0	47.771	7844.457	0.00	180.0	216.105	8061.215	0.00
190.0	48.118	7850.046	0.00	190.0	218.544	8063.863	0.00
200.0	48.978	7855.109	0.00	200.0	220.977	8066.506	0.00
210.0	50.208	7859.788	0.00	210.0	223.405	8069.143	0.00
220.0	51.716	7854.176	0.00	220.0	225.828	8071.775	0.00
230.0	53.434	7868.340	0.00	230.0	228.245	8074.402	0.00
240.0	55.317	7872.326	0.00	240.0	230.656	8077.023	0.00
250.0	57.330	7876.169	0.00	250.0	233.063	8079.639	0.00
260.0	59.447	7879.893	0.00	260.0	235.464	8082.250	0.00
270.0	61.649	7883.521	0.00	270.0	237.859	8084.856	0.00
280.0	63.921	7887.065	0.00	280.0	240.249	8087.456	0.00
290.0	66.249	7890.539	0.00	290.0	242.634	8090.052	0.00
300.0	68.625	7893.953	0.00	300.0	245.013	8092.642	0.00
310.0	71.041	7897.313	0.00	310.0	247.387	8095.228	0.00
320.0	73.490	7900.628	0.00	320.0	249.756	8097.808	0.00
330.0	75.967	7903.901	0.00	330.0	252.119	8100.384	0.00
340.0	78.467	7907.138	0.00	340.0	254.476	8102.954	0.00
350.0	80.987	7910.342	0.00	350.0	256.829	8105.520	0.00
360.0	83.525	7913.517	0.00	360.0	259.176	8108.080	0.00
370.0	86.076	7916.664	0.00	370.0	261.517	8110.636	0.00
380.0	88.639	7919.787	0.00	380.0	263.853	8113.187	0.00
390.0	91.212	7922.887	0.00	390.0	266.184	8115.733	0.00
400.0	93.793	7925.967	0.00	400.0	268.510	8118.275	0.00
410.0	96.381	7929.027	0.00	410.0	270.830	8120.811	0.00
420.0	98.974	7932.069	0.00	420.0	273.145	8123.343	0.00
430.0	101.571	7935.094	0.00	430.0	275.454	8125.870	0.00
440.0	104.172	7938.104	0.00	440.0	277.759	8128.393	0.00
450.0	106.775	7941.098	0.00	450.0	280.057	8130.910	0.00
460.0	109.380	7944.078	0.00	460.0	282.351	8133.423	0.00
470.0	111.986	7947.045	0.00	470.0	284.639	8135.932	0.00
480.0	114.592	7950.000	0.00	480.0	286.922	8138.436	0.00
490.0	117.198	7952.942	0.00	490.0	289.200	8140.935	0.00
500.0	119.803	7955.873	0.00	500.0	291.473	8143.430	0.00
510.0	122.408	7958.792	0.00	510.0	293.740	8145.920	0.00
520.0	125.010	7961.701	0.00	520.0	296.002	8148.405	0.00
530.0	127.611	7964.599	0.00	530.0	298.259	8150.885	0.00
540.0	130.209	7967.488	0.00	540.0	300.510	8153.363	0.00
550.0	132.805	7970.367	0.00	550.0	302.757	8155.835	0.00
560.0	135.398	7973.237	0.00	560.0	304.998	8158.302	0.00
570.0	137.989	7976.098	0.00	570.0	307.234	8160.765	0.00
580.0	140.576	7978.950	0.00	580.0	309.465	8163.224	0.00
590.0	143.159	7981.793	0.00	590.0	311.690	8165.678	0.00
600.0	145.739	7984.629	0.00	600.0	313.911	8168.128	0.00
610.0	148.315	7987.456	0.00	610.0	316.126	8170.573	0.00
620.0	150.887	7990.275	0.00	620.0	318.336	8173.014	0.00
630.0	153.456	7993.087	0.00	630.0	320.541	8175.451	0.00
640.0	156.020	7995.891	0.00	640.0	322.742	8177.883	0.00
650.0	158.579	7998.688	0.00	650.0	324.937	8180.312	0.00
660.0	161.135	8001.477	0.00	660.0	327.126	8182.735	0.00
670.0	163.685	8004.259	0.00	670.0	329.311	8185.155	0.00
680.0	166.231	8007.035	0.00	680.0	331.491	8187.570	0.00
690.0	168.773	8009.803	0.00	690.0	333.665	8189.981	0.00
700.0	171.310	8012.565	0.00	700.0	335.836	8192.388	0.00
710.0	173.842	8015.320	0.00	710.0	338.000	8194.790	0.00
720.0	176.369	8018.068	0.00	720.0	340.160	8197.188	0.00
730.0	178.891	8020.810	0.00	730.0	342.315	8199.582	0.00
740.0	181.408	8023.546	0.00	740.0	344.465	8201.972	0.00
750.0	183.920	8026.275	0.00	750.0	346.609	8204.358	0.00
760.0	186.427	8028.998	0.00	760.0	348.749	8206.739	0.00
770.0	188.929	8031.715	0.00	770.0	350.884	8209.117	0.00
780.0	191.426	8034.426	0.00	780.0	353.014	8211.490	0.00
790.0	193.918	8037.131	0.00	790.0	355.139	8213.859	0.00
800.0	196.404	8039.830	0.00	800.0	357.260	8216.224	0.00



## Угол входа — 0,8 град

Н, км	DVT, м/с	VВХ, м/с	ТЕТА, ГРАД	Н, км	DVT, м/с	VВХ, м/с	ТЕТА, ГРАД
110.0	239.828	7610.544	82.44	810.0	199.766	8041.729 <sup>9</sup>	0.00
120.0	127.298	7729.110	66.65	820.0	202.231	8044.428 <sup>8</sup>	0.00
130.0	90.604	7771.824	35.75	830.0	204.691	8047.120	0.00
140.0	73.521	7794.912	0.00	840.0	207.145	8049.807	0.00
150.0	64.388	7810.037	0.00	850.0	209.595	8052.488	0.00
160.0	59.256	7821.147	0.00	860.0	212.039	8055.162	0.00
170.0	56.419	7829.948	0.00	870.0	214.479	8057.831	0.00
180.0	55.018	7837.298	0.00	880.0	216.913	8060.494	0.00
190.0	54.575	7843.678	0.00	890.0	219.342	8063.152	0.00
200.0	54.801	7849.375	0.00	900.0	221.765	8065.804	0.00
210.0	55.512	7854.573	0.00	910.0	224.185	8068.450	0.00
220.0	56.586	7859.395	0.00	920.0	226.599	8071.090	0.00
230.0	57.937	7863.926	0.00	930.0	229.007	8073.725	0.00
240.0	59.505	7868.227	0.00	940.0	231.411	8076.355	0.00
250.0	61.245	7872.343	0.00	950.0	233.809	8078.979	0.00
260.0	63.123	7876.307	0.00	960.0	236.202	8081.598	0.00
270.0	65.114	7880.145	0.00	970.0	238.590	8084.212	0.00
280.0	67.197	7883.878	0.00	980.0	240.972	8086.820	0.00
290.0	69.357	7887.520	0.00	990.0	243.349	8089.423	0.00
300.0	71.582	7891.085	0.00	1000.0	245.721	8092.021	0.00
310.0	73.860	7894.583	0.00	1010.0	248.088	8094.613	0.00
320.0	76.184	7898.022	0.00	1020.0	250.450	8097.200	0.00
330.0	78.547	7901.409	0.00	1030.0	252.806	8099.783	0.00
340.0	80.944	7904.750	0.00	1040.0	255.157	8102.360	0.00
350.0	83.368	7908.051	0.00	1050.0	257.503	8104.932	0.00
360.0	85.816	7911.314	0.00	1060.0	259.843	8107.499	0.00
370.0	88.285	7914.543	0.00	1070.0	262.179	8110.061	0.00
380.0	90.772	7917.743	0.00	1080.0	264.509	8112.618	0.00
390.0	93.274	7920.914	0.00	1090.0	266.834	8115.170	0.00
400.0	95.788	7924.060	0.00	1100.0	269.153	8117.717	0.00
410.0	98.314	7927.182	0.00	1110.0	271.468	8120.260	0.00
420.0	100.849	7930.282	0.00	1120.0	273.777	8122.797	0.00
430.0	103.392	7933.362	0.00	1130.0	276.081	8125.330	0.00
440.0	105.941	7936.423	0.00	1140.0	278.380	8127.858	0.00
450.0	108.496	7939.466	0.00	1150.0	280.673	8130.381	0.00
460.0	111.055	7942.492	0.00	1160.0	282.961	8132.899	0.00
470.0	113.617	7945.503	0.00	1170.0	285.245	8135.412	0.00
480.0	116.182	7948.498	0.00	1180.0	287.523	8137.921	0.00
490.0	118.749	7951.479	0.00	1190.0	289.795	8140.425	0.00
500.0	121.317	7954.447	0.00	1200.0	292.063	8142.925	0.00
510.0	123.886	7957.402	0.00	1210.0	294.325	8145.420	0.00
520.0	126.455	7960.344	0.00	1220.0	296.583	8147.910	0.00
530.0	129.024	7963.275	0.00	1230.0	298.835	8150.395	0.00
540.0	131.591	7966.194	0.00	1240.0	301.082	8152.876	0.00
550.0	134.158	7969.102	0.00	1250.0	303.324	8155.353	0.00
560.0	136.723	7972.000	0.00	1260.0	305.561	8157.825	0.00
570.0	139.287	7974.887	0.00	1270.0	307.792	8160.292	0.00
580.0	141.848	7977.765	0.00	1280.0	310.019	8162.755	0.00
590.0	144.407	7980.633	0.00	1290.0	312.240	8165.213	0.00
600.0	146.963	7983.492	0.00	1300.0	314.457	8167.667	0.00
610.0	149.517	7986.342	0.00	1310.0	316.668	8170.117	0.00
620.0	152.067	7989.183	0.00	1320.0	318.875	8172.562	0.00
630.0	154.614	7992.016	0.00	1330.0	321.076	8175.002	0.00
640.0	157.158	7994.840	0.00	1340.0	323.272	8177.438	0.00
650.0	159.698	7997.656	0.00	1350.0	325.463	8179.870	0.00
660.0	162.235	8000.465	0.00	1360.0	327.649	8182.298	0.00
670.0	164.767	8003.265	0.00	1370.0	329.831	8184.721	0.00
680.0	167.296	8006.058	0.00	1380.0	332.007	8187.139	0.00
690.0	169.820	8008.843	0.00	1390.0	334.178	8189.554	0.00
700.0	172.341	8011.621	0.00	1400.0	336.344	8191.964	0.00
710.0	174.857	8014.392	0.00	1410.0	338.506	8194.370	0.00
720.0	177.369	8017.156	0.00	1420.0	340.662	8196.771	0.00
730.0	179.876	8019.913	0.00	1430.0	342.813	8199.169	0.00
740.0	182.379	8022.663	0.00	1440.0	344.960	8201.562	0.00
750.0	184.877	8025.406	0.00	1450.0	347.101	8203.951	0.00
760.0	187.370	8028.143	0.00	1460.0	349.238	8206.336	0.00
770.0	189.859	8030.873	0.00	1470.0	351.370	8208.716	0.00
780.0	192.343	8033.596	0.00	1480.0	353.497	8211.092	0.00
790.0	194.823	8036.314	0.00	1490.0	355.619	8213.465	0.00
800.0	197.297	8039.025	0.00	1500.0	357.736	8215.833	0.00

Угол входа — 0,9 град

Н, мм	DVT, м/с	VBX, м/с	ТЕТА, ГРАД	Н, мм	DVT, м/с	VBX, м/с	ТЕТА, ГРАД
110,0	209,213	7551,257	83,16	810,0	200,765	8040,830	0,00
120,0	158,577	7697,930	71,02	820,0	203,216	8043,541	0,00
130,0	111,846	7750,682	48,52	830,0	205,664	8046,246	0,00
140,0	89,611	7778,923	0,00	840,0	208,105	8048,945	0,00
150,0	77,343	7797,183	0,00	850,0	210,544	8051,637	0,00
160,0	70,102	7810,401	0,00	860,0	212,977	8054,324	0,00
170,0	65,750	7820,717	0,00	870,0	215,405	8057,004	0,00
180,0	63,208	7829,210	0,00	880,0	217,828	8059,678	0,00
190,0	61,873	7836,480	0,00	890,0	220,247	8062,346	0,00
200,0	61,385	7842,892	0,00	900,0	222,660	8065,008	0,00
210,0	61,510	7848,676	0,00	910,0	225,069	8067,664	0,00
220,0	62,095	7853,987	0,00	920,0	227,473	8070,315	0,00
230,0	63,032	7858,932	0,00	930,0	229,872	8072,960	0,00
240,0	64,244	7863,589	0,00	940,0	232,266	8075,599	0,00
250,0	65,675	7868,014	0,00	950,0	234,654	8078,232	0,00
260,0	67,282	7872,248	0,00	960,0	237,038	8080,860	0,00
270,0	69,034	7876,325	0,00	970,0	239,417	8083,482	0,00
280,0	70,905	7880,270	0,00	980,0	241,791	8086,099	0,00
290,0	72,875	7884,102	0,00	990,0	244,160	8088,710	0,00
300,0	74,929	7887,839	0,00	1000,0	246,524	8091,316	0,00
310,0	77,052	7891,491	0,00	1010,0	248,882	8093,917	0,00
320,0	79,235	7895,071	0,00	1020,0	251,236	8096,512	0,00
330,0	81,469	7898,588	0,00	1030,0	253,585	8099,102	0,00
340,0	83,747	7902,047	0,00	1040,0	255,928	8101,686	0,00
350,0	86,063	7905,456	0,00	1050,0	258,267	8104,266	0,00
360,0	88,411	7908,819	0,00	1060,0	260,600	8106,840	0,00
370,0	90,787	7912,142	0,00	1070,0	262,928	8109,409	0,00
380,0	93,187	7915,428	0,00	1080,0	265,251	8111,973	0,00
390,0	95,609	7918,679	0,00	1090,0	267,569	8114,532	0,00
400,0	98,048	7921,900	0,00	1100,0	269,882	8117,085	0,00
410,0	100,504	7925,093	0,00	1110,0	272,190	8119,635	0,00
420,0	102,973	7928,259	0,00	1120,0	274,493	8122,178	0,00
430,0	105,453	7931,401	0,00	1130,0	276,791	8124,717	0,00
440,0	107,944	7934,520	0,00	1140,0	279,083	8127,251	0,00
450,0	110,444	7937,618	0,00	1150,0	281,371	8129,780	0,00
460,0	112,951	7940,696	0,00	1160,0	283,653	8132,305	0,00
470,0	115,464	7943,755	0,00	1170,0	285,930	8134,824	0,00
480,0	117,983	7946,797	0,00	1180,0	288,203	8137,338	0,00
490,0	120,506	7949,823	0,00	1190,0	290,470	8139,848	0,00
500,0	123,032	7952,832	0,00	1200,0	292,732	8142,353	0,00
510,0	125,561	7955,827	0,00	1210,0	294,989	8144,853	0,00
520,0	128,092	7958,807	0,00	1220,0	297,241	8147,349	0,00
530,0	130,624	7961,774	0,00	1230,0	299,488	8149,839	0,00
540,0	133,157	7964,728	0,00	1240,0	301,730	8152,325	0,00
550,0	135,691	7967,669	0,00	1250,0	303,967	8154,807	0,00
560,0	138,224	7970,599	0,00	1260,0	306,199	8157,281	0,00
570,0	140,757	7973,516	0,00	1270,0	308,425	8159,756	0,00
580,0	143,290	7976,423	0,00	1280,0	310,647	8162,223	0,00
590,0	145,821	7979,319	0,00	1290,0	312,864	8164,687	0,00
600,0	148,350	7982,205	0,00	1300,0	315,076	8167,145	0,00
610,0	150,878	7985,081	0,00	1310,0	317,283	8169,599	0,00
620,0	153,403	7987,946	0,00	1320,0	319,484	8172,048	0,00
630,0	155,927	7990,803	0,00	1330,0	321,681	8174,493	0,00
640,0	158,448	7993,650	0,00	1340,0	323,873	8176,934	0,00
650,0	160,966	7996,488	0,00	1350,0	326,060	8179,370	0,00
660,0	163,481	7999,318	0,00	1360,0	328,242	8181,802	0,00
670,0	165,993	8002,139	0,00	1370,0	330,419	8184,229	0,00
680,0	168,502	8004,951	0,00	1380,0	332,591	8186,652	0,00
690,0	171,007	8007,756	0,00	1390,0	334,758	8189,070	0,00
700,0	173,509	8010,552	0,00	1400,0	336,921	8191,484	0,00
710,0	176,007	8013,341	0,00	1410,0	339,078	8193,894	0,00
720,0	178,501	8016,122	0,00	1420,0	341,231	8196,299	0,00
730,0	180,992	8018,896	0,00	1430,0	343,378	8198,700	0,00
740,0	183,478	8021,662	0,00	1440,0	345,521	8201,097	0,00
750,0	185,961	8024,421	0,00	1450,0	347,659	8203,490	0,00
760,0	188,439	8027,173	0,00	1460,0	349,792	8205,878	0,00
770,0	190,913	8029,918	0,00	1470,0	351,920	8208,262	0,00
780,0	193,382	8032,656	0,00	1480,0	354,044	8210,642	0,00
790,0	195,848	8035,387	0,00	1490,0	356,162	8213,017	0,00
800,0	198,308	8038,112	0,00	1500,0	358,276	8215,389	0,00

## Угол входа — 1,0 град

Н, км	DVT, м/с	VВХ, м/с	ТЕТА, ГРАД	Н, км	DVT, м/с	VВХ, м/с	ТЕТА, ГРАД
110,0	363,969	7486,610	83,52	810,0	201,880	8039,825	0,00
120,0	193,092	7663,527	74,03	820,0	204,317	8042,550	0,00
130,0	135,383	7727,256	55,45	830,0	206,750	8045,269	0,00
140,0	107,478	7761,168	24,19	840,0	209,179	8047,982	0,00
150,0	91,746	7782,891	0,00	850,0	211,604	8050,687	0,00
160,0	82,172	7798,444	0,00	860,0	214,024	8053,386	0,00
170,0	76,140	7810,440	0,00	870,0	216,439	8056,079	0,00
180,0	72,331	7820,199	0,00	880,0	218,851	8058,765	0,00
190,0	70,007	7828,459	0,00	890,0	221,257	8061,445	0,00
200,0	68,724	7835,665	0,00	900,0	223,659	8064,119	0,00
210,0	68,198	7842,101	0,00	910,0	226,056	8066,787	0,00
220,0	68,238	7847,956	0,00	920,0	228,449	8069,448	0,00
230,0	68,714	7853,363	0,00	930,0	230,837	8072,104	0,00
240,0	69,530	7858,416	0,00	940,0	233,221	8074,753	0,00
250,0	70,617	7863,184	0,00	950,0	235,599	8077,397	0,00
260,0	71,924	7867,719	0,00	960,0	237,973	8080,035	0,00
270,0	73,410	7872,052	0,00	970,0	240,342	8082,667	0,00
280,0	75,044	7876,244	0,00	980,0	242,706	8085,293	0,00
290,0	76,802	7880,288	0,00	990,0	245,066	8087,914	0,00
300,0	78,664	7884,215	0,00	1000,0	247,420	8090,529	0,00
310,0	80,615	7888,041	0,00	1010,0	249,770	8093,138	0,00
320,0	82,641	7891,778	0,00	1020,0	252,115	8095,742	0,00
330,0	84,731	7895,438	0,00	1030,0	254,455	8098,341	0,00
340,0	86,878	7899,029	0,00	1040,0	256,790	8100,934	0,00
350,0	89,072	7902,559	0,00	1050,0	259,120	8103,522	0,00
360,0	91,308	7906,034	0,00	1060,0	261,445	8106,104	0,00
370,0	93,580	7909,461	0,00	1070,0	263,766	8108,681	0,00
380,0	95,884	7912,843	0,00	1080,0	266,081	8111,253	0,00
390,0	98,216	7916,184	0,00	1090,0	268,391	8113,819	0,00
400,0	100,572	7919,489	0,00	1100,0	270,697	8116,380	0,00
410,0	102,949	7922,760	0,00	1110,0	272,998	8118,936	0,00
420,0	105,344	7925,999	0,00	1120,0	275,293	8121,487	0,00
430,0	107,756	7929,210	0,00	1130,0	277,584	8124,033	0,00
440,0	110,182	7932,394	0,00	1140,0	279,869	8126,574	0,00
450,0	112,620	7935,554	0,00	1150,0	282,150	8129,110	0,00
460,0	115,069	7938,690	0,00	1160,0	284,426	8131,640	0,00
470,0	117,528	7941,804	0,00	1170,0	286,697	8134,166	0,00
480,0	119,994	7944,898	0,00	1180,0	288,963	8136,687	0,00
490,0	122,468	7947,972	0,00	1190,0	291,224	8139,203	0,00
500,0	124,947	7951,029	0,00	1200,0	293,480	8141,714	0,00
510,0	127,431	7954,058	0,00	1210,0	295,731	8144,220	0,00
520,0	129,920	7957,091	0,00	1220,0	297,977	8146,722	0,00
530,0	132,411	7960,098	0,00	1230,0	300,218	8149,218	0,00
540,0	134,903	7963,091	0,00	1240,0	302,454	8151,710	0,00
550,0	137,403	7966,069	0,00	1250,0	304,685	8154,197	0,00
560,0	139,901	7969,033	0,00	1260,0	306,911	8156,679	0,00
570,0	142,400	7971,985	0,00	1270,0	309,133	8159,157	0,00
580,0	144,900	7974,924	0,00	1280,0	311,349	8161,630	0,00
590,0	147,400	7977,851	0,00	1290,0	313,561	8164,098	0,00
600,0	149,899	7980,767	0,00	1300,0	315,767	8166,562	0,00
610,0	152,398	7983,671	0,00	1310,0	317,969	8169,021	0,00
620,0	154,896	7986,565	0,00	1320,0	320,166	8171,476	0,00
630,0	157,393	7989,448	0,00	1330,0	322,358	8173,925	0,00
640,0	159,888	7992,320	0,00	1340,0	324,545	8176,370	0,00
650,0	162,382	7995,183	0,00	1350,0	326,727	8178,811	0,00
660,0	164,873	7998,036	0,00	1360,0	328,904	8181,247	0,00
670,0	167,362	8000,880	0,00	1370,0	331,077	8183,679	0,00
680,0	169,849	8003,715	0,00	1380,0	333,244	8186,106	0,00
690,0	172,333	8006,541	0,00	1390,0	335,407	8188,529	0,00
700,0	174,814	8009,358	0,00	1400,0	337,565	8190,948	0,00
710,0	177,292	8012,167	0,00	1410,0	339,718	8193,362	0,00
720,0	179,767	8014,968	0,00	1420,0	341,866	8195,771	0,00
730,0	182,238	8017,760	0,00	1430,0	344,009	8198,177	0,00
740,0	184,707	8020,544	0,00	1440,0	346,148	8200,578	0,00
750,0	187,171	8023,321	0,00	1450,0	348,282	8202,974	0,00
760,0	189,633	8026,090	0,00	1460,0	350,411	8205,366	0,00
770,0	192,090	8028,851	0,00	1470,0	352,535	8207,754	0,00
780,0	194,543	8031,605	0,00	1480,0	354,655	8210,138	0,00
790,0	196,993	8034,352	0,00	1490,0	356,769	8212,517	0,00
800,0	199,439	8037,092	0,00	1500,0	358,879	8214,893	0,00

## Угол входа — 1.1 град

Н, км	DVT, м/с	VВХ, м/с	ТЕТА, ГРАД	Н, км	DVT, м/с	VВХ, м/с	ТЕТА, ГРАД
110.0	433.641	7417.057	83.62	810.0	203.112	8038.714	0.00
120.0	230.705	7626.035	76.17	820.0	205.534	8041.455	0.00
130.0	161.151	7701.612	61.94	830.0	207.951	8044.190	0.00
140.0	127.083	7741.687	39.09	840.0	210.365	8046.918	0.00
150.0	107.574	7767.187	0.00	850.0	212.775	8049.638	0.00
160.0	95.448	7785.292	0.00	860.0	215.181	8052.351	0.00
170.0	87.576	7799.128	0.00	870.0	217.582	8055.058	0.00
180.0	82.377	7810.277	0.00	880.0	219.980	8057.757	0.00
190.0	78.968	7819.623	0.00	890.0	222.373	8060.450	0.00
200.0	76.812	7827.701	0.00	900.0	224.763	8063.137	0.00
210.0	75.570	7834.853	0.00	910.0	227.147	8065.817	0.00
220.0	75.012	7841.306	0.00	920.0	229.528	8068.491	0.00
230.0	74.980	7847.221	0.00	930.0	231.904	8071.158	0.00
240.0	75.360	7852.710	0.00	940.0	234.276	8073.819	0.00
250.0	76.069	7857.856	0.00	950.0	236.643	8076.474	0.00
260.0	77.044	7862.723	0.00	960.0	239.006	8079.123	0.00
270.0	78.237	7867.359	0.00	970.0	241.364	8081.766	0.00
280.0	79.611	7871.801	0.00	980.0	243.717	8084.403	0.00
290.0	81.135	7876.079	0.00	990.0	246.067	8087.034	0.00
300.0	82.787	7880.217	0.00	1000.0	248.411	8089.659	0.00
310.0	84.547	7884.233	0.00	1010.0	250.751	8092.279	0.00
320.0	86.400	7888.143	0.00	1020.0	253.086	8094.892	0.00
330.0	88.332	7891.961	0.00	1030.0	255.416	8097.500	0.00
340.0	90.333	7895.697	0.00	1040.0	257.742	8100.103	0.00
350.0	92.394	7899.361	0.00	1050.0	260.063	8102.699	0.00
360.0	94.505	7902.960	0.00	1060.0	262.379	8105.290	0.00
370.0	96.664	7906.501	0.00	1070.0	264.691	8107.876	0.00
380.0	98.852	7909.989	0.00	1080.0	266.998	8110.456	0.00
390.0	101.095	7913.429	0.00	1090.0	269.300	8113.031	0.00
400.0	103.358	7916.826	0.00	1100.0	271.597	8115.601	0.00
410.0	105.649	7920.184	0.00	1110.0	273.890	8118.165	0.00
420.0	107.963	7923.504	0.00	1120.0	276.177	8120.723	0.00
430.0	110.298	7926.791	0.00	1130.0	278.460	8123.277	0.00
440.0	112.653	7930.047	0.00	1140.0	280.738	8125.825	0.00
450.0	115.023	7933.274	0.00	1150.0	283.012	8128.369	0.00
460.0	117.408	7936.474	0.00	1160.0	285.280	8130.907	0.00
470.0	119.806	7939.649	0.00	1170.0	287.544	8133.440	0.00
480.0	122.215	7942.800	0.00	1180.0	289.802	8135.967	0.00
490.0	124.634	7945.929	0.00	1190.0	292.056	8138.490	0.00
500.0	127.062	7949.037	0.00	1200.0	294.306	8141.008	0.00
510.0	129.497	7952.125	0.00	1210.0	296.550	8143.521	0.00
520.0	131.939	7955.195	0.00	1220.0	298.789	8146.029	0.00
530.0	134.386	7958.247	0.00	1230.0	301.024	8148.532	0.00
540.0	136.838	7961.282	0.00	1240.0	303.254	8151.030	0.00
550.0	139.294	7964.301	0.00	1250.0	305.479	8153.523	0.00
560.0	141.753	7967.305	0.00	1260.0	307.699	8156.011	0.00
570.0	144.215	7970.294	0.00	1270.0	309.914	8158.495	0.00
580.0	146.679	7973.269	0.00	1280.0	312.125	8160.974	0.00
590.0	149.144	7976.230	0.00	1290.0	314.331	8163.448	0.00
600.0	151.611	7979.178	0.00	1300.0	316.531	8165.917	0.00
610.0	154.078	7982.114	0.00	1310.0	318.727	8168.382	0.00
620.0	156.545	7985.038	0.00	1320.0	320.919	8170.842	0.00
630.0	159.013	7987.951	0.00	1330.0	323.105	8173.297	0.00
640.0	161.480	7990.852	0.00	1340.0	325.287	8175.747	0.00
650.0	163.946	7993.742	0.00	1350.0	327.464	8178.193	0.00
660.0	166.411	7996.621	0.00	1360.0	329.636	8180.635	0.00
670.0	168.875	7999.490	0.00	1370.0	331.803	8183.072	0.00
680.0	171.337	8002.350	0.00	1380.0	333.966	8185.504	0.00
690.0	173.797	8005.199	0.00	1390.0	336.123	8187.932	0.00
700.0	176.255	8008.039	0.00	1400.0	338.276	8190.355	0.00
710.0	178.711	8010.870	0.00	1410.0	340.425	8192.774	0.00
720.0	181.165	8013.692	0.00	1420.0	342.568	8195.188	0.00
730.0	183.616	8016.505	0.00	1430.0	344.707	8197.598	0.00
740.0	186.064	8019.309	0.00	1440.0	346.841	8200.003	0.00
750.0	188.509	8022.105	0.00	1450.0	348.970	8202.405	0.00
760.0	190.951	8024.893	0.00	1460.0	351.095	8204.801	0.00
770.0	193.390	8027.673	0.00	1470.0	353.215	8207.194	0.00
780.0	195.826	8030.445	0.00	1480.0	355.330	8209.582	0.00
790.0	198.258	8033.209	0.00	1490.0	357.440	8211.965	0.00
800.0	200.687	8035.965	0.00	1500.0	359.546	8214.344	0.00



## Угол входа — 1,2 град

Н, км	DVT, м/с	VВХ, м/с	ТЕТА, ГРАД	Н, км	DVT, м/с	VВХ, м/с	ТЕТА, ГРАД
110.0	507,763	7343,064	83,54	810.0	204,461	8037,499	0,00
120.0	271,274	7585,599	77,71	820.0	206,865	8040,258	0,00
130.0	189,090	7673,817	65,95	830.0	209,266	8043,009	0,00
140.0	148,387	7720,518	47,95	840.0	211,663	8045,753	0,00
150.0	124,800	7750,097	10,76	850.0	214,057	8048,489	0,00
160.0	109,911	7770,964	0,00	860.0	216,447	8051,218	0,00
170.0	100,044	7785,796	0,00	870.0	218,834	8053,939	0,00
180.0	93,337	7799,453	0,00	880.0	221,217	8056,654	0,00
190.0	88,747	7809,980	0,00	890.0	223,596	8059,361	0,00
200.0	85,642	7819,007	0,00	900.0	225,971	8062,062	0,00
210.0	83,621	7826,938	0,00	910.0	228,342	8064,756	0,00
220.0	82,411	7834,014	0,00	920.0	230,709	8067,443	0,00
230.0	81,826	7840,511	0,00	930.0	233,072	8070,123	0,00
240.0	81,731	7846,475	0,00	940.0	235,431	8072,797	0,00
250.0	82,027	7852,034	0,00	950.0	237,785	8075,464	0,00
260.0	82,611	7857,263	0,00	960.0	240,136	8078,125	0,00
270.0	83,514	7862,218	0,00	970.0	242,483	8080,780	0,00
280.0	84,603	7866,945	0,00	980.0	244,825	8083,429	0,00
290.0	85,873	7871,477	0,00	990.0	247,162	8086,071	0,00
300.0	87,295	7875,844	0,00	1000.0	249,496	8088,707	0,00
310.0	88,848	7880,068	0,00	1010.0	251,824	8091,337	0,00
320.0	90,511	7884,168	0,00	1020.0	254,149	8093,962	0,00
330.0	92,271	7888,159	0,00	1030.0	256,469	8096,580	0,00
340.0	94,113	7892,053	0,00	1040.0	258,785	8099,192	0,00
350.0	96,027	7895,853	0,00	1050.0	261,093	8101,799	0,00
360.0	98,005	7899,597	0,00	1060.0	263,402	8104,400	0,00
370.0	100,038	7903,263	0,00	1070.0	265,704	8106,995	0,00
380.0	102,120	7906,857	0,00	1080.0	268,002	8109,585	0,00
390.0	104,244	7910,415	0,00	1090.0	270,294	8112,169	0,00
400.0	106,407	7913,913	0,00	1100.0	272,583	8114,747	0,00
410.0	108,602	7917,356	0,00	1110.0	274,866	8117,320	0,00
420.0	110,828	7920,774	0,00	1120.0	277,145	8119,887	0,00
430.0	113,080	7924,145	0,00	1130.0	279,420	8122,449	0,00
440.0	115,356	7927,479	0,00	1140.0	281,690	8125,006	0,00
450.0	117,653	7930,780	0,00	1150.0	283,955	8127,557	0,00
460.0	119,968	7934,050	0,00	1160.0	286,215	8130,103	0,00
470.0	122,300	7937,291	0,00	1170.0	288,471	8132,644	0,00
480.0	124,646	7940,504	0,00	1180.0	290,722	8135,180	0,00
490.0	127,006	7943,693	0,00	1190.0	292,938	8137,710	0,00
500.0	129,377	7946,857	0,00	1200.0	295,210	8140,235	0,00
510.0	131,758	7949,999	0,00	1210.0	297,447	8142,755	0,00
520.0	134,148	7953,120	0,00	1220.0	299,679	8145,270	0,00
530.0	136,547	7956,221	0,00	1230.0	301,907	8147,780	0,00
540.0	138,952	7959,303	0,00	1240.0	304,130	8150,285	0,00
550.0	141,363	7962,366	0,00	1250.0	306,348	8152,785	0,00
560.0	143,780	7965,413	0,00	1260.0	308,561	8155,280	0,00
570.0	146,201	7968,442	0,00	1270.0	310,770	8157,770	0,00
580.0	148,625	7971,457	0,00	1280.0	312,974	8160,255	0,00
590.0	151,053	7974,455	0,00	1290.0	315,173	8162,736	0,00
600.0	153,484	7977,440	0,00	1300.0	317,368	8165,211	0,00
610.0	155,916	7980,411	0,00	1310.0	319,558	8167,682	0,00
620.0	158,350	7983,368	0,00	1320.0	321,743	8170,148	0,00
630.0	160,785	7986,312	0,00	1330.0	323,924	8172,609	0,00
640.0	163,222	7989,244	0,00	1340.0	326,099	8175,065	0,00
650.0	165,658	7992,164	0,00	1350.0	328,271	8177,517	0,00
660.0	168,094	7995,072	0,00	1360.0	330,437	8179,964	0,00
670.0	170,530	7997,969	0,00	1370.0	332,599	8182,407	0,00
680.0	172,956	8000,855	0,00	1380.0	334,756	8184,844	0,00
690.0	175,400	8003,730	0,00	1390.0	336,908	8187,278	0,00
700.0	177,833	8006,595	0,00	1400.0	339,056	8189,705	0,00
710.0	180,265	8009,450	0,00	1410.0	341,199	8192,130	0,00
720.0	182,695	8012,296	0,00	1420.0	343,337	8194,550	0,00
730.0	185,123	8015,131	0,00	1430.0	345,471	8196,964	0,00
740.0	187,549	8017,958	0,00	1440.0	347,600	8199,375	0,00
750.0	189,973	8020,775	0,00	1450.0	349,724	8201,781	0,00
760.0	192,395	8023,583	0,00	1460.0	351,844	8204,182	0,00
770.0	194,814	8026,383	0,00	1470.0	353,959	8206,580	0,00
780.0	197,230	8029,174	0,00	1480.0	356,069	8208,972	0,00
790.0	199,643	8031,957	0,00	1490.0	358,175	8211,360	0,00
800.0	202,054	8034,732	0,00	1500.0	360,276	8213,744	0,00

Угол входа — 1,3 град

Н, км	DVT, м/с	VВХ, м/с	ТЕТА, ГРАД	Н, км	DVT, м/с	VВХ, м/с	ТЕТА, ГРАД
110,0	585,867	7265,099	83,34	810,0	205,927	8036,178	0,00
120,0	314,647	7542,371	78,82	820,0	208,312	8038,956	0,00
130,0	219,098	7643,945	68,97	830,0	210,694	8041,726	0,00
140,0	171,345	7697,705	54,16	840,0	213,074	8044,487	0,00
150,0	143,395	7731,649	30,74	850,0	215,450	8047,241	0,00
160,0	125,541	7755,481	0,00	860,0	217,824	8049,986	0,00
170,0	113,529	7773,458	0,00	870,0	220,194	8052,724	0,00
180,0	105,198	7787,739	0,00	880,0	222,560	8055,455	0,00
190,0	99,335	7799,539	0,00	890,0	224,924	8058,178	0,00
200,0	95,207	7809,590	0,00	900,0	227,283	8060,894	0,00
210,0	92,344	7818,363	0,00	910,0	229,640	8063,602	0,00
220,0	90,430	7826,172	0,00	920,0	231,992	8066,304	0,00
230,0	89,247	7833,237	0,00	930,0	234,341	8068,998	0,00
240,0	88,639	7839,715	0,00	940,0	236,686	8071,685	0,00
250,0	88,489	7845,720	0,00	950,0	239,027	8074,367	0,00
260,0	88,711	7851,340	0,00	960,0	241,365	8077,041	0,00
270,0	89,238	7856,641	0,00	970,0	243,698	8079,709	0,00
280,0	90,020	7861,676	0,00	980,0	246,027	8082,370	0,00
290,0	91,014	7866,484	0,00	990,0	248,353	8085,025	0,00
300,0	92,187	7871,100	0,00	1000,0	250,674	8087,673	0,00
310,0	93,514	7875,549	0,00	1010,0	252,991	8090,315	0,00
320,0	94,973	7879,854	0,00	1020,0	255,301	8092,950	0,00
330,0	96,545	7884,032	0,00	1030,0	257,613	8095,580	0,00
340,0	98,215	7888,099	0,00	1040,0	259,917	8098,203	0,00
350,0	99,972	7892,067	0,00	1050,0	262,217	8100,821	0,00
360,0	101,803	7895,946	0,00	1060,0	264,513	8103,432	0,00
370,0	103,700	7899,748	0,00	1070,0	266,805	8106,038	0,00
380,0	105,656	7903,478	0,00	1080,0	269,092	8108,637	0,00
390,0	107,663	7907,143	0,00	1090,0	271,375	8111,231	0,00
400,0	109,716	7910,751	0,00	1100,0	273,654	8113,819	0,00
410,0	111,810	7914,305	0,00	1110,0	275,928	8116,402	0,00
420,0	113,939	7917,810	0,00	1120,0	278,197	8118,979	0,00
430,0	116,101	7921,271	0,00	1130,0	280,462	8121,550	0,00
440,0	118,292	7924,690	0,00	1140,0	282,723	8124,115	0,00
450,0	120,508	7928,071	0,00	1150,0	284,979	8126,676	0,00
460,0	122,747	7931,417	0,00	1160,0	287,231	8129,230	0,00
470,0	125,007	7934,730	0,00	1170,0	289,478	8131,780	0,00
480,0	127,285	7938,011	0,00	1180,0	291,721	8134,323	0,00
490,0	129,581	7941,264	0,00	1190,0	293,959	8136,852	0,00
500,0	131,890	7944,490	0,00	1200,0	296,193	8139,395	0,00
510,0	134,213	7947,691	0,00	1210,0	298,422	8141,923	0,00
520,0	136,548	7950,867	0,00	1220,0	300,646	8144,446	0,00
530,0	138,893	7954,021	0,00	1230,0	302,856	8146,963	0,00
540,0	141,248	7957,153	0,00	1240,0	305,082	8149,476	0,00
550,0	143,611	7960,265	0,00	1250,0	307,292	8151,983	0,00
560,0	145,981	7963,358	0,00	1260,0	309,498	8154,485	0,00
570,0	148,358	7966,432	0,00	1270,0	311,700	8156,983	0,00
580,0	150,740	7969,488	0,00	1280,0	313,897	8159,475	0,00
590,0	153,127	7972,528	0,00	1290,0	316,089	8161,962	0,00
600,0	155,518	7975,552	0,00	1300,0	318,277	8164,444	0,00
610,0	157,913	7978,560	0,00	1310,0	320,461	8166,922	0,00
620,0	160,311	7981,553	0,00	1320,0	322,639	8169,394	0,00
630,0	162,712	7984,532	0,00	1330,0	324,813	8171,862	0,00
640,0	165,114	7987,498	0,00	1340,0	326,983	8174,324	0,00
650,0	167,518	7990,450	0,00	1350,0	329,147	8176,782	0,00
660,0	169,923	7993,389	0,00	1360,0	331,308	8179,236	0,00
670,0	172,329	7996,316	0,00	1370,0	333,463	8181,684	0,00
680,0	174,735	7999,231	0,00	1380,0	335,614	8184,128	0,00
690,0	177,141	8002,135	0,00	1390,0	337,761	8186,567	0,00
700,0	179,547	8005,027	0,00	1400,0	339,903	8188,001	0,00
710,0	181,953	8007,908	0,00	1410,0	342,040	8191,431	0,00
720,0	184,367	8010,779	0,00	1420,0	344,172	8193,856	0,00
730,0	185,761	8013,639	0,00	1430,0	346,301	8195,276	0,00
740,0	189,163	8016,489	0,00	1440,0	348,424	8198,692	0,00
750,0	191,564	8019,330	0,00	1450,0	350,543	8201,103	0,00
760,0	193,963	8022,160	0,00	1460,0	352,657	8203,510	0,00
770,0	196,360	8024,982	0,00	1470,0	354,767	8205,912	0,00
780,0	198,756	8027,794	0,00	1480,0	356,872	8208,310	0,00
790,0	201,148	8030,598	0,00	1490,0	358,973	8210,703	0,00
800,0	203,539	8033,392	0,00	1500,0	361,069	8213,092	0,00

## Угол входа — 1,4 град

Н, км	DVT, м/с	VBX, м/с	ТЕТА, ГРАД	Н, км	DVT, м/с	VBX, м/с	ТЕТА, ГРАД
110.0	667.485	7183.630	83.03	810.0	207.509	8034.753	0.00
120.0	360.665	7496.506	79.62	820.0	209.874	8037.551	0.00
130.0	251.125	7612.074	71.29	830.0	212.236	8040.340	0.00
140.0	195.913	7673.295	58.81	840.0	214.598	8043.121	0.00
150.0	163.329	7711.873	40.59	850.0	216.954	8045.893	0.00
160.0	142.318	7738.863	0.00	860.0	219.309	8048.657	0.00
170.0	128.015	7759.130	0.00	870.0	221.661	8051.413	0.00
180.0	117.948	7775.148	0.00	880.0	224.011	8054.161	0.00
190.0	110.723	7788.310	0.00	890.0	226.357	8056.901	0.00
200.0	105.498	7799.458	0.00	900.0	228.700	8059.633	0.00
210.0	101.732	7809.134	0.00	910.0	231.041	8062.357	0.00
220.0	99.063	7817.698	0.00	920.0	233.377	8065.075	0.00
230.0	97.239	7825.405	0.00	930.0	235.711	8067.784	0.00
240.0	96.079	7832.434	0.00	940.0	238.041	8070.487	0.00
250.0	95.450	7838.919	0.00	950.0	240.368	8073.182	0.00
260.0	95.251	7844.959	0.00	960.0	242.691	8075.871	0.00
270.0	95.407	7850.632	0.00	970.0	245.010	8078.552	0.00
280.0	95.857	7855.998	0.00	980.0	247.326	8081.227	0.00
290.0	96.554	7861.103	0.00	990.0	249.638	8083.895	0.00
300.0	97.460	7865.986	0.00	1000.0	251.946	8086.556	0.00
310.0	98.545	7870.678	0.00	1010.0	254.251	8089.211	0.00
320.0	99.783	7875.203	0.00	1020.0	256.551	8091.859	0.00
330.0	101.153	7879.583	0.00	1030.0	258.848	8094.501	0.00
340.0	102.639	7883.834	0.00	1040.0	261.140	8097.136	0.00
350.0	104.225	7887.973	0.00	1050.0	263.429	8099.765	0.00
360.0	105.899	7892.010	0.00	1060.0	265.713	8102.388	0.00
370.0	107.650	7895.957	0.00	1070.0	267.993	8105.004	0.00
380.0	109.470	7899.822	0.00	1080.0	270.270	8107.615	0.00
390.0	111.351	7903.614	0.00	1090.0	272.542	8110.220	0.00
400.0	113.286	7907.340	0.00	1100.0	274.810	8112.818	0.00
410.0	115.269	7911.004	0.00	1110.0	277.073	8115.411	0.00
420.0	117.295	7914.613	0.00	1120.0	279.333	8117.998	0.00
430.0	119.360	7918.171	0.00	1130.0	281.588	8120.579	0.00
440.0	121.459	7921.682	0.00	1140.0	283.839	8123.154	0.00
450.0	123.588	7925.150	0.00	1150.0	286.086	8125.724	0.00
460.0	125.746	7928.577	0.00	1160.0	288.328	8128.288	0.00
470.0	127.929	7931.967	0.00	1170.0	290.566	8130.846	0.00
480.0	130.134	7935.322	0.00	1180.0	292.800	8133.399	0.00
490.0	132.359	7938.644	0.00	1190.0	295.029	8135.946	0.00
500.0	134.603	7941.936	0.00	1200.0	297.254	8138.488	0.00
510.0	136.863	7945.200	0.00	1210.0	299.474	8141.025	0.00
520.0	139.138	7948.436	0.00	1220.0	301.690	8143.556	0.00
530.0	141.426	7951.647	0.00	1230.0	303.902	8146.082	0.00
540.0	143.726	7954.834	0.00	1240.0	306.109	8148.602	0.00
550.0	146.036	7957.998	0.00	1250.0	308.312	8151.118	0.00
560.0	148.357	7961.140	0.00	1260.0	310.510	8153.628	0.00
570.0	150.685	7964.262	0.00	1270.0	312.704	8156.132	0.00
580.0	153.022	7967.364	0.00	1280.0	314.894	8158.632	0.00
590.0	155.365	7970.448	0.00	1290.0	317.078	8161.127	0.00
600.0	157.714	7973.514	0.00	1300.0	319.259	8163.616	0.00
610.0	160.068	7976.563	0.00	1310.0	321.435	8166.101	0.00
620.0	162.427	7979.595	0.00	1320.0	323.606	8168.580	0.00
630.0	164.790	7982.612	0.00	1330.0	325.773	8171.055	0.00
640.0	167.156	7985.613	0.00	1340.0	327.936	8173.524	0.00
650.0	169.525	7988.600	0.00	1350.0	330.094	8175.989	0.00
660.0	171.897	7991.573	0.00	1360.0	332.248	8178.449	0.00
670.0	174.270	7994.532	0.00	1370.0	334.397	8180.904	0.00
680.0	176.645	7997.479	0.00	1380.0	336.541	8183.354	0.00
690.0	179.021	8000.412	0.00	1390.0	338.681	8185.799	0.00
700.0	181.398	8003.334	0.00	1400.0	340.817	8188.240	0.00
710.0	183.775	8006.243	0.00	1410.0	342.948	8190.675	0.00
720.0	186.152	8009.141	0.00	1420.0	345.075	8193.105	0.00
730.0	188.529	8012.028	0.00	1430.0	347.197	8195.533	0.00
740.0	190.905	8014.904	0.00	1440.0	349.314	8197.955	0.00
750.0	193.281	8017.769	0.00	1450.0	351.427	8200.372	0.00
760.0	195.656	8020.624	0.00	1460.0	353.536	8202.784	0.00
770.0	198.030	8023.469	0.00	1470.0	355.640	8205.192	0.00
780.0	200.402	8026.305	0.00	1480.0	357.740	8207.595	0.00
790.0	202.773	8029.130	0.00	1490.0	359.835	8209.994	0.00
800.0	205.142	8031.946	0.00	1500.0	361.926	8212.388	0.00

## Угол входа — 1,5 град

Н, км	DVT, м/с	VBX, м/с	ТЕТА, ГРАД	Н, км	DVT, м/с	VBX, м/с	ТЕТА, ГРАД
110.0	752.161	7099.111	82.64	810.0	209.207	8033.223	0.00
120.0	409.169	7448.168	80.19	820.0	211.550	8036.043	0.00
130.0	285.083	7578.284	73.10	830.0	213.891	8038.853	0.00
140.0	222.042	7647.335	62.40	840.0	216.231	8041.655	0.00
150.0	184.570	7690.802	47.38	850.0	218.568	8044.447	0.00
160.0	160.217	7721.134	22.60	860.0	220.904	8047.230	0.00
170.0	143.486	7743.830	0.00	870.0	223.237	8050.005	0.00
180.0	131.573	7761.694	0.00	880.0	225.568	8052.771	0.00
190.0	122.930	7776.304	0.00	890.0	227.896	8055.529	0.00
200.0	116.507	7788.620	0.00	900.0	230.222	8058.279	0.00
210.0	111.779	7799.257	0.00	910.0	232.545	8061.021	0.00
220.0	108.305	7808.628	0.00	920.0	234.855	8063.755	0.00
230.0	105.796	7817.019	0.00	930.0	237.182	8066.481	0.00
240.0	104.047	7824.637	0.00	940.0	239.495	8069.200	0.00
250.0	102.935	7831.634	0.00	950.0	241.807	8071.911	0.00
260.0	102.258	7838.123	0.00	960.0	244.114	8074.614	0.00
270.0	102.017	7844.194	0.00	970.0	246.419	8077.311	0.00
280.0	102.113	7849.913	0.00	980.0	248.720	8080.000	0.00
290.0	102.492	7855.336	0.00	990.0	251.018	8082.682	0.00
300.0	103.113	7860.505	0.00	1000.0	253.312	8085.357	0.00
310.0	103.938	7865.456	0.00	1010.0	255.603	8088.025	0.00
320.0	104.940	7870.217	0.00	1020.0	257.890	8090.687	0.00
330.0	106.095	7874.812	0.00	1030.0	260.173	8093.342	0.00
340.0	107.382	7879.262	0.00	1040.0	262.453	8095.990	0.00
350.0	108.785	7883.583	0.00	1050.0	264.729	8098.631	0.00
360.0	110.291	7887.788	0.00	1060.0	267.001	8101.266	0.00
370.0	111.895	7891.892	0.00	1070.0	269.269	8103.895	0.00
380.0	113.561	7895.902	0.00	1080.0	271.534	8106.517	0.00
390.0	115.307	7899.830	0.00	1090.0	273.794	8109.133	0.00
400.0	117.115	7903.681	0.00	1100.0	276.051	8111.743	0.00
410.0	118.980	7907.464	0.00	1110.0	278.304	8114.347	0.00
420.0	120.895	7911.184	0.00	1120.0	280.552	8116.945	0.00
430.0	122.855	7914.846	0.00	1130.0	282.797	8119.536	0.00
440.0	124.856	7918.455	0.00	1140.0	285.037	8122.122	0.00
450.0	126.893	7922.015	0.00	1150.0	287.274	8124.702	0.00
460.0	128.963	7925.530	0.00	1160.0	289.506	8127.276	0.00
470.0	131.053	7929.003	0.00	1170.0	291.734	8129.844	0.00
480.0	133.190	7932.436	0.00	1180.0	293.958	8132.407	0.00
490.0	135.340	7935.833	0.00	1190.0	296.177	8134.964	0.00
500.0	137.513	7939.195	0.00	1200.0	298.393	8137.515	0.00
510.0	139.705	7942.527	0.00	1210.0	300.604	8140.060	0.00
520.0	141.916	7945.827	0.00	1220.0	302.811	8142.601	0.00
530.0	144.143	7949.100	0.00	1230.0	305.014	8145.135	0.00
540.0	146.384	7952.345	0.00	1240.0	307.213	8147.664	0.00
550.0	148.639	7955.565	0.00	1250.0	309.407	8150.188	0.00
560.0	150.906	7958.761	0.00	1260.0	311.597	8152.707	0.00
570.0	153.183	7961.934	0.00	1270.0	313.782	8155.220	0.00
580.0	155.471	7965.085	0.00	1280.0	315.953	8157.727	0.00
590.0	157.766	7968.216	0.00	1290.0	318.140	8160.230	0.00
600.0	160.070	7971.327	0.00	1300.0	320.313	8162.727	0.00
610.0	162.381	7974.419	0.00	1310.0	322.481	8165.220	0.00
620.0	164.698	7977.493	0.00	1320.0	324.645	8167.707	0.00
630.0	167.021	7980.550	0.00	1330.0	326.805	8170.189	0.00
640.0	169.348	7983.591	0.00	1340.0	328.960	8172.665	0.00
650.0	171.680	7986.615	0.00	1350.0	331.110	8175.137	0.00
660.0	174.015	7989.624	0.00	1360.0	333.257	8177.604	0.00
670.0	176.354	7992.618	0.00	1370.0	335.399	8180.066	0.00
680.0	178.695	7995.598	0.00	1380.0	337.537	8182.523	0.00
690.0	181.038	7998.564	0.00	1390.0	339.670	8184.975	0.00
700.0	183.383	8001.517	0.00	1400.0	341.799	8187.422	0.00
710.0	185.730	8004.457	0.00	1410.0	343.923	8189.865	0.00
720.0	188.078	8007.384	0.00	1420.0	346.043	8192.302	0.00
730.0	190.426	8010.299	0.00	1430.0	348.159	8194.735	0.00
740.0	192.775	8013.203	0.00	1440.0	350.270	8197.163	0.00
750.0	195.124	8016.095	0.00	1450.0	352.377	8199.586	0.00
760.0	197.473	8018.976	0.00	1460.0	354.480	8202.004	0.00
770.0	199.822	8021.846	0.00	1470.0	356.578	8204.418	0.00
780.0	202.170	8024.705	0.00	1480.0	358.671	8206.827	0.00
790.0	204.516	8027.555	0.00	1490.0	360.761	8209.232	0.00
800.0	206.862	8030.394	0.00	1500.0	362.846	8211.632	0.00



## Угол входа — 1,6 град

Н, км	DVT, м/с	VBX, м/с	ТЕТА, ГРАД	Н, км	DVT, м/с	VBX, м/с	ТЕТА, ГРАД
110.0	839.450	7011.989	82.19	810.0	211.021	8031.589	0.00
120.0	459.994	7397.518	80.57	820.0	213.341	8034.432	0.00
130.0	320.886	7542.659	74.52	830.0	215.659	8037.265	0.00
140.0	249.682	7619.875	65.25	840.0	217.977	8040.088	0.00
150.0	207.084	7668.468	52.49	850.0	220.293	8042.902	0.00
160.0	179.215	7702.318	33.91	860.0	222.608	8045.706	0.00
170.0	159.922	7727.576	0.00	870.0	224.920	8048.501	0.00
180.0	146.060	7747.388	0.00	880.0	227.231	8051.287	0.00
190.0	135.854	7763.532	0.00	890.0	229.540	8054.064	0.00
200.0	128.224	7777.086	0.00	900.0	231.847	8056.833	0.00
210.0	122.477	7788.742	0.00	910.0	234.151	8059.593	0.00
220.0	118.148	7798.967	0.00	920.0	236.453	8062.345	0.00
230.0	114.913	7808.085	0.00	930.0	238.753	8065.089	0.00
240.0	112.538	7816.328	0.00	940.0	241.050	8067.824	0.00
250.0	110.853	7823.869	0.00	950.0	243.344	8070.552	0.00
260.0	109.728	7830.836	0.00	960.0	245.636	8073.272	0.00
270.0	109.064	7837.329	0.00	970.0	247.924	8075.984	0.00
280.0	108.784	7843.425	0.00	980.0	250.210	8078.689	0.00
290.0	108.826	7849.185	0.00	990.0	252.492	8081.386	0.00
300.0	109.142	7854.659	0.00	1000.0	254.771	8084.076	0.00
310.0	109.691	7859.885	0.00	1010.0	257.047	8086.759	0.00
320.0	110.442	7864.898	0.00	1020.0	259.320	8089.435	0.00
330.0	111.367	7869.723	0.00	1030.0	261.590	8092.103	0.00
340.0	112.443	7874.384	0.00	1040.0	263.856	8094.765	0.00
350.0	113.652	7878.898	0.00	1050.0	266.118	8097.420	0.00
360.0	114.978	7883.284	0.00	1060.0	268.377	8100.068	0.00
370.0	116.407	7887.553	0.00	1070.0	270.633	8102.710	0.00
380.0	117.927	7891.718	0.00	1080.0	272.885	8105.344	0.00
390.0	119.529	7895.790	0.00	1090.0	275.133	8107.973	0.00
400.0	121.203	7899.776	0.00	1100.0	277.377	8110.595	0.00
410.0	122.942	7903.685	0.00	1110.0	279.618	8113.210	0.00
420.0	124.738	7907.523	0.00	1120.0	281.855	8115.819	0.00
430.0	126.587	7911.296	0.00	1130.0	284.088	8118.423	0.00
440.0	128.483	7915.010	0.00	1140.0	286.317	8121.019	0.00
450.0	130.422	7918.669	0.00	1150.0	288.543	8123.610	0.00
460.0	132.398	7922.277	0.00	1160.0	290.764	8126.195	0.00
470.0	134.410	7925.838	0.00	1170.0	292.982	8128.774	0.00
480.0	136.452	7929.356	0.00	1180.0	295.195	8131.346	0.00
490.0	138.524	7932.832	0.00	1190.0	297.405	8133.913	0.00
500.0	140.621	7936.270	0.00	1200.0	299.610	8136.475	0.00
510.0	142.741	7939.673	0.00	1210.0	301.812	8139.030	0.00
520.0	144.883	7943.042	0.00	1220.0	304.009	8141.580	0.00
530.0	147.045	7946.379	0.00	1230.0	306.202	8144.124	0.00
540.0	149.224	7949.687	0.00	1240.0	308.392	8146.662	0.00
550.0	151.419	7952.967	0.00	1250.0	310.577	8149.195	0.00
560.0	153.628	7956.220	0.00	1260.0	312.757	8151.722	0.00
570.0	155.851	7959.447	0.00	1270.0	314.934	8154.244	0.00
580.0	158.086	7962.651	0.00	1280.0	317.107	8156.761	0.00
590.0	160.332	7965.832	0.00	1290.0	319.275	8159.272	0.00
600.0	162.587	7968.992	0.00	1300.0	321.439	8161.777	0.00
610.0	164.851	7972.130	0.00	1310.0	323.599	8164.278	0.00
620.0	167.124	7975.249	0.00	1320.0	325.755	8166.773	0.00
630.0	169.403	7978.349	0.00	1330.0	327.906	8169.263	0.00
640.0	171.689	7981.430	0.00	1340.0	330.054	8171.748	0.00
650.0	173.981	7984.495	0.00	1350.0	332.197	8174.227	0.00
660.0	176.278	7987.642	0.00	1360.0	334.335	8176.702	0.00
670.0	178.579	7990.773	0.00	1370.0	336.470	8179.171	0.00
680.0	180.884	7993.889	0.00	1380.0	338.600	8181.635	0.00
690.0	183.193	7996.990	0.00	1390.0	340.725	8184.094	0.00
700.0	185.505	7999.576	0.00	1400.0	342.848	8186.549	0.00
710.0	187.819	8002.548	0.00	1410.0	344.965	8188.998	0.00
720.0	190.135	8005.507	0.00	1420.0	347.078	8191.442	0.00
730.0	192.453	8008.453	0.00	1430.0	349.187	8193.882	0.00
740.0	194.773	8011.386	0.00	1440.0	351.292	8196.317	0.00
750.0	197.093	8014.306	0.00	1450.0	353.392	8198.746	0.00
760.0	199.414	8017.215	0.00	1460.0	355.488	8201.171	0.00
770.0	201.736	8020.112	0.00	1470.0	357.579	8203.592	0.00
780.0	204.058	8022.997	0.00	1480.0	359.667	8206.007	0.00
790.0	206.379	8025.872	0.00	1490.0	361.750	8208.418	0.00
800.0	208.700	8028.736	0.00	1500.0	363.828	8210.824	0.00

## Угол входа — 1.7 град

Н, км	DVT, м/с	VBX, м/с	ТЕТА, ГРАД	Н, км	DVT, м/с	VBX, м/с	ТЕТА, ГРАД
110.0	928.927	6922.687	81.69	810.0	212.951	8029.850	0.00
120.0	512.973	7344.724	80.81	820.0	215.246	8032.718	0.00
130.0	358.449	7505.285	75.64	830.0	217.541	8035.575	0.00
140.0	278.779	7590.968	67.54	840.0	219.835	8038.422	0.00
150.0	230.836	7644.908	56.49	850.0	222.128	8041.258	0.00
160.0	199.286	7682.439	41.30	860.0	224.420	8044.084	0.00
170.0	177.305	7710.385	13.19	870.0	226.711	8046.901	0.00
180.0	161.394	7732.248	0.00	880.0	229.001	8049.708	0.00
190.0	149.574	7750.006	0.00	890.0	231.289	8052.506	0.00
200.0	140.639	7764.834	0.00	900.0	233.576	8055.295	0.00
210.0	133.817	7777.596	0.00	910.0	235.861	8058.074	0.00
220.0	128.586	7788.723	0.00	920.0	238.144	8060.845	0.00
230.0	124.583	7798.608	0.00	930.0	240.425	8063.608	0.00
240.0	121.548	7807.513	0.00	940.0	242.704	8066.361	0.00
250.0	119.287	7815.629	0.00	950.0	244.980	8069.107	0.00
260.0	117.657	7823.102	0.00	960.0	247.254	8071.844	0.00
270.0	116.546	7830.042	0.00	970.0	249.525	8074.573	0.00
280.0	115.867	7836.536	0.00	980.0	251.794	8077.294	0.00
290.0	115.551	7842.654	0.00	990.0	254.061	8080.008	0.00
300.0	115.545	7848.450	0.00	1000.0	256.324	8082.714	0.00
310.0	115.802	7853.969	0.00	1010.0	258.585	8085.412	0.00
320.0	116.286	7859.248	0.00	1020.0	260.842	8088.103	0.00
330.0	116.967	7864.316	0.00	1030.0	263.097	8090.785	0.00
340.0	117.820	7869.201	0.00	1040.0	265.348	8093.462	0.00
350.0	118.823	7873.921	0.00	1050.0	267.597	8096.131	0.00
360.0	119.959	7878.497	0.00	1060.0	269.842	8098.793	0.00
370.0	121.211	7882.943	0.00	1070.0	272.083	8101.448	0.00
380.0	122.568	7887.272	0.00	1080.0	274.322	8104.097	0.00
390.0	124.016	7891.497	0.00	1090.0	276.557	8106.738	0.00
400.0	125.547	7895.626	0.00	1100.0	278.789	8109.373	0.00
410.0	127.152	7899.668	0.00	1110.0	281.017	8112.001	0.00
420.0	128.823	7903.632	0.00	1120.0	283.241	8114.622	0.00
430.0	130.554	7907.523	0.00	1130.0	285.462	8117.237	0.00
440.0	132.339	7911.348	0.00	1140.0	287.680	8119.846	0.00
450.0	134.172	7915.112	0.00	1150.0	289.893	8122.448	0.00
460.0	136.050	7918.819	0.00	1160.0	292.103	8125.045	0.00
470.0	137.968	7922.474	0.00	1170.0	294.310	8127.634	0.00
480.0	139.921	7926.080	0.00	1180.0	296.512	8130.218	0.00
490.0	141.908	7929.641	0.00	1190.0	298.711	8132.795	0.00
500.0	143.925	7933.159	0.00	1200.0	300.906	8135.368	0.00
510.0	145.969	7936.638	0.00	1210.0	303.097	8137.934	0.00
520.0	148.038	7940.080	0.00	1220.0	305.284	8140.493	0.00
530.0	150.130	7943.487	0.00	1230.0	307.467	8143.047	0.00
540.0	152.243	7946.861	0.00	1240.0	309.646	8145.595	0.00
550.0	154.375	7950.204	0.00	1250.0	311.821	8148.138	0.00
560.0	156.524	7953.517	0.00	1260.0	313.993	8150.675	0.00
570.0	158.688	7956.803	0.00	1270.0	316.160	8153.205	0.00
580.0	160.867	7960.063	0.00	1280.0	318.323	8155.732	0.00
590.0	163.059	7963.297	0.00	1290.0	320.483	8158.252	0.00
600.0	165.264	7966.508	0.00	1300.0	322.638	8160.767	0.00
610.0	167.479	7969.696	0.00	1310.0	324.789	8163.276	0.00
620.0	169.703	7972.862	0.00	1320.0	326.936	8165.779	0.00
630.0	171.937	7976.007	0.00	1330.0	329.079	8168.278	0.00
640.0	174.179	7979.133	0.00	1340.0	331.218	8170.771	0.00
650.0	176.428	7982.239	0.00	1350.0	333.352	8173.259	0.00
660.0	178.684	7985.328	0.00	1360.0	335.483	8175.741	0.00
670.0	180.946	7988.398	0.00	1370.0	337.610	8178.218	0.00
680.0	183.213	7991.452	0.00	1380.0	339.732	8180.690	0.00
690.0	185.485	7994.490	0.00	1390.0	341.850	8183.157	0.00
700.0	187.761	7997.512	0.00	1400.0	343.964	8185.619	0.00
710.0	190.041	8000.518	0.00	1410.0	346.074	8188.076	0.00
720.0	192.324	8003.511	0.00	1420.0	348.180	8190.528	0.00
730.0	194.610	8006.488	0.00	1430.0	350.281	8192.975	0.00
740.0	196.898	8009.453	0.00	1440.0	352.379	8195.416	0.00
750.0	199.188	8012.404	0.00	1450.0	354.472	8197.853	0.00
760.0	201.479	8015.341	0.00	1460.0	356.561	8200.285	0.00
770.0	203.772	8018.267	0.00	1470.0	358.645	8202.712	0.00
780.0	206.066	8021.180	0.00	1480.0	360.726	8205.134	0.00
790.0	208.361	8024.082	0.00	1490.0	362.802	8207.552	0.00
800.0	210.656	8026.972	0.00	1500.0	364.874	8209.964	0.00

## Угол входа — 1.8 град

<i>H</i> , км	<i>DVT</i> , м/с	<i>VBX</i> , м/с	<i>ТЕТА</i> , ГРАД	<i>H</i> , км	<i>DVT</i> , м/с	<i>VBX</i> , м/с	<i>ТЕТА</i> , ГРАД
110.0	1020.187	6831.160	81.15	810.0	214.997	8028.008	0.00
120.0	567.941	7289.950	80.93	820.0	217.265	8030.901	0.00
130.0	397.684	7466.248	76.52	830.0	219.534	8033.784	0.00
140.0	309.280	7560.668	69.40	840.0	221.804	8036.655	0.00
150.0	255.789	7620.157	59.72	850.0	224.073	8039.516	0.00
160.0	220.404	7661.524	46.81	860.0	226.341	8042.365	0.00
170.0	195.615	7692.280	27.50	870.0	228.610	8045.205	0.00
180.0	177.559	7716.288	0.00	880.0	230.877	8048.035	0.00
190.0	164.047	7735.738	0.00	890.0	233.143	8050.854	0.00
200.0	153.744	7751.965	0.00	900.0	235.409	8053.664	0.00
210.0	145.791	7765.827	0.00	910.0	237.673	8056.464	0.00
220.0	139.612	7777.903	0.00	920.0	239.936	8059.256	0.00
230.0	134.801	7788.596	0.00	930.0	242.197	8062.037	0.00
240.0	131.070	7798.197	0.00	940.0	244.456	8064.810	0.00
250.0	128.203	7806.919	0.00	950.0	246.714	8067.575	0.00
260.0	126.040	7814.924	0.00	960.0	248.969	8070.330	0.00
270.0	124.458	7822.336	0.00	970.0	251.223	8073.077	0.00
280.0	123.358	7829.251	0.00	980.0	253.474	8075.816	0.00
290.0	122.666	7835.745	0.00	990.0	255.723	8078.547	0.00
300.0	122.319	7841.882	0.00	1000.0	257.970	8081.269	0.00
310.0	122.267	7847.709	0.00	1010.0	260.214	8083.984	0.00
320.0	122.471	7853.269	0.00	1020.0	262.456	8086.691	0.00
330.0	122.895	7858.595	0.00	1030.0	264.694	8089.390	0.00
340.0	123.512	7863.715	0.00	1040.0	266.930	8092.081	0.00
350.0	124.297	7868.653	0.00	1050.0	269.164	8094.765	0.00
360.0	125.232	7873.430	0.00	1060.0	271.394	8097.442	0.00
370.0	126.298	7878.063	0.00	1070.0	273.621	8100.111	0.00
380.0	127.480	7882.565	0.00	1080.0	275.846	8102.774	0.00
390.0	128.767	7886.951	0.00	1090.0	278.067	8105.429	0.00
400.0	130.147	7891.231	0.00	1100.0	280.285	8108.077	0.00
410.0	131.611	7895.415	0.00	1110.0	282.499	8110.719	0.00
420.0	133.149	7899.512	0.00	1120.0	284.711	8113.353	0.00
430.0	134.755	7903.528	0.00	1130.0	286.919	8115.981	0.00
440.0	136.423	7907.470	0.00	1140.0	289.124	8118.602	0.00
450.0	138.145	7911.345	0.00	1150.0	291.325	8121.217	0.00
460.0	139.918	7915.157	0.00	1160.0	293.523	8123.825	0.00
470.0	141.736	7918.911	0.00	1170.0	295.717	8126.427	0.00
480.0	143.596	7922.611	0.00	1180.0	297.908	8129.022	0.00
490.0	145.493	7926.261	0.00	1190.0	300.095	8131.611	0.00
500.0	147.423	7929.864	0.00	1200.0	302.279	8134.194	0.00
510.0	149.389	7933.424	0.00	1210.0	304.459	8136.771	0.00
520.0	151.381	7936.943	0.00	1220.0	306.635	8139.342	0.00
530.0	153.399	7940.423	0.00	1230.0	308.807	8141.907	0.00
540.0	155.442	7943.867	0.00	1240.0	310.976	8144.465	0.00
550.0	157.506	7947.277	0.00	1250.0	313.141	8147.018	0.00
560.0	159.591	7950.655	0.00	1260.0	315.302	8149.565	0.00
570.0	161.694	7954.002	0.00	1270.0	317.460	8152.106	0.00
580.0	163.814	7957.320	0.00	1280.0	319.613	8154.641	0.00
590.0	165.950	7960.611	0.00	1290.0	321.763	8157.171	0.00
600.0	168.100	7963.876	0.00	1300.0	323.908	8159.695	0.00
610.0	170.262	7967.116	0.00	1310.0	326.050	8162.213	0.00
620.0	172.437	7970.333	0.00	1320.0	328.188	8164.726	0.00
630.0	174.622	7973.526	0.00	1330.0	330.322	8167.234	0.00
640.0	176.818	7976.698	0.00	1340.0	332.452	8169.735	0.00
650.0	179.022	7979.850	0.00	1350.0	334.578	8172.232	0.00
660.0	181.235	7982.981	0.00	1360.0	336.700	8174.723	0.00
670.0	183.455	7986.094	0.00	1370.0	338.818	8177.209	0.00
680.0	185.681	7989.188	0.00	1380.0	340.932	8179.689	0.00
690.0	187.914	7992.265	0.00	1390.0	343.042	8182.164	0.00
700.0	190.153	7995.324	0.00	1400.0	345.148	8184.634	0.00
710.0	192.396	7998.367	0.00	1410.0	347.250	8187.099	0.00
720.0	194.643	8001.395	0.00	1420.0	349.348	8189.558	0.00
730.0	196.895	8004.407	0.00	1430.0	351.441	8192.013	0.00
740.0	199.150	8007.404	0.00	1440.0	353.531	8194.462	0.00
750.0	201.408	8010.387	0.00	1450.0	355.617	8196.906	0.00
760.0	203.668	8013.356	0.00	1460.0	357.698	8199.345	0.00
770.0	205.931	8016.312	0.00	1470.0	359.776	8201.780	0.00
780.0	208.195	8019.255	0.00	1480.0	361.849	8204.209	0.00
790.0	210.461	8022.184	0.00	1490.0	363.918	8206.633	0.00
800.0	212.728	8025.102	0.00	1500.0	365.983	8209.053	0.00

## Угол входа — 1,9 град

Н, км	DVT, м/с	VBX, м/с	ТЕТА, ГРАД	Н, км	DVT, м/с	VBX, м/с	ТЕТА, ГРАД
110.0	1112,849	6739,139	80,58	810.0	217,157	8026,061	0,00
120.0	624,732	7233,363	80,96	820.0	219,398	8028,983	0,00
130.0	438,502	7425,640	77,21	830.0	221,641	8031,832	0,00
140.0	341,130	7529,030	70,93	840.0	223,884	8034,789	0,00
150.0	281,906	7594,254	62,36	850.0	226,127	8037,675	0,00
160.0	242,543	7639,600	51,14	860.0	228,371	8040,550	0,00
170.0	214,832	7673,278	35,67	870.0	230,615	8043,414	0,00
180.0	194,539	7699,524	0,00	880.0	232,859	8046,267	0,00
190.0	179,260	7720,741	0,00	890.0	235,102	8049,109	0,00
200.0	167,526	7738,399	0,00	900.0	237,345	8051,942	0,00
210.0	158,391	7753,444	0,00	910.0	239,587	8054,764	0,00
220.0	151,217	7766,514	0,00	920.0	241,829	8057,576	0,00
230.0	145,560	7778,054	0,00	930.0	244,069	8060,379	0,00
240.0	141,099	7788,385	0,00	940.0	246,308	8063,172	0,00
250.0	137,596	7797,743	0,00	950.0	248,546	8065,956	0,00
260.0	134,874	7806,307	0,00	960.0	250,782	8068,731	0,00
270.0	132,797	7814,214	0,00	970.0	253,016	8071,497	0,00
280.0	131,256	7821,571	0,00	980.0	255,249	8074,254	0,00
290.0	130,167	7828,462	0,00	990.0	257,480	8077,003	0,00
300.0	129,462	7834,956	0,00	1000.0	259,709	8079,743	0,00
310.0	129,086	7841,108	0,00	010.0	261,936	8082,475	0,00
320.0	128,993	7846,964	0,00	020.0	264,160	8085,199	0,00
330.0	129,147	7852,560	0,00	030.0	266,382	8087,914	0,00
340.0	129,515	7857,929	0,00	040.0	268,602	8090,622	0,00
350.0	130,072	7863,096	0,00	050.0	270,819	8093,322	0,00
360.0	130,795	7868,085	0,00	060.0	273,034	8096,014	0,00
370.0	131,664	7872,914	0,00	070.0	275,245	8098,699	0,00
380.0	132,664	7877,599	0,00	080.0	277,455	8101,376	0,00
390.0	133,781	7882,155	0,00	090.0	279,662	8104,046	0,00
400.0	135,002	7886,594	0,00	100.0	281,865	8106,709	0,00
410.0	136,316	7890,927	0,00	110.0	284,066	8109,364	0,00
420.0	137,715	7895,163	0,00	120.0	286,264	8112,012	0,00
430.0	139,190	7899,310	0,00	130.0	288,458	8114,654	0,00
440.0	140,733	7903,377	0,00	140.0	290,650	8117,288	0,00
450.0	142,339	7907,368	0,00	150.0	292,838	8119,916	0,00
460.0	144,001	7911,291	0,00	160.0	295,023	8122,537	0,00
470.0	145,715	7915,149	0,00	170.0	297,205	8125,151	0,00
480.0	147,475	7918,949	0,00	180.0	299,383	8127,759	0,00
490.0	149,278	7922,693	0,00	190.0	301,558	8130,360	0,00
500.0	151,121	7926,386	0,00	200.0	303,730	8132,955	0,00
510.0	152,999	7930,030	0,00	210.0	305,898	8135,543	0,00
520.0	154,910	7933,630	0,00	220.0	308,063	8138,125	0,00
530.0	156,851	7937,188	0,00	230.0	310,224	8140,701	0,00
540.0	158,819	7940,706	0,00	240.0	312,382	8143,271	0,00
550.0	160,813	7944,187	0,00	250.0	314,536	8145,834	0,00
560.0	162,830	7947,632	0,00	260.0	316,686	8148,392	0,00
570.0	164,868	7951,044	0,00	270.0	318,833	8150,943	0,00
580.0	166,926	7954,424	0,00	280.0	320,976	8153,489	0,00
590.0	169,002	7957,775	0,00	290.0	323,115	8156,029	0,00
600.0	171,095	7961,097	0,00	300.0	325,251	8158,563	0,00
610.0	173,202	7964,392	0,00	310.0	327,383	8161,091	0,00
620.0	175,324	7967,662	0,00	320.0	329,511	8163,613	0,00
630.0	177,458	7970,906	0,00	330.0	331,636	8166,130	0,00
640.0	179,604	7974,128	0,00	340.0	333,756	8168,641	0,00
650.0	181,761	7977,326	0,00	350.0	335,873	8171,147	0,00
660.0	183,928	7980,503	0,00	360.0	337,986	8173,647	0,00
670.0	186,104	7983,660	0,00	370.0	340,095	8176,142	0,00
680.0	188,288	7986,797	0,00	380.0	342,200	8178,631	0,00
690.0	190,480	7989,914	0,00	390.0	344,301	8181,114	0,00
700.0	192,678	7993,014	0,00	400.0	346,399	8183,593	0,00
710.0	194,883	7996,095	0,00	410.0	348,492	8186,066	0,00
720.0	197,093	7999,160	0,00	420.0	350,582	8188,533	0,00
730.0	199,309	8002,208	0,00	430.0	352,667	8190,996	0,00
740.0	201,528	8005,240	0,00	440.0	354,749	8193,453	0,00
750.0	203,752	8008,257	0,00	450.0	356,827	8195,905	0,00
760.0	205,980	8011,259	0,00	460.0	358,900	8198,352	0,00
770.0	208,210	8014,247	0,00	470.0	360,970	8200,794	0,00
780.0	210,444	8017,220	0,00	480.0	363,036	8203,231	0,00
790.0	212,680	8020,180	0,00	490.0	365,098	8205,663	0,00
800.0	214,918	8023,127	0,00	500.0	367,155	8208,090	0,00

## Угол входа — 2,0 град

Н, км	DVT, м/с	VBX, м/с	ТЕТА, ГРАД	Н, км	DVT, м/с	VBX, м/с	ТЕТА, ГРАД
110.0	1206.555	6645.630	79.98	810.0	219.433	8024.011	0.00
120.0	683.184	7175.126	80.91	820.0	221.645	8026.952	0.00
130.0	480.812	7383.549	77.75	830.0	223.859	8029.899	0.00
140.0	374.272	7496.111	72.19	840.0	226.074	8032.824	0.00
150.0	309.148	7557.237	64.55	850.0	228.291	8035.737	0.00
160.0	265.673	7616.695	54.66	860.0	230.509	8038.638	0.00
170.0	234.933	7653.403	41.60	870.0	232.727	8041.527	0.00
180.0	212.317	7681.972	20.92	880.0	234.946	8044.405	0.00
190.0	195.199	7705.029	0.00	890.0	237.165	8047.271	0.00
200.0	181.974	7724.179	0.00	900.0	239.385	8050.127	0.00
210.0	171.606	7740.457	0.00	910.0	241.604	8052.972	0.00
220.0	163.395	7754.565	0.00	920.0	243.823	8055.807	0.00
230.0	156.853	7766.990	0.00	930.0	246.041	8058.632	0.00
240.0	151.628	7778.084	0.00	940.0	248.259	8061.446	0.00
250.0	147.461	7788.108	0.00	950.0	250.475	8064.251	0.00
260.0	144.154	7797.257	0.00	960.0	252.691	8067.047	0.00
270.0	141.558	7805.682	0.00	970.0	254.906	8069.832	0.00
280.0	139.554	7813.501	0.00	980.0	257.119	8072.609	0.00
290.0	138.050	7820.808	0.00	990.0	259.331	8075.377	0.00
300.0	136.970	7827.677	0.00	1000.0	261.541	8078.136	0.00
310.0	136.254	7834.169	0.00	1010.0	263.749	8080.885	0.00
320.0	135.852	7840.335	0.00	1020.0	265.956	8083.627	0.00
330.0	135.721	7846.215	0.00	1030.0	268.161	8086.360	0.00
340.0	135.829	7851.844	0.00	1040.0	270.363	8089.085	0.00
350.0	136.145	7857.252	0.00	1050.0	272.564	8091.802	0.00
360.0	136.646	7862.463	0.00	1060.0	274.762	8094.510	0.00
370.0	137.309	7867.497	0.00	1070.0	276.958	8097.211	0.00
380.0	138.118	7872.374	0.00	1080.0	279.151	8099.904	0.00
390.0	139.056	7877.109	0.00	1090.0	281.342	8102.589	0.00
400.0	140.110	7881.715	0.00	1100.0	283.531	8105.267	0.00
410.0	141.268	7886.205	0.00	1110.0	285.717	8107.937	0.00
420.0	142.519	7890.587	0.00	1120.0	287.900	8110.600	0.00
430.0	143.856	7894.873	0.00	1130.0	290.080	8113.255	0.00
440.0	145.269	7899.069	0.00	1140.0	292.257	8115.904	0.00
450.0	146.752	7903.184	0.00	1150.0	294.432	8118.545	0.00
460.0	148.298	7907.222	0.00	1160.0	296.603	8121.179	0.00
470.0	149.902	7911.191	0.00	1170.0	298.772	8123.807	0.00
480.0	151.558	7915.094	0.00	1180.0	300.937	8126.428	0.00
490.0	153.262	7918.937	0.00	1190.0	303.099	8129.041	0.00
500.0	155.011	7922.724	0.00	1200.0	305.259	8131.649	0.00
510.0	156.799	7926.458	0.00	1210.0	307.414	8134.249	0.00
520.0	158.625	7930.143	0.00	1220.0	309.567	8136.843	0.00
530.0	160.484	7933.782	0.00	1230.0	311.716	8139.431	0.00
540.0	162.375	7937.378	0.00	1240.0	313.862	8142.012	0.00
550.0	164.294	7940.933	0.00	1250.0	316.005	8144.587	0.00
560.0	166.240	7944.450	0.00	1260.0	318.144	8147.156	0.00
570.0	168.210	7947.930	0.00	1270.0	320.280	8149.719	0.00
580.0	170.203	7951.376	0.00	1280.0	322.412	8152.275	0.00
590.0	172.216	7954.789	0.00	1290.0	324.540	8154.826	0.00
600.0	174.248	7958.171	0.00	1300.0	326.666	8157.370	0.00
610.0	176.298	7961.524	0.00	1310.0	328.787	8159.908	0.00
620.0	178.364	7964.849	0.00	1320.0	330.905	8162.441	0.00
630.0	180.444	7968.148	0.00	1330.0	333.019	8164.968	0.00
640.0	182.539	7971.421	0.00	1340.0	335.130	8167.489	0.00
650.0	184.646	7974.669	0.00	1350.0	337.237	8170.004	0.00
660.0	186.765	7977.894	0.00	1360.0	339.341	8172.513	0.00
670.0	188.894	7981.097	0.00	1370.0	341.440	8175.017	0.00
680.0	191.033	7984.279	0.00	1380.0	343.536	8177.516	0.00
690.0	193.182	7987.440	0.00	1390.0	345.628	8180.008	0.00
700.0	195.338	7990.581	0.00	1400.0	347.717	8182.496	0.00
710.0	197.502	7993.703	0.00	1410.0	349.801	8184.978	0.00
720.0	199.673	7996.807	0.00	1420.0	351.882	8187.454	0.00
730.0	201.851	7999.893	0.00	1430.0	353.959	8189.925	0.00
740.0	204.034	8002.962	0.00	1440.0	356.032	8192.391	0.00
750.0	206.222	8006.014	0.00	1450.0	358.101	8194.851	0.00
760.0	208.415	8009.051	0.00	1460.0	360.167	8197.305	0.00
770.0	210.612	8012.072	0.00	1470.0	362.228	8199.756	0.00
780.0	212.812	8015.078	0.00	1480.0	364.285	8202.201	0.00
790.0	215.017	8018.070	0.00	1490.0	366.340	8204.640	0.00
800.0	217.224	8021.047	0.00	1500.0	368.390	8207.075	0.00



## Угол входа — 2.1 град

Н, км	DVT, м/с	VBX, м/с	ТЕТА, ГРАД	Н, км	DVT, м/с	VBX, м/с	ТЕТА, ГРАД
110.0	1300.980	6551.413	79.36	810.0	221.824	8021.858	0.00
120.0	743.134	7115.398	80.80	820.0	224.005	8024.839	0.00
130.0	524.525	7340.035	78.16	830.0	226.189	8027.803	0.00
140.0	408.648	7461.968	73.23	840.0	228.376	8030.760	0.00
150.0	337.475	7539.144	66.38	850.0	230.554	8033.701	0.00
160.0	289.766	7592.839	57.57	860.0	232.734	8036.629	0.00
170.0	255.898	7632.676	46.24	870.0	234.946	8039.545	0.00
180.0	230.876	7663.651	30.28	880.0	237.139	8042.449	0.00
190.0	211.852	7688.615	0.00	890.0	239.333	8045.341	0.00
200.0	197.078	7709.314	0.00	900.0	241.527	8048.221	0.00
210.0	185.427	7726.876	0.00	910.0	243.722	8051.091	0.00
220.0	176.137	7742.063	0.00	920.0	245.918	8053.949	0.00
230.0	168.674	7755.409	0.00	930.0	248.113	8056.796	0.00
240.0	162.653	7767.299	0.00	940.0	250.308	8059.633	0.00
250.0	157.792	7778.017	0.00	950.0	252.503	8062.460	0.00
260.0	153.875	7787.776	0.00	960.0	254.697	8065.277	0.00
270.0	150.737	7796.743	0.00	970.0	256.890	8068.084	0.00
280.0	148.251	7805.045	0.00	980.0	259.083	8070.881	0.00
290.0	146.313	7812.786	0.00	990.0	261.275	8073.669	0.00
300.0	144.841	7820.047	0.00	1000.0	263.465	8076.447	0.00
310.0	143.769	7826.895	0.00	1010.0	265.655	8079.216	0.00
320.0	143.042	7833.384	0.00	1020.0	267.842	8081.976	0.00
330.0	142.616	7839.561	0.00	1030.0	270.029	8084.728	0.00
340.0	142.450	7845.463	0.00	1040.0	272.213	8087.470	0.00
350.0	142.515	7851.122	0.00	1050.0	274.396	8090.205	0.00
360.0	142.783	7856.566	0.00	1060.0	276.577	8092.930	0.00
370.0	143.231	7861.816	0.00	1070.0	278.756	8095.648	0.00
380.0	143.839	7866.894	0.00	1080.0	280.933	8098.357	0.00
390.0	144.590	7871.816	0.00	1090.0	283.108	8101.059	0.00
400.0	145.469	7876.597	0.00	1100.0	285.280	8103.752	0.00
410.0	146.463	7881.250	0.00	1110.0	287.451	8106.438	0.00
420.0	147.561	7885.786	0.00	1120.0	289.618	8109.116	0.00
430.0	148.753	7890.216	0.00	1130.0	291.784	8111.786	0.00
440.0	150.030	7894.549	0.00	1140.0	293.946	8114.449	0.00
450.0	151.384	7898.792	0.00	1150.0	296.106	8117.105	0.00
460.0	152.808	7902.952	0.00	1160.0	298.264	8119.753	0.00
470.0	154.297	7907.036	0.00	1170.0	300.418	8122.395	0.00
480.0	155.844	7911.048	0.00	1180.0	302.570	8125.029	0.00
490.0	157.445	7914.995	0.00	1190.0	304.719	8127.656	0.00
500.0	159.094	7918.880	0.00	1200.0	306.865	8130.276	0.00
510.0	160.789	7922.709	0.00	1210.0	309.008	8132.890	0.00
520.0	162.525	7926.483	0.00	1220.0	311.148	8135.497	0.00
530.0	164.299	7930.208	0.00	1230.0	313.284	8138.097	0.00
540.0	166.108	7933.885	0.00	1240.0	315.418	8140.690	0.00
550.0	167.950	7937.518	0.00	1250.0	317.549	8143.277	0.00
560.0	169.821	7941.109	0.00	1260.0	319.676	8145.858	0.00
570.0	171.719	7944.660	0.00	1270.0	321.800	8148.432	0.00
580.0	173.643	7948.175	0.00	1280.0	323.921	8151.000	0.00
590.0	175.590	7951.654	0.00	1290.0	326.038	8153.561	0.00
600.0	177.559	7955.099	0.00	1300.0	328.152	8156.117	0.00
610.0	179.548	7958.513	0.00	1310.0	330.263	8158.666	0.00
620.0	181.556	7961.896	0.00	1320.0	332.370	8161.209	0.00
630.0	183.580	7965.251	0.00	1330.0	334.474	8163.745	0.00
640.0	185.620	7968.578	0.00	1340.0	336.574	8166.278	0.00
650.0	187.675	7971.879	0.00	1350.0	338.671	8168.803	0.00
660.0	189.743	7975.154	0.00	1360.0	340.764	8171.322	0.00
670.0	191.824	7978.406	0.00	1370.0	342.854	8173.836	0.00
680.0	193.916	7981.634	0.00	1380.0	344.940	8176.344	0.00
690.0	196.019	7984.841	0.00	1390.0	347.022	8178.846	0.00
700.0	198.132	7988.026	0.00	1400.0	349.101	8181.343	0.00
710.0	200.253	7991.190	0.00	1410.0	351.177	8183.834	0.00
720.0	202.383	7994.335	0.00	1420.0	353.248	8186.320	0.00
730.0	204.520	7997.461	0.00	1430.0	355.316	8188.800	0.00
740.0	206.665	8000.569	0.00	1440.0	357.380	8191.274	0.00
750.0	208.815	8003.659	0.00	1450.0	359.441	8193.743	0.00
760.0	210.972	8006.731	0.00	1460.0	361.498	8196.207	0.00
770.0	213.134	8009.788	0.00	1470.0	363.551	8198.665	0.00
780.0	215.300	8012.828	0.00	1480.0	365.600	8201.118	0.00
79.00	217.471	8015.853	0.00	1490.0	367.646	8203.566	0.00
80.00	219.646	8018.863	0.00	1500.0	369.688	8206.009	0.00

## Угол входа — 2,2 град

Н, км	DVT, м/с	VВХ, м/с	ТЕТА, ГРАД	Н, км	DVT, м/с	VВХ, м/с	ТЕТА, ГРАД
110.0	1395.816	6456.789	78.73	810.0	224.329	8019.602	0.00
120.0	801.427	7054.337	80.63	820.0	226.478	8022.615	0.00
130.0	569.550	7295.280	78.46	830.0	228.631	8025.613	0.00
140.0	444.200	7426.658	74.09	840.0	230.787	8028.597	0.00
150.0	366.847	7510.018	67.93	850.0	232.946	8031.558	0.00
160.0	314.792	7568.060	60.02	860.0	235.108	8034.524	0.00
170.0	277.702	7611.120	50.00	870.0	237.271	8037.458	0.00
180.0	250.198	7644.579	36.71	880.0	239.437	8040.399	0.00
190.0	229.202	7671.515	13.16	890.0	241.604	8043.318	0.00
200.0	212.825	7693.817	0.00	900.0	243.773	8046.224	0.00
210.0	199.845	7712.709	0.00	910.0	245.942	8049.119	0.00
220.0	189.434	7729.017	0.00	920.0	248.113	8052.001	0.00
230.0	181.014	7743.321	0.00	930.0	250.284	8054.873	0.00
240.0	174.166	7756.038	0.00	940.0	252.456	8057.734	0.00
250.0	168.584	7767.477	0.00	950.0	254.627	8060.583	0.00
260.0	164.031	7777.871	0.00	960.0	256.799	8063.422	0.00
270.0	160.331	7787.401	0.00	970.0	258.971	8066.251	0.00
280.0	157.341	7796.207	0.00	980.0	261.142	8069.070	0.00
290.0	154.951	7804.400	0.00	990.0	263.313	8071.878	0.00
300.0	153.071	7812.069	0.00	1000.0	265.483	8074.677	0.00
310.0	151.628	7819.288	0.00	010.0	267.652	8077.466	0.00
320.0	150.564	7826.115	0.00	020.0	269.820	8080.246	0.00
330.0	149.827	7832.602	0.00	030.0	271.987	8083.017	0.00
340.0	149.378	7838.788	0.00	040.0	274.153	8085.778	0.00
350.0	149.180	7844.710	0.00	050.0	276.317	8088.531	0.00
360.0	149.205	7850.396	0.00	060.0	278.480	8091.274	0.00
370.0	149.428	7855.871	0.00	070.0	280.641	8094.009	0.00
380.0	149.826	7861.158	0.00	080.0	282.801	8096.735	0.00
390.0	150.382	7866.276	0.00	090.0	284.959	8099.454	0.00
400.0	151.078	7871.239	0.00	100.0	287.114	8102.164	0.00
410.0	151.901	7876.063	0.00	110.0	289.268	8104.865	0.00
420.0	152.838	7880.761	0.00	120.0	291.420	8107.560	0.00
430.0	153.879	7885.342	0.00	130.0	293.569	8110.246	0.00
440.0	155.014	7889.817	0.00	140.0	295.717	8112.925	0.00
450.0	156.233	7894.194	0.00	150.0	297.862	8115.596	0.00
460.0	157.531	7898.481	0.00	160.0	300.004	8118.259	0.00
470.0	158.899	7902.685	0.00	170.0	302.144	8120.914	0.00
480.0	160.332	7906.812	0.00	180.0	304.282	8123.563	0.00
490.0	161.824	7910.867	0.00	190.0	306.416	8126.204	0.00
500.0	163.370	7914.855	0.00	200.0	308.548	8128.838	0.00
510.0	164.967	7918.782	0.00	210.0	310.678	8131.465	0.00
520.0	166.609	7922.650	0.00	220.0	312.804	8134.085	0.00
530.0	168.294	7926.464	0.00	230.0	314.928	8136.698	0.00
540.0	170.018	7930.226	0.00	240.0	317.049	8139.304	0.00
550.0	171.778	7933.940	0.00	250.0	319.167	8141.901	0.00
560.0	173.571	7937.610	0.00	260.0	321.282	8144.497	0.00
570.0	175.395	7941.236	0.00	270.0	323.394	8147.083	0.00
580.0	177.247	7944.822	0.00	280.0	325.502	8149.663	0.00
590.0	179.125	7948.370	0.00	290.0	327.608	8152.236	0.00
600.0	181.028	7951.881	0.00	300.0	329.710	8154.803	0.00
610.0	182.953	7955.359	0.00	310.0	331.810	8157.363	0.00
620.0	184.900	7958.803	0.00	320.0	333.906	8159.918	0.00
630.0	186.865	7962.216	0.00	330.0	335.998	8162.466	0.00
640.0	188.849	7965.600	0.00	340.0	338.088	8165.008	0.00
650.0	190.849	7968.956	0.00	350.0	340.174	8167.544	0.00
660.0	192.864	7972.284	0.00	360.0	342.255	8170.074	0.00
670.0	194.894	7975.586	0.00	370.0	344.336	8172.598	0.00
680.0	196.937	7978.864	0.00	380.0	346.412	8175.116	0.00
690.0	198.992	7982.118	0.00	390.0	348.484	8177.628	0.00
700.0	201.059	7985.349	0.00	400.0	350.553	8180.135	0.00
710.0	203.136	7988.558	0.00	410.0	352.619	8182.635	0.00
720.0	205.222	7991.746	0.00	420.0	354.681	8185.130	0.00
730.0	207.318	7994.913	0.00	430.0	356.739	8187.620	0.00
740.0	209.422	7998.061	0.00	440.0	358.794	8190.104	0.00
750.0	211.533	8001.190	0.00	450.0	360.845	8192.582	0.00
760.0	213.652	8004.301	0.00	460.0	362.893	8195.054	0.00
770.0	215.776	8007.394	0.00	470.0	364.937	8197.522	0.00
780.0	217.907	8010.471	0.00	480.0	366.978	8199.983	0.00
790.0	220.043	8013.530	0.00	490.0	369.015	8202.440	0.00
800.0	222.184	8016.574	0.00	1500.0	371.048	8204.891	0.00

Угол входа — 2,3 град

H, мм	DVT, м/с	VBX, м/с	ТЕТА, ГРАД	H, мм	DVT, м/с	VBX, м/с	ТЕТА, ГРАД
110.0	1490.789	6362.035	78.09	810.0	226.949	8017.243	0.00
120.0	856.909	6992.095	80.42	820.0	229.064	8020.289	0.00
130.0	615.795	7249.282	78.67	830.0	231.185	8023.320	0.00
140.0	480.870	7390.242	74.79	840.0	233.309	8026.336	0.00
150.0	397.223	7479.898	69.24	850.0	235.437	8029.337	0.00
160.0	340.721	7542.389	62.09	860.0	237.569	8032.324	0.00
170.0	300.324	7588.757	53.14	870.0	239.703	8035.297	0.00
180.0	270.265	7624.772	41.66	880.0	241.840	8038.255	0.00
190.0	247.236	7653.742	24.88	890.0	243.979	8041.202	0.00
200.0	229.203	7677.701	0.00	900.0	246.121	8044.136	0.00
210.0	214.847	7697.968	0.00	910.0	248.264	8047.057	0.00
220.0	203.277	7715.436	0.00	920.0	250.409	8049.965	0.00
230.0	193.866	7730.731	0.00	930.0	252.555	8052.862	0.00
240.0	185.161	7744.305	0.00	940.0	254.702	8055.747	0.00
250.0	179.830	7756.493	0.00	950.0	256.849	8058.621	0.00
260.0	174.619	7767.547	0.00	960.0	258.997	8061.483	0.00
270.0	170.333	7777.682	0.00	970.0	261.145	8064.335	0.00
280.0	166.821	7786.991	0.00	980.0	263.295	8067.176	0.00
290.0	163.961	7795.653	0.00	990.0	265.443	8070.006	0.00
300.0	161.656	7803.747	0.00	1000.0	267.592	8072.826	0.00
310.0	159.828	7811.351	0.00	1010.0	269.740	8075.636	0.00
320.0	158.412	7818.531	0.00	1020.0	271.888	8078.437	0.00
330.0	157.353	7825.339	0.00	1030.0	274.035	8081.227	0.00
340.0	156.608	7831.822	0.00	1040.0	276.181	8084.008	0.00
350.0	156.137	7838.016	0.00	1050.0	278.326	8086.780	0.00
360.0	155.910	7843.955	0.00	1060.0	280.470	8089.543	0.00
370.0	155.898	7849.665	0.00	1070.0	282.613	8092.296	0.00
380.0	156.078	7855.170	0.00	1080.0	284.754	8095.041	0.00
390.0	156.430	7860.491	0.00	1090.0	286.894	8097.777	0.00
400.0	156.936	7865.645	0.00	1100.0	289.032	8100.504	0.00
410.0	157.581	7870.647	0.00	1110.0	291.169	8103.223	0.00
420.0	158.350	7875.512	0.00	1120.0	293.304	8105.934	0.00
430.0	159.234	7880.251	0.00	1130.0	295.437	8108.636	0.00
440.0	160.220	7884.874	0.00	1140.0	297.568	8111.331	0.00
450.0	161.299	7889.392	0.00	1150.0	299.698	8114.017	0.00
460.0	162.464	7893.811	0.00	1160.0	301.824	8116.696	0.00
470.0	163.705	7898.141	0.00	1170.0	303.949	8119.366	0.00
480.0	165.020	7902.387	0.00	1180.0	306.072	8122.030	0.00
490.0	166.399	7906.555	0.00	1190.0	308.192	8124.685	0.00
500.0	167.838	7910.651	0.00	1200.0	310.310	8127.334	0.00
510.0	169.333	7914.679	0.00	1210.0	312.425	8129.975	0.00
520.0	170.878	7918.645	0.00	1220.0	314.537	8132.609	0.00
530.0	172.469	7922.552	0.00	1230.0	316.647	8135.235	0.00
540.0	174.104	7926.403	0.00	1240.0	318.755	8137.855	0.00
550.0	175.779	7930.202	0.00	1250.0	320.859	8140.467	0.00
560.0	177.490	7933.953	0.00	1260.0	322.961	8143.073	0.00
570.0	179.236	7937.657	0.00	1270.0	325.060	8145.672	0.00
580.0	181.013	7941.318	0.00	1280.0	327.157	8148.264	0.00
590.0	182.820	7944.938	0.00	1290.0	329.250	8150.850	0.00
600.0	184.653	7948.518	0.00	1300.0	331.340	8153.429	0.00
610.0	186.512	7952.052	0.00	1310.0	333.427	8155.001	0.00
620.0	188.395	7955.570	0.00	1320.0	335.512	8156.567	0.00
630.0	190.299	7959.045	0.00	1330.0	337.593	8158.127	0.00
640.0	192.223	7962.488	0.00	1340.0	339.671	8159.680	0.00
650.0	194.166	7965.900	0.00	1350.0	341.746	8161.227	0.00
660.0	196.126	7969.284	0.00	1360.0	343.817	8162.768	0.00
670.0	198.103	7972.639	0.00	1370.0	345.886	8164.303	0.00
680.0	200.094	7975.968	0.00	1380.0	347.951	8165.832	0.00
690.0	202.100	7979.271	0.00	1390.0	350.013	8167.354	0.00
700.0	204.118	7982.550	0.00	1400.0	352.072	8168.871	0.00
710.0	206.149	7985.805	0.00	1410.0	354.127	8170.382	0.00
720.0	208.191	7989.039	0.00	1420.0	356.179	8171.887	0.00
730.0	210.243	7992.250	0.00	1430.0	358.227	8173.386	0.00
740.0	212.304	7995.440	0.00	1440.0	360.273	8174.879	0.00
750.0	214.375	7998.610	0.00	1450.0	362.314	8176.367	0.00
760.0	216.453	8001.761	0.00	1460.0	364.353	8177.849	0.00
770.0	218.539	8004.892	0.00	1470.0	366.387	8179.325	0.00
780.0	220.633	8008.005	0.00	1480.0	368.419	8180.796	0.00
790.0	222.732	8011.102	0.00	1490.0	370.447	8201.262	0.00
800.0	224.838	8014.181	0.00	1500.0	372.471	8203.722	0.00

## Угол входа — 2,4 град

Н, мм	DVT, м/с	VВХ, м/с	ТЕТА, ГРАД	Н, мм	DVT, м/с	VВХ, м/с	ТЕТА, ГРАД
110.0	1585.649	6267.402	77.43	810.0	229.682	8014.782	0.00
120.0	930.432	6028.820	80.17	820.0	231.763	8017.853	0.00
130.0	663.175	7202.162	78.81	830.0	233.849	8020.928	0.00
140.0	518.599	7352.776	75.37	840.0	235.941	8023.976	0.00
150.0	428.561	7448.826	70.35	850.0	238.037	8027.009	0.00
160.0	367.521	7515.856	63.86	860.0	240.137	8030.027	0.00
170.0	323.739	7565.612	55.79	870.0	242.241	8033.031	0.00
180.0	291.057	7604.251	45.66	880.0	244.348	8036.020	0.00
190.0	265.937	7635.312	32.00	890.0	245.458	8038.995	0.00
200.0	246.199	7660.978	0.00	900.0	248.571	8041.956	0.00
210.0	230.425	7682.663	0.00	910.0	250.687	8044.905	0.00
220.0	217.658	7701.329	0.00	920.0	252.805	8047.840	0.00
230.0	207.222	7717.649	0.00	930.0	254.924	8050.763	0.00
240.0	198.631	7732.110	0.00	940.0	257.045	8053.674	0.00
250.0	191.525	7745.072	0.00	950.0	259.168	8056.573	0.00
260.0	185.632	7756.809	0.00	960.0	261.292	8059.459	0.00
270.0	180.740	7767.530	0.00	970.0	263.416	8062.335	0.00
280.0	176.686	7777.400	0.00	980.0	265.542	8065.199	0.00
290.0	173.339	7786.550	0.00	990.0	267.668	8068.052	0.00
300.0	170.594	7795.084	0.00	1000.0	269.794	8070.895	0.00
310.0	168.366	7803.089	0.00	1010.0	271.920	8073.727	0.00
320.0	166.585	7810.633	0.00	1020.0	274.046	8076.548	0.00
330.0	165.192	7817.776	0.00	1030.0	276.172	8079.360	0.00
340.0	164.139	7824.586	0.00	1040.0	278.297	8082.161	0.00
350.0	163.384	7831.044	0.00	1050.0	280.422	8084.953	0.00
360.0	162.894	7837.246	0.00	1060.0	282.547	8087.735	0.00
370.0	162.639	7843.199	0.00	1070.0	284.670	8090.508	0.00
380.0	162.592	7848.931	0.00	1080.0	286.793	8093.271	0.00
390.0	162.733	7854.464	0.00	1090.0	288.914	8096.026	0.00
400.0	163.041	7859.815	0.00	1100.0	291.034	8098.771	0.00
410.0	163.500	7865.003	0.00	1110.0	293.153	8101.508	0.00
420.0	164.096	7870.042	0.00	1120.0	295.271	8104.236	0.00
430.0	164.815	7874.945	0.00	1130.0	297.387	8106.955	0.00
440.0	165.646	7879.722	0.00	1140.0	299.501	8109.667	0.00
450.0	166.580	7884.385	0.00	1150.0	301.614	8112.369	0.00
460.0	167.607	7888.943	0.00	1160.0	303.725	8115.064	0.00
470.0	168.719	7893.403	0.00	1170.0	305.833	8117.751	0.00
480.0	169.909	7897.773	0.00	1180.0	307.940	8120.430	0.00
490.0	171.170	7902.059	0.00	1190.0	310.045	8123.100	0.00
500.0	172.497	7906.266	0.00	1200.0	312.148	8125.764	0.00
510.0	173.885	7910.402	0.00	1210.0	314.248	8128.419	0.00
520.0	175.328	7914.469	0.00	1220.0	316.346	8131.068	0.00
530.0	176.823	7918.472	0.00	1230.0	318.442	8133.708	0.00
540.0	178.365	7922.416	0.00	1240.0	320.535	8136.342	0.00
550.0	179.951	7926.304	0.00	1250.0	322.626	8138.968	0.00
560.0	181.578	7930.140	0.00	1260.0	324.715	8141.587	0.00
570.0	183.242	7933.925	0.00	1270.0	326.800	8144.200	0.00
580.0	184.941	7937.664	0.00	1280.0	328.883	8146.805	0.00
590.0	186.673	7941.358	0.00	1290.0	330.964	8149.403	0.00
600.0	188.435	7945.011	0.00	1300.0	333.041	8151.995	0.00
610.0	190.225	7948.623	0.00	1310.0	335.116	8154.579	0.00
620.0	192.041	7952.198	0.00	1320.0	337.188	8157.158	0.00
630.0	193.881	7955.737	0.00	1330.0	339.257	8159.729	0.00
640.0	195.743	7959.241	0.00	1340.0	341.324	8162.294	0.00
650.0	197.626	7962.713	0.00	1350.0	343.387	8164.853	0.00
660.0	199.529	7966.154	0.00	1360.0	345.447	8167.405	0.00
670.0	201.451	7969.565	0.00	1370.0	347.504	8169.951	0.00
680.0	203.389	7972.947	0.00	1380.0	349.558	8172.491	0.00
690.0	205.342	7976.302	0.00	1390.0	351.609	8175.024	0.00
700.0	207.311	7979.631	0.00	1400.0	353.657	8177.552	0.00
710.0	209.293	7982.935	0.00	1410.0	355.702	8180.073	0.00
720.0	211.288	7986.215	0.00	1420.0	357.743	8182.588	0.00
730.0	213.294	7989.471	0.00	1430.0	359.781	8185.098	0.00
740.0	215.312	7992.705	0.00	1440.0	361.816	8187.601	0.00
750.0	217.339	7995.918	0.00	1450.0	363.848	8190.099	0.00
760.0	219.377	7999.110	0.00	1460.0	365.876	8192.591	0.00
770.0	221.422	8002.282	0.00	1470.0	367.901	8195.077	0.00
780.0	223.477	8005.434	0.00	1480.0	369.923	8197.557	0.00
790.0	225.538	8008.568	0.00	1490.0	371.941	8200.032	0.00
800.0	227.607	8011.684	0.00	1500.0	373.956	8202.501	0.00

## Угол входа — 2,5 град

Н, км	DVT, м/с	VBX, м/с	ТЕТА, ГРАД	Н, км	DVT, м/с	VBX, м/с	ТЕТА, ГРАД
110.0	1680.171	6173.112	76.78	810.0	232.529	8012.218	0.00
120.0	934.855	6864.655	79.88	820.0	234.573	8015.336	0.00
130.0	711.598	7154.006	78.88	830.0	236.624	8018.436	0.00
140.0	557.328	7314.320	75.85	840.0	238.682	8021.518	0.00
150.0	460.819	7416.844	71.29	850.0	240.744	8024.585	0.00
160.0	395.163	7488.494	65.38	860.0	242.811	8027.635	0.00
170.0	347.923	7541.708	58.05	870.0	244.884	8030.670	0.00
180.0	312.556	7583.033	49.00	880.0	246.960	8033.690	0.00
190.0	285.291	7616.241	37.32	890.0	249.040	8036.696	0.00
200.0	263.799	7643.660	19.12	900.0	251.124	8039.687	0.00
210.0	246.567	7666.805	0.00	910.0	253.211	8042.664	0.00
220.0	232.566	7686.705	0.00	920.0	255.300	8045.627	0.00
230.0	221.074	7704.081	0.00	930.0	257.393	8048.577	0.00
240.0	211.569	7719.457	0.00	940.0	259.487	8051.514	0.00
250.0	203.663	7733.220	0.00	950.0	261.584	8054.439	0.00
260.0	197.064	7745.662	0.00	960.0	263.682	8057.351	0.00
270.0	191.546	7757.010	0.00	970.0	265.781	8060.252	0.00
280.0	186.932	7767.440	0.00	980.0	267.882	8063.140	0.00
290.0	183.081	7777.094	0.00	990.0	269.984	8066.017	0.00
300.0	179.880	7786.084	0.00	1000.0	272.087	8068.883	0.00
310.0	177.238	7794.503	0.00	1010.0	274.191	8071.737	0.00
320.0	175.078	7802.426	0.00	1020.0	276.294	8074.581	0.00
330.0	173.339	7809.915	0.00	1030.0	278.399	8077.414	0.00
340.0	171.967	7817.024	0.00	1040.0	280.503	8080.237	0.00
350.0	170.919	7823.796	0.00	1050.0	282.607	8083.050	0.00
360.0	170.157	7830.270	0.00	1060.0	284.711	8085.852	0.00
370.0	169.649	7836.476	0.00	1070.0	286.814	8088.645	0.00
380.0	169.367	7842.443	0.00	1080.0	288.917	8091.428	0.00
390.0	169.288	7848.195	0.00	1090.0	291.019	8094.202	0.00
400.0	169.391	7853.752	0.00	1100.0	293.120	8096.966	0.00
410.0	169.657	7859.132	0.00	1110.0	295.221	8099.721	0.00
420.0	170.072	7864.352	0.00	1120.0	297.320	8102.467	0.00
430.0	170.622	7869.424	0.00	1130.0	299.418	8105.204	0.00
440.0	171.293	7874.363	0.00	1140.0	301.515	8107.933	0.00
450.0	172.075	7879.177	0.00	1150.0	303.610	8110.653	0.00
460.0	172.959	7883.878	0.00	1160.0	305.704	8113.364	0.00
470.0	173.935	7888.473	0.00	1170.0	307.797	8116.067	0.00
480.0	174.996	7892.972	0.00	1180.0	309.887	8118.762	0.00
490.0	176.135	7897.380	0.00	1190.0	311.976	8121.449	0.00
500.0	177.346	7901.704	0.00	1200.0	314.063	8124.128	0.00
510.0	178.623	7905.950	0.00	1210.0	316.148	8126.799	0.00
520.0	179.961	7910.122	0.00	1220.0	318.231	8129.462	0.00
530.0	181.355	7914.227	0.00	1230.0	320.312	8132.118	0.00
540.0	182.800	7918.267	0.00	1240.0	322.391	8134.766	0.00
550.0	184.294	7922.247	0.00	1250.0	324.467	8137.406	0.00
560.0	185.833	7926.170	0.00	1260.0	326.542	8140.039	0.00
570.0	187.413	7930.040	0.00	1270.0	328.613	8142.665	0.00
580.0	189.031	7933.860	0.00	1280.0	330.683	8145.284	0.00
590.0	190.685	7937.632	0.00	1290.0	332.750	8147.896	0.00
600.0	192.372	7941.359	0.00	1300.0	334.814	8150.500	0.00
610.0	194.090	7945.043	0.00	1310.0	336.876	8153.098	0.00
620.0	195.837	7948.687	0.00	1320.0	338.935	8155.689	0.00
630.0	197.610	7952.293	0.00	1330.0	340.992	8158.273	0.00
640.0	199.408	7955.861	0.00	1340.0	343.046	8160.850	0.00
650.0	201.230	7959.395	0.00	1350.0	345.097	8163.421	0.00
660.0	203.073	7962.895	0.00	1360.0	347.145	8165.985	0.00
670.0	204.937	7966.364	0.00	1370.0	349.190	8168.543	0.00
680.0	206.819	7969.802	0.00	1380.0	351.233	8171.094	0.00
690.0	208.719	7973.210	0.00	1390.0	353.272	8173.639	0.00
700.0	210.635	7976.591	0.00	1400.0	355.309	8176.177	0.00
710.0	212.567	7979.946	0.00	1410.0	357.342	8178.710	0.00
720.0	214.513	7983.274	0.00	1420.0	359.373	8181.236	0.00
730.0	216.472	7986.578	0.00	1430.0	361.400	8183.756	0.00
740.0	218.444	7989.858	0.00	1440.0	363.425	8186.270	0.00
750.0	220.427	7993.115	0.00	1450.0	365.446	8188.778	0.00
760.0	222.421	7996.349	0.00	1460.0	367.464	8191.280	0.00
770.0	224.425	7999.563	0.00	1470.0	369.479	8193.776	0.00
780.0	226.439	8002.756	0.00	1480.0	371.491	8196.266	0.00
790.0	228.461	8005.929	0.00	1490.0	373.499	8198.751	0.00
800.0	230.491	8009.083	0.00	1500.0	375.504	8201.229	0.00



## Угол входа — 2.6 град

Н, км	DVT, м/с	VBX, м/с	ТЕТА, ГРАД	Н, км	DVT, м/с	VBX, м/с	ТЕТА, ГРАД
110.0	1774.154	6079.366	76.11	810.0	235.489	8009.553	0.00
120.0	1060.041	6799.734	79.57	820.0	237.496	8012.708	0.00
130.0	760.978	7104.902	78.90	830.0	239.510	8015.845	0.00
140.0	596.998	7274.933	76.23	840.0	241.532	8018.963	0.00
150.0	493.957	7383.993	72.10	850.0	243.569	8022.064	0.00
160.0	423.614	7460.332	66.69	860.0	245.593	8025.149	0.00
170.0	372.852	7517.071	60.00	870.0	247.632	8028.216	0.00
180.0	334.742	7561.140	51.82	880.0	249.676	8031.268	0.00
190.0	305.281	7596.545	41.57	890.0	251.725	8034.305	0.00
200.0	281.992	7625.762	27.33	900.0	253.778	8037.326	0.00
210.0	263.262	7650.406	0.00	910.0	255.835	8040.333	0.00
220.0	247.993	7671.574	0.00	920.0	257.896	8043.326	0.00
230.0	235.414	7690.037	0.00	930.0	259.960	8046.304	0.00
240.0	224.967	7706.355	0.00	940.0	262.026	8049.269	0.00
250.0	216.237	7720.942	0.00	950.0	264.096	8052.221	0.00
260.0	208.911	7734.112	0.00	960.0	266.167	8055.159	0.00
270.0	202.747	7746.106	0.00	970.0	268.241	8058.085	0.00
280.0	197.554	7757.116	0.00	980.0	270.317	8060.999	0.00
290.0	193.183	7767.290	0.00	990.0	272.394	8063.901	0.00
300.0	189.511	7776.751	0.00	1000.0	274.473	8066.791	0.00
310.0	186.441	7785.598	0.00	1010.0	276.552	8069.669	0.00
320.0	183.890	7793.912	0.00	1020.0	278.633	8072.536	0.00
330.0	181.793	7801.759	0.00	1030.0	280.714	8075.391	0.00
340.0	180.092	7809.198	0.00	1040.0	282.796	8078.236	0.00
350.0	178.739	7816.274	0.00	1050.0	284.879	8081.071	0.00
360.0	177.695	7823.029	0.00	1060.0	286.961	8083.894	0.00
370.0	176.925	7829.497	0.00	1070.0	289.044	8086.708	0.00
380.0	176.400	7835.708	0.00	1080.0	291.126	8089.511	0.00
390.0	176.094	7841.687	0.00	1090.0	293.208	8092.305	0.00
400.0	175.984	7847.457	0.00	1100.0	295.290	8095.089	0.00
410.0	176.051	7853.036	0.00	1110.0	297.371	8097.863	0.00
420.0	176.279	7858.443	0.00	1120.0	299.451	8100.628	0.00
430.0	176.652	7863.692	0.00	1130.0	301.531	8103.383	0.00
440.0	177.157	7868.796	0.00	1140.0	303.609	8106.130	0.00
450.0	177.783	7873.768	0.00	1150.0	305.687	8108.868	0.00
460.0	178.518	7878.617	0.00	1160.0	307.763	8111.597	0.00
470.0	179.353	7883.353	0.00	1170.0	309.838	8114.317	0.00
480.0	180.281	7887.985	0.00	1180.0	311.912	8117.028	0.00
490.0	181.294	7892.519	0.00	1190.0	313.984	8119.732	0.00
500.0	182.384	7896.964	0.00	1200.0	316.055	8122.427	0.00
510.0	183.546	7901.324	0.00	1210.0	318.124	8125.114	0.00
520.0	184.774	7905.606	0.00	1220.0	320.191	8127.792	0.00
530.0	186.063	7909.815	0.00	1230.0	322.257	8130.463	0.00
540.0	187.409	7913.955	0.00	1240.0	324.321	8133.126	0.00
550.0	188.808	7918.031	0.00	1250.0	326.382	8135.782	0.00
560.0	190.255	7922.046	0.00	1260.0	328.442	8138.429	0.00
570.0	191.747	7926.003	0.00	1270.0	330.499	8141.070	0.00
580.0	193.281	7929.907	0.00	1280.0	332.554	8143.702	0.00
590.0	194.854	7933.760	0.00	1290.0	334.608	8146.328	0.00
600.0	196.464	7937.564	0.00	1300.0	336.668	8148.946	0.00
610.0	198.107	7941.323	0.00	1310.0	338.707	8151.557	0.00
620.0	199.782	7945.038	0.00	1320.0	340.753	8154.161	0.00
630.0	201.486	7948.713	0.00	1330.0	342.796	8156.758	0.00
640.0	203.218	7952.348	0.00	1340.0	344.837	8159.348	0.00
650.0	204.975	7955.946	0.00	1350.0	346.875	8161.931	0.00
660.0	206.757	7959.508	0.00	1360.0	348.911	8164.508	0.00
670.0	208.560	7963.036	0.00	1370.0	350.944	8167.078	0.00
680.0	210.385	7966.532	0.00	1380.0	352.975	8169.641	0.00
690.0	212.229	7969.997	0.00	1390.0	355.002	8172.197	0.00
700.0	214.091	7973.432	0.00	1400.0	357.027	8174.747	0.00
710.0	215.970	7976.838	0.00	1410.0	359.049	8177.291	0.00
720.0	217.866	7980.217	0.00	1420.0	361.068	8179.829	0.00
730.0	219.776	7983.570	0.00	1430.0	363.085	8182.360	0.00
740.0	221.700	7986.897	0.00	1440.0	365.098	8184.885	0.00
750.0	223.637	7990.200	0.00	1450.0	367.108	8187.403	0.00
760.0	225.586	7993.480	0.00	1460.0	369.116	8189.916	0.00
770.0	227.547	7996.737	0.00	1470.0	371.120	8192.423	0.00
780.0	229.518	7999.972	0.00	1480.0	373.121	8194.923	0.00
790.0	231.499	8003.186	0.00	1490.0	375.120	8197.418	0.00
800.0	233.490	8006.379	0.00	1500.0	377.115	8199.906	0.00

## Угол входа — 2,7 град

H, км	DVT, м/с	VBX, м/с	ТЕТА, ГРАД	H, км	DVT, м/с	VBX, м/с	ТЕТА, ГРАД
110.0	1867.422	5986.342	75.45	810.0	238.562	8006.787	0.00
120.0	1125.859	6734.189	79.24	820.0	240.530	8009.981	0.00
130.0	811.232	7054.933	78.87	830.0	242.506	8013.155	0.00
140.0	637.551	7234.671	76.53	840.0	244.490	8016.310	0.00
150.0	527.930	7350.316	72.78	850.0	246.482	8019.448	0.00
160.0	452.842	7431.402	67.83	860.0	248.481	8022.567	0.00
170.0	398.500	7491.724	61.69	870.0	250.486	8025.669	0.00
180.0	357.595	7538.590	54.25	880.0	252.495	8028.754	0.00
190.0	325.891	7576.239	45.09	890.0	254.513	8031.823	0.00
200.0	300.763	7607.296	33.11	900.0	256.534	8034.876	0.00
210.0	280.497	7633.476	12.11	910.0	258.560	8037.914	0.00
220.0	263.928	7655.945	0.00	920.0	260.590	8040.936	0.00
230.0	250.233	7675.525	0.00	930.0	262.625	8043.944	0.00
240.0	238.818	7692.812	0.00	940.0	264.663	8046.938	0.00
250.0	229.241	7708.247	0.00	950.0	266.704	8049.917	0.00
260.0	221.166	7722.165	0.00	960.0	268.748	8052.883	0.00
270.0	214.336	7734.825	0.00	970.0	270.795	8055.836	0.00
280.0	208.548	7746.430	0.00	980.0	272.844	8058.776	0.00
290.0	203.640	7757.142	0.00	990.0	274.896	8061.703	0.00
300.0	199.483	7767.088	0.00	1000.0	276.949	8064.618	0.00
310.0	195.971	7776.377	0.00	1010.0	279.005	8067.521	0.00
320.0	193.017	7785.094	0.00	1020.0	281.061	8070.412	0.00
330.0	190.550	7793.312	0.00	1030.0	283.119	8073.291	0.00
340.0	188.508	7801.090	0.00	1040.0	285.178	8076.159	0.00
350.0	186.842	7808.481	0.00	1050.0	287.238	8079.015	0.00
360.0	185.507	7815.527	0.00	1060.0	289.298	8081.861	0.00
370.0	184.467	7822.265	0.00	1070.0	291.359	8084.696	0.00
380.0	183.690	7828.728	0.00	1080.0	293.420	8087.521	0.00
390.0	183.149	7834.942	0.00	1090.0	295.481	8090.335	0.00
400.0	182.819	7840.931	0.00	1100.0	297.542	8093.139	0.00
410.0	182.680	7846.717	0.00	1110.0	299.604	8095.933	0.00
420.0	182.714	7852.317	0.00	1120.0	301.664	8098.718	0.00
430.0	182.905	7857.748	0.00	1130.0	303.725	8101.493	0.00
440.0	183.238	7863.024	0.00	1140.0	305.784	8104.258	0.00
450.0	183.701	7868.158	0.00	1150.0	307.843	8107.014	0.00
460.0	184.283	7873.161	0.00	1160.0	309.902	8109.761	0.00
470.0	184.973	7878.043	0.00	1170.0	311.959	8112.499	0.00
480.0	185.763	7882.812	0.00	1180.0	314.015	8115.228	0.00
490.0	186.644	7887.478	0.00	1190.0	316.070	8117.948	0.00
500.0	187.609	7892.047	0.00	1200.0	318.124	8120.660	0.00
510.0	188.652	7896.527	0.00	1210.0	320.176	8123.363	0.00
520.0	189.767	7900.922	0.00	1220.0	322.227	8126.058	0.00
530.0	190.948	7905.239	0.00	1230.0	324.277	8128.745	0.00
540.0	192.191	7909.483	0.00	1240.0	326.325	8131.424	0.00
550.0	193.491	7913.657	0.00	1250.0	328.371	8134.094	0.00
560.0	194.843	7917.766	0.00	1260.0	330.415	8136.757	0.00
570.0	196.244	7921.815	0.00	1270.0	332.458	8139.412	0.00
580.0	197.691	7925.805	0.00	1280.0	334.498	8142.060	0.00
590.0	199.181	7929.742	0.00	1290.0	336.537	8144.699	0.00
600.0	200.710	7933.627	0.00	1300.0	338.573	8147.332	0.00
610.0	202.276	7937.463	0.00	1310.0	340.608	8149.957	0.00
620.0	203.876	7941.252	0.00	1320.0	342.640	8152.574	0.00
630.0	205.509	7944.998	0.00	1330.0	344.670	8155.185	0.00
640.0	207.172	7948.702	0.00	1340.0	346.698	8157.788	0.00
650.0	208.863	7952.367	0.00	1350.0	348.723	8160.384	0.00
660.0	210.580	7955.993	0.00	1360.0	350.746	8162.974	0.00
670.0	212.321	7959.583	0.00	1370.0	352.766	8165.556	0.00
680.0	214.086	7963.139	0.00	1380.0	354.784	8168.132	0.00
690.0	215.872	7966.661	0.00	1390.0	356.799	8170.700	0.00
700.0	217.678	7970.152	0.00	1400.0	358.812	8173.263	0.00
710.0	219.503	7973.613	0.00	1410.0	360.822	8175.818	0.00
720.0	221.346	7977.044	0.00	1420.0	362.829	8178.367	0.00
730.0	223.205	7980.448	0.00	1430.0	364.834	8180.910	0.00
740.0	225.080	7983.824	0.00	1440.0	366.836	8183.446	0.00
750.0	226.969	7987.175	0.00	1450.0	368.835	8185.976	0.00
760.0	228.872	7990.501	0.00	1460.0	370.831	8188.500	0.00
770.0	230.788	7993.803	0.00	1470.0	372.825	8191.017	0.00
780.0	232.715	7997.082	0.00	1480.0	374.815	8193.528	0.00
790.0	234.654	8000.338	0.00	1490.0	376.803	8196.033	0.00
800.0	236.603	8003.573	0.00	1500.0	378.787	8198.532	0.00

## Угол входа — 2,8 град

Н, мм	DVT, м/с	VBX, м/с	ТЕТА, ГРАД	Н, мм	DVT, м/с	VBX, м/с	ТЕТА, ГРАД
110.0	1959.818	5894.194	74.79	810.0	241.747	8003.919	0.00
120.0	1192.185	6668.143	78.88	820.0	243.675	8007.154	0.00
130.0	862.275	7004.184	78.80	830.0	245.612	8010.367	0.00
140.0	678.929	7193.594	76.76	840.0	247.558	8013.561	0.00
150.0	562.697	7315.854	73.36	850.0	249.512	8016.735	0.00
160.0	482.816	7401.738	68.81	860.0	251.474	8019.891	0.00
170.0	424.843	7465.692	63.17	870.0	253.444	8023.028	0.00
180.0	381.095	7515.404	56.35	880.0	255.420	8026.148	0.00
190.0	347.104	7555.340	48.08	890.0	257.403	8029.250	0.00
200.0	320.098	7588.277	37.64	900.0	259.391	8032.336	0.00
210.0	298.263	7616.027	22.49	910.0	261.385	8035.405	0.00
220.0	280.362	7639.829	0.00	920.0	263.384	8038.459	0.00
230.0	265.523	7660.554	0.00	930.0	265.388	8041.497	0.00
240.0	253.115	7678.834	0.00	940.0	267.396	8044.521	0.00
250.0	242.667	7695.139	0.00	950.0	269.408	8047.529	0.00
260.0	233.824	7709.827	0.00	960.0	271.424	8050.524	0.00
270.0	226.309	7723.172	0.00	970.0	273.443	8053.504	0.00
280.0	219.908	7735.390	0.00	980.0	275.465	8056.471	0.00
290.0	214.448	7746.653	0.00	990.0	277.490	8059.425	0.00
300.0	209.791	7757.100	0.00	1000.0	279.518	8062.366	0.00
310.0	205.825	7766.844	0.00	1010.0	281.547	8065.294	0.00
320.0	202.456	7775.976	0.00	1020.0	283.579	8068.210	0.00
330.0	199.667	7784.575	0.00	1030.0	285.612	8071.113	0.00
340.0	197.215	7792.705	0.00	1040.0	287.647	8074.005	0.00
350.0	195.224	7800.419	0.00	1050.0	289.684	8076.885	0.00
360.0	193.589	7807.765	0.00	1060.0	291.721	8079.753	0.00
370.0	192.271	7814.783	0.00	1070.0	293.759	8082.611	0.00
380.0	191.234	7821.505	0.00	1080.0	295.799	8085.457	0.00
390.0	190.450	7827.961	0.00	1090.0	297.838	8088.293	0.00
400.0	189.894	7834.177	0.00	1100.0	299.878	8091.118	0.00
410.0	189.542	7840.176	0.00	1110.0	301.919	8093.933	0.00
420.0	189.376	7845.976	0.00	1120.0	303.959	8096.737	0.00
430.0	189.379	7851.595	0.00	1130.0	306.000	8099.532	0.00
440.0	189.535	7857.049	0.00	1140.0	308.040	8102.317	0.00
450.0	189.830	7862.350	0.00	1150.0	310.080	8105.092	0.00
460.0	190.253	7867.512	0.00	1160.0	312.119	8107.857	0.00
470.0	190.793	7872.544	0.00	1170.0	314.158	8110.614	0.00
480.0	191.440	7877.456	0.00	1180.0	316.196	8113.361	0.00
490.0	192.185	7882.258	0.00	1190.0	318.233	8116.099	0.00
500.0	193.022	7886.956	0.00	1200.0	320.269	8118.828	0.00
510.0	193.942	7891.558	0.00	1210.0	322.305	8121.548	0.00
520.0	194.939	7896.071	0.00	1220.0	324.339	8124.260	0.00
530.0	196.009	7900.499	0.00	1230.0	326.372	8126.963	0.00
540.0	197.144	7904.850	0.00	1240.0	328.403	8129.658	0.00
550.0	198.342	7909.126	0.00	1250.0	330.433	8132.345	0.00
560.0	199.596	7913.334	0.00	1260.0	332.462	8135.023	0.00
570.0	200.903	7917.476	0.00	1270.0	334.489	8137.694	0.00
580.0	202.260	7921.556	0.00	1280.0	336.514	8140.356	0.00
590.0	203.663	7925.579	0.00	1290.0	338.538	8143.011	0.00
600.0	205.109	7929.547	0.00	1300.0	340.560	8145.658	0.00
610.0	206.596	7933.463	0.00	1310.0	342.579	8148.297	0.00
620.0	208.119	7937.330	0.00	1320.0	344.597	8150.929	0.00
630.0	209.678	7941.149	0.00	1330.0	346.613	8153.553	0.00
640.0	211.269	7944.925	0.00	1340.0	348.627	8156.170	0.00
650.0	212.891	7948.658	0.00	1350.0	350.639	8158.780	0.00
660.0	214.541	7952.351	0.00	1360.0	352.648	8161.383	0.00
670.0	216.219	7956.005	0.00	1370.0	354.655	8163.978	0.00
680.0	217.921	7959.622	0.00	1380.0	356.660	8166.567	0.00
690.0	219.647	7963.205	0.00	1390.0	358.663	8169.148	0.00
700.0	221.396	7966.754	0.00	1400.0	360.663	8171.723	0.00
710.0	223.164	7970.270	0.00	1410.0	362.661	8174.291	0.00
720.0	224.953	7973.756	0.00	1420.0	364.656	8176.852	0.00
730.0	226.759	7977.212	0.00	1430.0	366.648	8179.406	0.00
740.0	228.583	7980.639	0.00	1440.0	368.638	8181.954	0.00
750.0	230.423	7984.040	0.00	1450.0	370.626	8184.496	0.00
760.0	232.278	7987.414	0.00	1460.0	372.611	8187.031	0.00
770.0	234.147	7990.762	0.00	1470.0	374.593	8189.559	0.00
780.0	236.029	7994.086	0.00	1480.0	376.572	8192.082	0.00
790.0	237.924	7997.386	0.00	1490.0	378.549	8194.598	0.00
800.0	239.830	8000.664	0.00	1500.0	380.522	8197.108	0.00

Угол входа — 2,9 град

Н, км	DVT, м/с	VBX, м/с	ТЕТА, ГРАД	Н, км	DVT, м/с	VBX, м/с	ТЕТА, ГРАД
110.0	2051.208	5803.058	74.13	810.0	245.045	8300.951	0.00
120.0	1258.904	6601.712	78.51	820.0	246.930	8004.227	0.00
130.0	914.028	6952.733	78.69	830.0	248.827	8007.481	0.00
140.0	721.076	7151.758	76.93	840.0	250.733	8310.714	0.00
150.0	598.217	7280.650	73.85	850.0	252.649	8013.927	0.00
160.0	513.504	7371.370	69.67	860.0	254.573	8017.120	0.00
170.0	451.856	7439.001	64.47	870.0	256.505	8020.294	0.00
180.0	405.221	7491.601	58.19	880.0	258.447	8023.449	0.00
190.0	368.904	7533.866	50.65	890.0	260.395	8026.585	0.00
200.0	339.984	7568.718	41.37	900.0	262.349	8029.706	0.00
210.0	316.546	7598.072	28.94	910.0	264.310	8032.809	0.00
220.0	297.283	7623.236	0.00	920.0	266.277	8035.895	0.00
230.0	281.274	7645.131	0.00	930.0	268.249	8038.964	0.00
240.0	267.849	7664.429	0.00	940.0	270.226	8042.019	0.00
250.0	256.509	7681.627	0.00	950.0	272.208	8045.057	0.00
260.0	246.877	7697.104	0.00	960.0	274.194	8048.081	0.00
270.0	238.661	7711.151	0.00	970.0	276.185	8051.090	0.00
280.0	231.630	7723.999	0.00	980.0	278.179	8054.085	0.00
290.0	225.603	7735.830	0.00	990.0	280.176	8057.066	0.00
300.0	220.433	7746.790	0.00	1000.0	282.177	8060.034	0.00
310.0	215.998	7757.002	0.00	1010.0	284.180	8062.988	0.00
320.0	212.202	7766.562	0.00	1020.0	286.186	8065.930	0.00
330.0	208.961	7775.553	0.00	1030.0	288.194	8068.858	0.00
340.0	206.208	7784.043	0.00	1040.0	290.204	8071.774	0.00
350.0	203.884	7792.092	0.00	1050.0	292.217	8074.678	0.00
360.0	201.940	7799.747	0.00	1060.0	294.230	8077.571	0.00
370.0	200.334	7807.051	0.00	1070.0	296.245	8080.451	0.00
380.0	199.030	7814.041	0.00	1080.0	298.262	8083.320	0.00
390.0	197.996	7820.747	0.00	1090.0	300.279	8086.178	0.00
400.0	197.206	7827.197	0.00	1100.0	302.298	8089.025	0.00
410.0	196.636	7833.415	0.00	1110.0	304.316	8091.861	0.00
420.0	196.264	7839.421	0.00	1120.0	306.336	8094.686	0.00
430.0	196.072	7845.235	0.00	1130.0	308.356	8097.502	0.00
440.0	196.045	7850.871	0.00	1140.0	310.376	8100.306	0.00
450.0	196.167	7856.346	0.00	1150.0	312.395	8103.101	0.00
460.0	196.426	7861.671	0.00	1160.0	314.415	8105.886	0.00
470.0	196.811	7866.858	0.00	1170.0	316.435	8108.662	0.00
480.0	197.310	7871.917	0.00	1180.0	318.454	8111.427	0.00
490.0	197.916	7876.859	0.00	1190.0	320.473	8114.184	0.00
500.0	198.619	7881.690	0.00	1200.0	322.491	8116.931	0.00
510.0	199.413	7886.419	0.00	1210.0	324.509	8119.669	0.00
520.0	200.290	7891.052	0.00	1220.0	326.525	8122.398	0.00
530.0	201.243	7895.597	0.00	1230.0	328.541	8125.119	0.00
540.0	202.269	7900.057	0.00	1240.0	330.556	8127.830	0.00
550.0	203.360	7904.439	0.00	1250.0	332.569	8130.533	0.00
560.0	204.513	7908.748	0.00	1260.0	334.582	8133.228	0.00
570.0	205.724	7912.987	0.00	1270.0	336.593	8135.914	0.00
580.0	206.988	7917.161	0.00	1280.0	338.602	8138.592	0.00
590.0	208.301	7921.273	0.00	1290.0	340.610	8141.262	0.00
600.0	209.662	7925.326	0.00	1300.0	342.617	8143.925	0.00
610.0	211.065	7929.325	0.00	1310.0	344.622	8146.579	0.00
620.0	212.509	7933.271	0.00	1320.0	346.625	8149.225	0.00
630.0	213.991	7937.167	0.00	1330.0	348.626	8151.864	0.00
640.0	215.509	7941.016	0.00	1340.0	350.626	8154.495	0.00
650.0	217.059	7944.820	0.00	1350.0	352.623	8157.119	0.00
660.0	218.641	7948.582	0.00	1360.0	354.619	8159.735	0.00
670.0	220.252	7952.302	0.00	1370.0	356.612	8162.344	0.00
680.0	221.891	7955.984	0.00	1380.0	358.604	8164.946	0.00
690.0	223.555	7959.628	0.00	1390.0	360.593	8167.540	0.00
700.0	225.243	7963.236	0.00	1400.0	362.580	8170.128	0.00
710.0	226.954	7966.811	0.00	1410.0	364.565	8172.709	0.00
720.0	228.686	7970.353	0.00	1420.0	366.547	8175.282	0.00
730.0	230.438	7973.863	0.00	1430.0	368.528	8177.849	0.00
740.0	232.209	7977.343	0.00	1440.0	370.505	8180.409	0.00
750.0	233.998	7980.795	0.00	1450.0	372.481	8182.963	0.00
760.0	235.803	7984.218	0.00	1460.0	374.454	8185.509	0.00
770.0	237.624	7987.615	0.00	1470.0	376.424	8188.050	0.00
780.0	239.459	7990.985	0.00	1480.0	378.392	8190.583	0.00
790.0	241.308	7994.331	0.00	1490.0	380.357	8193.111	0.00
800.0	243.171	7997.653	0.00	1500.0	382.319	8195.632	0.00

## Угол входа — 3,0 град

Н, км	DVT, м/с	VBX, м/с	TETA, ГРАД	Н, км	DVT, м/с	VBX, м/с	TETA, ГРАД
110.0	2141.474	5713.050	73.47	810.0	248.454	7997.883	0.00
120.0	1325.903	6535.007	78.13	820.0	250.297	8001.202	0.00
130.0	936.412	6900.660	78.55	830.0	252.151	8004.498	0.00
140.0	763.935	7109.218	77.05	840.0	254.016	8007.772	0.00
150.0	634.448	7244.745	74.26	850.0	255.892	8011.024	0.00
160.0	544.872	7440.330	70.41	860.0	257.778	8014.256	0.00
170.0	479.513	7411.676	65.60	870.0	259.673	8017.468	0.00
180.0	429.953	7467.203	59.80	880.0	261.577	8020.660	0.00
190.0	391.273	7511.832	52.89	890.0	263.489	8023.833	0.00
200.0	360.405	7548.633	44.51	900.0	265.408	8026.987	0.00
210.0	335.334	7579.622	33.82	910.0	267.335	8030.124	0.00
220.0	314.682	7605.176	17.16	920.0	269.268	8033.243	0.00
230.0	297.478	7629.268	0.00	930.0	271.207	8036.346	0.00
240.0	283.013	7649.606	0.00	940.0	273.153	8039.431	0.00
250.0	270.760	7667.717	0.00	950.0	275.104	8042.501	0.00
260.0	260.321	7684.002	0.00	960.0	277.059	8045.555	0.00
270.0	251.384	7698.769	0.00	970.0	279.020	8048.594	0.00
280.0	243.709	7712.262	0.00	980.0	280.985	8051.618	0.00
290.0	237.100	7724.675	0.00	990.0	282.954	8054.627	0.00
300.0	231.402	7736.163	0.00	1000.0	284.927	8057.623	0.00
310.0	226.488	7746.855	0.00	1010.0	286.903	8060.604	0.00
320.0	222.253	7756.854	0.00	1020.0	288.882	8063.572	0.00
330.0	218.609	7766.248	0.00	1030.0	290.864	8066.526	0.00
340.0	215.485	7775.110	0.00	1040.0	292.849	8069.468	0.00
350.0	212.818	7783.501	0.00	1050.0	294.836	8072.397	0.00
360.0	210.557	7791.474	0.00	1060.0	296.825	8075.313	0.00
370.0	208.655	7799.074	0.00	1070.0	298.816	8078.218	0.00
380.0	207.076	7806.338	0.00	1080.0	300.809	8081.110	0.00
390.0	205.785	7813.302	0.00	1090.0	302.804	8083.991	0.00
400.0	204.755	7819.992	0.00	1100.0	304.799	8086.850	0.00
410.0	203.958	7826.436	0.00	1110.0	306.796	8089.719	0.00
420.0	203.374	7832.655	0.00	1120.0	308.794	8092.566	0.00
430.0	202.983	7838.668	0.00	1130.0	310.792	8095.402	0.00
440.0	202.767	7844.493	0.00	1140.0	312.791	8098.228	0.00
450.0	202.711	7850.146	0.00	1150.0	314.791	8101.043	0.00
460.0	202.801	7855.639	0.00	1160.0	316.791	8103.848	0.00
470.0	203.026	7860.985	0.00	1170.0	318.790	8106.643	0.00
480.0	203.374	7866.197	0.00	1180.0	320.790	8109.428	0.00
490.0	203.836	7871.283	0.00	1190.0	322.790	8112.203	0.00
500.0	204.402	7876.251	0.00	1200.0	324.790	8114.959	0.00
510.0	205.064	7881.111	0.00	1210.0	326.789	8117.725	0.00
520.0	205.816	7885.859	0.00	1220.0	328.787	8120.472	0.00
530.0	206.651	7890.532	0.00	1230.0	330.785	8123.210	0.00
540.0	207.563	7895.107	0.00	1240.0	332.782	8125.939	0.00
550.0	208.545	7899.598	0.00	1250.0	334.779	8128.659	0.00
560.0	209.594	7904.010	0.00	1260.0	336.774	8131.371	0.00
570.0	210.705	7908.349	0.00	1270.0	338.768	8134.074	0.00
580.0	211.873	7912.619	0.00	1280.0	340.762	8136.768	0.00
590.0	213.094	7916.823	0.00	1290.0	342.754	8139.454	0.00
600.0	214.365	7920.965	0.00	1300.0	344.744	8142.132	0.00
610.0	215.684	7925.049	0.00	1310.0	346.734	8144.801	0.00
620.0	217.046	7929.076	0.00	1320.0	348.722	8147.463	0.00
630.0	218.449	7933.052	0.00	1330.0	350.708	8150.116	0.00
640.0	219.890	7936.977	0.00	1340.0	352.693	8152.762	0.00
650.0	221.368	7940.854	0.00	1350.0	354.676	8155.400	0.00
660.0	222.879	7944.685	0.00	1360.0	356.657	8158.031	0.00
670.0	224.421	7948.475	0.00	1370.0	358.636	8160.654	0.00
680.0	225.994	7952.223	0.00	1380.0	360.614	8163.269	0.00
690.0	227.594	7955.931	0.00	1390.0	362.590	8165.878	0.00
700.0	229.220	7959.601	0.00	1400.0	364.563	8168.478	0.00
710.0	230.871	7963.236	0.00	1410.0	366.535	8171.072	0.00
720.0	232.546	7966.835	0.00	1420.0	368.504	8173.659	0.00
730.0	234.242	7970.402	0.00	1430.0	370.472	8176.238	0.00
740.0	235.958	7973.936	0.00	1440.0	372.437	8178.811	0.00
750.0	237.694	7977.440	0.00	1450.0	374.399	8181.377	0.00
760.0	239.448	7980.915	0.00	1460.0	376.360	8183.936	0.00
770.0	241.219	7984.361	0.00	1470.0	378.318	8186.488	0.00
780.0	243.005	7987.780	0.00	1480.0	380.274	8189.034	0.00
790.0	244.808	7991.173	0.00	1490.0	382.227	8191.573	0.00
800.0	246.624	7994.540	0.00	1500.0	384.178	8194.105	0.00



Угол входа — 3.1 град

Н, мм	DVT, м/с	VBX, м/с	ТЕТА, ГРАД	Н, мм	DVT, м/с	VBX, м/с	ТЕТА, ГРАД
110.0	2230.518	5624.269	72.82	810.0	251.975	7994.714	0.00
120.0	1393.089	6468.132	77.73	820.0	253.773	7998.078	0.00
130.0	1019.351	6848.039	78.38	830.0	255.584	8001.417	0.00
140.0	807.452	7066.030	77.12	840.0	257.407	8004.733	0.00
150.0	671.347	7208.180	74.60	850.0	259.242	8008.027	0.00
160.0	576.890	7308.651	71.06	860.0	261.087	8011.298	0.00
170.0	507.788	7383.743	66.60	870.0	262.943	8014.549	0.00
180.0	455.270	7442.230	61.23	880.0	264.809	8017.779	0.00
190.0	414.195	7489.256	54.85	890.0	266.684	8020.989	0.00
200.0	381.348	7528.038	47.22	900.0	268.567	8024.179	0.00
210.0	354.615	7560.689	37.77	910.0	270.458	8027.351	0.00
220.0	332.549	7588.659	24.68	920.0	272.357	8030.505	0.00
230.0	314.125	7612.972	0.00	930.0	274.263	8033.641	0.00
240.0	298.598	7634.372	0.00	940.0	276.176	8036.759	0.00
250.0	285.413	7663.417	0.00	950.0	278.094	8039.861	0.00
260.0	274.147	7670.528	0.00	960.0	280.019	8042.945	0.00
270.0	264.475	7686.032	0.00	970.0	281.949	8046.016	0.00
280.0	256.139	7700.185	0.00	980.0	283.884	8049.070	0.00
290.0	248.934	7713.194	0.00	990.0	285.823	8052.108	0.00
300.0	242.696	7725.223	0.00	1000.0	287.767	8055.132	0.00
310.0	237.230	7736.407	0.00	1010.0	289.715	8058.141	0.00
320.0	232.604	7746.856	0.00	1020.0	291.667	8061.137	0.00
330.0	228.548	7756.664	0.00	1030.0	293.622	8064.118	0.00
340.0	225.043	7765.906	0.00	1040.0	295.581	8067.089	0.00
350.0	222.024	7774.650	0.00	1050.0	297.542	8070.040	0.00
360.0	219.436	7782.949	0.00	1060.0	299.505	8072.982	0.00
370.0	217.232	7790.852	0.00	1070.0	301.472	8075.911	0.00
380.0	215.370	7798.400	0.00	1080.0	303.441	8078.828	0.00
390.0	213.815	7805.627	0.00	1090.0	305.412	8081.732	0.00
400.0	212.537	7812.565	0.00	1100.0	307.384	8084.625	0.00
410.0	211.508	7819.241	0.00	1110.0	309.358	8087.506	0.00
420.0	210.706	7825.678	0.00	1120.0	311.333	8090.375	0.00
430.0	210.109	7831.896	0.00	1130.0	313.310	8093.233	0.00
440.0	209.699	7837.916	0.00	1140.0	315.287	8096.080	0.00
450.0	209.460	7843.751	0.00	1150.0	317.265	8098.917	0.00
460.0	209.377	7849.418	0.00	1160.0	319.244	8101.742	0.00
470.0	209.437	7854.930	0.00	1170.0	321.224	8104.557	0.00
480.0	209.629	7860.297	0.00	1180.0	323.204	8107.362	0.00
490.0	209.942	7865.531	0.00	1190.0	325.184	8110.157	0.00
500.0	210.367	7870.640	0.00	1200.0	327.164	8112.942	0.00
510.0	210.895	7875.635	0.00	1210.0	329.144	8115.717	0.00
520.0	211.519	7880.521	0.00	1220.0	331.124	8118.483	0.00
530.0	212.231	7885.307	0.00	1230.0	333.103	8121.239	0.00
540.0	213.025	7889.998	0.00	1240.0	335.083	8123.986	0.00
550.0	213.896	7894.601	0.00	1250.0	337.061	8126.724	0.00
560.0	214.837	7899.122	0.00	1260.0	339.039	8129.452	0.00
570.0	215.845	7903.564	0.00	1270.0	341.016	8132.172	0.00
580.0	216.914	7907.932	0.00	1280.0	342.993	8134.883	0.00
590.0	218.041	7912.231	0.00	1290.0	344.968	8137.586	0.00
600.0	219.221	7916.464	0.00	1300.0	346.943	8140.279	0.00
610.0	220.452	7920.635	0.00	1310.0	348.916	8142.966	0.00
620.0	221.729	7924.748	0.00	1320.0	350.888	8145.642	0.00
630.0	223.051	7928.804	0.00	1330.0	352.859	8148.311	0.00
640.0	224.414	7932.807	0.00	1340.0	354.829	8150.972	0.00
650.0	225.815	7936.761	0.00	1350.0	356.797	8153.625	0.00
660.0	227.253	7940.666	0.00	1360.0	358.763	8156.270	0.00
670.0	228.725	7944.525	0.00	1370.0	360.728	8158.908	0.00
680.0	230.230	7948.340	0.00	1380.0	362.691	8161.537	0.00
690.0	231.764	7952.114	0.00	1390.0	364.653	8164.160	0.00
700.0	233.326	7955.849	0.00	1400.0	366.612	8166.774	0.00
710.0	234.916	7959.544	0.00	1410.0	368.570	8169.381	0.00
720.0	236.530	7963.204	0.00	1420.0	370.526	8171.981	0.00
730.0	238.168	7966.828	0.00	1430.0	372.480	8174.574	0.00
740.0	239.829	7970.419	0.00	1440.0	374.432	8177.160	0.00
750.0	241.510	7973.977	0.00	1450.0	376.382	8179.738	0.00
760.0	243.211	7977.505	0.00	1460.0	378.330	8182.310	0.00
770.0	244.930	7981.002	0.00	1470.0	380.275	8184.875	0.00
780.0	246.668	7984.471	0.00	1480.0	382.219	8187.433	0.00
790.0	248.421	7987.912	0.00	1490.0	384.160	8189.984	0.00
800.0	250.191	7991.326	0.00	1500.0	386.099	8192.528	0.00

## Угол входа — 3.2 град

Н, км	DVT, м/с	VBX, м/с	ТЕТА, ГРАД	Н, км	DVT, м/с	VBX, м/с	ТЕТА, ГРАД
110.0	2318.257	5536.799	72.17	810.0	255.606	7991.446	0.00
120.0	1460.337	6401.183	77.32	820.0	257.358	7994.855	0.00
130.0	1072.773	6794.944	78.19	830.0	259.125	7998.239	0.00
140.0	851.571	7022.248	77.16	840.0	260.904	8001.599	0.00
150.0	708.875	7170.996	74.88	850.0	262.697	8004.934	0.00
160.0	609.526	7276.364	71.62	860.0	264.501	8008.247	0.00
170.0	536.656	7355.226	67.48	870.0	266.317	8011.538	0.00
180.0	481.152	7416.703	62.49	880.0	268.144	8014.807	0.00
190.0	437.653	7466.155	56.58	890.0	269.980	8018.055	0.00
200.0	402.799	7506.945	49.58	900.0	271.826	8021.283	0.00
210.0	374.377	7541.287	41.09	910.0	273.681	8024.491	0.00
220.0	350.871	7570.697	30.03	920.0	275.544	8027.680	0.00
230.0	331.205	7596.252	10.35	930.0	277.415	8030.851	0.00
240.0	314.596	7618.736	0.00	940.0	279.294	8034.003	0.00
250.0	300.459	7638.733	0.00	950.0	281.180	8037.138	0.00
260.0	288.351	7656.688	0.00	960.0	283.072	8040.255	0.00
270.0	277.926	7672.944	0.00	970.0	284.970	8043.356	0.00
280.0	268.915	7687.774	0.00	980.0	285.874	8046.441	0.00
290.0	261.101	7701.392	0.00	990.0	288.784	8049.509	0.00
300.0	254.310	7713.974	0.00	1000.0	290.698	8052.563	0.00
310.0	248.400	7725.662	0.00	1010.0	292.617	8055.601	0.00
320.0	243.253	7736.573	0.00	1020.0	294.540	8058.624	0.00
330.0	238.773	7746.804	0.00	1030.0	296.468	8061.633	0.00
340.0	234.878	7756.437	0.00	1040.0	298.399	8064.628	0.00
350.0	231.498	7765.541	0.00	1050.0	300.334	8067.609	0.00
360.0	228.576	7774.175	0.00	1060.0	302.272	8070.577	0.00
370.0	226.060	7782.383	0.00	1070.0	304.213	8073.531	0.00
380.0	223.908	7790.227	0.00	1080.0	306.156	8076.473	0.00
390.0	222.082	7797.726	0.00	1090.0	308.103	8079.401	0.00
400.0	220.550	7804.918	0.00	1100.0	310.051	8082.318	0.00
410.0	219.284	7811.832	0.00	1110.0	312.001	8085.222	0.00
420.0	218.257	7818.493	0.00	1120.0	313.953	8088.115	0.00
430.0	217.449	7824.922	0.03	1130.0	315.907	8090.995	0.00
440.0	216.840	7831.141	0.00	1140.0	317.862	8093.865	0.00
450.0	216.413	7837.165	0.00	1150.0	319.819	8096.723	0.00
460.0	216.152	7843.010	0.00	1160.0	321.776	8099.570	0.00
470.0	216.043	7848.690	0.00	1170.0	323.735	8102.406	0.00
480.0	216.075	7854.218	0.00	1180.0	325.694	8105.231	0.00
490.0	216.235	7859.604	0.00	1190.0	327.654	8108.046	0.00
500.0	216.515	7864.859	0.00	1200.0	329.614	8110.851	0.00
510.0	216.905	7869.992	0.03	1210.0	331.574	8113.646	0.00
520.0	217.396	7875.010	0.00	1220.0	333.535	8116.430	0.00
530.0	217.982	7879.922	0.00	1230.0	335.496	8119.205	0.00
540.0	218.656	7884.734	0.00	1240.0	337.456	8121.970	0.00
550.0	219.411	7889.452	0.00	1250.0	339.417	8124.726	0.00
560.0	220.242	7894.083	0.00	1260.0	341.377	8127.473	0.00
570.0	221.144	7898.631	0.00	1270.0	343.337	8130.210	0.00
580.0	222.111	7903.101	0.00	1280.0	345.296	8132.938	0.00
590.0	223.140	7907.497	0.00	1290.0	347.254	8135.658	0.00
600.0	224.227	7911.824	0.00	1300.0	349.212	8138.368	0.00
610.0	225.367	7916.085	0.00	1310.0	351.168	8141.070	0.00
620.0	226.558	7920.285	0.00	1320.0	353.124	8143.763	0.00
630.0	227.795	7924.425	0.00	1330.0	355.079	8146.448	0.00
640.0	229.078	7928.509	0.00	1340.0	357.033	8149.125	0.00
650.0	230.401	7932.540	0.00	1350.0	358.985	8151.793	0.00
660.0	231.764	7936.520	0.00	1360.0	360.937	8154.453	0.00
670.0	233.164	7940.452	0.00	1370.0	362.886	8157.106	0.00
680.0	234.598	7944.337	0.00	1380.0	364.835	8159.750	0.00
690.0	236.064	7948.179	0.00	1390.0	366.782	8162.387	0.00
700.0	237.561	7951.979	0.00	1400.0	368.727	8165.015	0.00
710.0	239.087	7955.738	0.00	1410.0	370.671	8167.637	0.00
720.0	240.640	7959.459	0.00	1420.0	372.613	8170.251	0.00
730.0	242.218	7963.143	0.00	1430.0	374.553	8172.857	0.00
740.0	243.820	7966.791	0.00	1440.0	376.492	8175.456	0.00
750.0	245.446	7970.406	0.00	1450.0	378.428	8178.048	0.00
760.0	247.092	7973.987	0.00	1460.0	380.363	8180.632	0.00
770.0	248.759	7977.538	0.00	1470.0	382.296	8183.210	0.00
780.0	250.445	7981.057	0.00	1480.0	384.226	8185.780	0.00
790.0	252.149	7984.548	0.00	1490.0	386.155	8188.344	0.00
800.0	253.870	7988.011	0.00	1500.0	388.081	8190.900	0.00

## Угол входа — 3,3 град

Н, мм	DVT, м/с	VBX, м/с	TETA, ГРАД	Н, мм	DVT, м/с	VBX, м/с	TETA, ГРАД
110.0	2404.620	5450.708	71.53	810.0	259.349	7988.079	0.00
120.0	1627.584	6334.251	76.90	820.0	261.053	7991.535	0.00
130.0	1126.607	6741.444	77.98	830.0	262.774	7994.965	0.00
140.0	896.241	6977.924	77.15	840.0	264.509	7998.369	0.00
150.0	746.990	7133.234	75.10	850.0	266.258	8001.748	0.00
160.0	642.747	7243.500	72.10	860.0	268.020	8005.104	0.00
170.0	566.093	7326.151	68.26	870.0	269.794	8008.435	0.00
180.0	507.577	7390.642	63.61	880.0	271.580	8011.745	0.00
190.0	461.628	7442.647	58.12	890.0	273.377	8015.032	0.00
200.0	424.741	7485.371	51.65	900.0	275.185	8018.298	0.00
210.0	394.607	7521.426	43.94	910.0	277.002	8021.544	0.00
220.0	369.639	7552.300	34.26	920.0	278.829	8024.769	0.00
230.0	348.710	7579.119	20.16	930.0	280.664	8027.975	0.00
240.0	330.999	7602.706	0.00	940.1	282.508	8031.162	0.00
250.0	315.892	7623.673	0.00	950.0	284.360	8034.331	0.00
260.0	302.924	7642.488	0.00	960.0	283.219	8037.482	0.00
270.0	291.732	7659.513	0.00	970.0	288.084	8040.615	0.00
280.0	282.031	7675.032	0.00	980.0	289.956	8043.731	0.00
290.0	273.595	7689.274	0.00	990.0	291.835	8046.831	0.00
300.0	266.239	7702.421	0.00	1000.0	293.719	8049.915	0.00
310.0	259.813	7714.625	0.00	1010.0	295.608	8052.982	0.00
320.0	254.196	7726.007	0.00	1020.0	297.502	8056.035	0.00
330.0	249.282	7736.671	0.00	1030.0	299.401	8059.072	0.00
340.0	244.988	7746.704	0.00	1040.0	301.305	8062.095	0.00
350.0	241.239	7756.178	0.00	1050.0	303.212	8065.103	0.00
360.0	237.973	7765.155	0.00	1060.0	305.123	8068.098	0.00
370.0	235.139	7773.688	0.00	1070.0	307.038	8071.078	0.00
380.0	232.690	7781.823	0.00	1080.0	308.956	8074.045	0.00
390.0	230.586	7789.600	0.00	1090.0	310.876	8076.999	0.00
400.0	228.794	7797.052	0.00	1100.0	312.800	8079.940	0.00
410.0	227.283	7804.210	0.00	1110.0	314.726	8082.869	0.00
420.0	226.026	7811.101	0.00	1120.0	316.654	8085.785	0.00
430.0	225.002	7817.747	0.00	1130.0	318.585	8088.689	0.00
440.0	224.189	7824.170	0.00	1140.0	320.517	8091.581	0.00
450.0	223.568	7830.387	0.00	1150.0	322.451	8094.461	0.00
460.0	223.124	7836.415	0.00	1160.0	324.386	8097.330	0.00
470.0	222.842	7842.269	0.00	1170.0	326.323	8100.188	0.00
480.0	222.709	7847.962	0.00	1180.0	328.261	8103.034	0.00
490.0	222.713	7853.504	0.00	1190.0	330.200	8105.870	0.00
500.0	222.843	7858.908	0.00	1200.0	332.140	8108.695	0.00
510.0	223.091	7864.183	0.00	1210.0	334.080	8111.510	0.00
520.0	223.447	7869.337	0.00	1220.0	336.021	8114.314	0.00
530.0	223.904	7874.378	0.00	1230.0	337.962	8117.108	0.00
540.0	224.453	7879.314	0.00	1240.0	339.904	8119.893	0.00
550.0	225.090	7884.151	0.00	1250.0	341.845	8122.667	0.00
560.0	225.807	7888.895	0.00	1260.0	343.787	8125.432	0.00
570.0	226.600	7893.551	0.00	1270.0	345.728	8128.187	0.00
580.0	227.463	7898.126	0.00	1280.0	347.670	8130.933	0.00
590.0	228.392	7902.623	0.00	1290.0	349.610	8133.670	0.00
600.0	229.382	7907.046	0.00	1300.0	351.551	8136.398	0.00
610.0	230.429	7911.400	0.00	1310.0	353.490	8139.116	0.00
620.0	231.530	7915.689	0.00	1320.0	355.430	8141.826	0.00
630.0	232.682	7919.915	0.00	1330.0	357.368	8144.528	0.00
640.0	233.881	7924.082	0.00	1340.0	359.306	8147.220	0.00
650.0	235.125	7928.193	0.00	1350.0	361.242	8149.904	0.00
660.0	236.411	7932.250	0.00	1360.0	363.178	8152.580	0.00
670.0	237.735	7936.256	0.00	1370.0	365.112	8155.248	0.00
680.0	239.097	7940.214	0.00	1380.0	367.045	8157.907	0.00
690.0	240.494	7944.126	0.00	1390.0	368.977	8160.559	0.00
700.0	241.923	7947.993	0.00	1400.0	370.908	8163.202	0.00
710.0	243.384	7951.817	0.00	1410.0	372.837	8165.838	0.00
720.0	244.873	7955.601	0.00	1420.0	374.765	8168.466	0.00
730.0	246.390	7959.346	0.00	1430.0	376.691	8171.085	0.00
740.0	247.933	7963.054	0.00	1440.0	378.615	8173.699	0.00
750.0	249.501	7966.726	0.00	1450.0	380.538	8176.304	0.00
760.0	251.091	7970.364	0.00	1460.0	382.459	8178.902	0.00
770.0	252.704	7973.968	0.00	1470.0	384.379	8181.493	0.00
780.0	254.337	7977.541	0.00	1480.0	386.296	8184.077	0.00
790.0	255.989	7981.083	0.00	1490.0	388.212	8186.653	0.00
800.0	257.660	7984.595	0.00	1500.0	390.125	8189.222	0.00

## Угол входа — 3,4 град

Н, км	DVT, м/с	VBX, м/с	ТЕТА, ГРАД	Н, км	DVT, м/с	VBX, м/с	ТЕТА, ГРАД
110.0	2489.551	5356.052	70.89	810.0	263.201	7984.613	0.00
120.0	1594.736	6267.420	76.47	820.0	264.857	7988.118	0.00
130.0	1180.785	6587.607	77.74	830.0	265.530	7991.595	0.00
140.0	941.410	6933.109	77.12	840.0	268.219	7995.045	0.00
150.0	785.653	7091.932	75.28	850.0	269.923	7998.469	0.00
160.0	676.522	7210.092	72.52	860.0	271.642	8001.857	0.00
170.0	595.071	7296.544	68.95	870.0	273.373	8005.242	0.00
180.0	534.526	7361.068	64.61	880.0	275.118	8008.592	0.00
190.0	485.103	7418.448	59.49	890.0	276.875	8011.920	0.00
200.0	447.161	7463.330	53.50	900.0	278.643	8015.225	0.00
210.0	415.293	7501.121	46.42	910.0	280.422	8018.509	0.00
220.0	388.841	7533.479	37.77	920.0	282.211	8021.772	0.00
230.0	366.629	7561.583	26.19	930.0	284.010	8025.015	0.00
240.0	347.798	7585.290	0.00	940.0	285.818	8028.238	0.00
250.0	331.705	7608.245	0.00	950.0	287.634	8031.441	0.00
260.0	317.851	7627.936	0.00	960.0	289.459	8034.626	0.00
270.0	305.887	7645.744	0.00	970.0	291.291	8037.793	0.00
280.0	295.483	7661.957	0.00	980.0	293.130	8040.942	0.00
290.0	285.411	7676.844	0.00	990.0	294.977	8044.074	0.00
300.0	278.478	7690.569	0.00	1000.0	296.829	8047.188	0.00
310.0	271.527	7703.298	0.00	1010.0	298.688	8050.287	0.00
320.0	265.427	7715.163	0.00	1020.0	300.552	8053.369	0.00
330.0	260.071	7726.270	0.00	1030.0	302.422	8056.435	0.00
340.0	255.368	7736.711	0.00	1040.0	304.296	8059.487	0.00
350.0	251.241	7746.563	0.00	1050.0	306.176	8062.523	0.00
360.0	247.625	7755.891	0.00	1060.0	308.059	8065.545	0.00
370.0	244.465	7764.751	0.00	1070.0	309.947	8068.552	0.00
380.0	241.711	7773.190	0.00	1080.0	311.838	8071.546	0.00
390.0	239.323	7781.251	0.00	1090.0	313.733	8074.526	0.00
400.0	237.264	7788.970	0.00	1100.0	315.631	8077.492	0.00
410.0	235.503	7796.379	0.00	1110.0	317.532	8080.445	0.00
420.0	234.011	7803.505	0.00	1120.0	319.436	8083.386	0.00
430.0	232.765	7810.373	0.00	1130.0	321.342	8086.313	0.00
440.0	231.742	7817.005	0.00	1140.0	323.251	8089.229	0.00
450.0	230.924	7823.421	0.00	1150.0	325.162	8092.132	0.00
460.0	230.292	7829.636	0.00	1160.0	327.075	8095.024	0.00
470.0	229.832	7835.668	0.00	1170.0	328.989	8097.904	0.00
480.0	229.530	7841.529	0.00	1180.0	330.905	8100.772	0.00
490.0	229.374	7847.233	0.00	1190.0	332.823	8103.629	0.00
500.0	229.351	7852.789	0.00	1200.0	334.741	8106.475	0.00
510.0	229.453	7858.210	0.00	1210.0	336.661	8109.310	0.00
520.0	229.670	7863.503	0.00	1220.0	338.581	8112.135	0.00
530.0	229.994	7868.677	0.00	1230.0	340.502	8114.949	0.00
540.0	230.416	7873.740	0.00	1240.0	342.424	8117.753	0.00
550.0	230.931	7878.698	0.00	1250.0	344.347	8120.547	0.00
560.0	231.532	7883.558	0.00	1260.0	346.269	8123.330	0.00
570.0	232.213	7888.327	0.00	1270.0	348.192	8126.104	0.00
580.0	232.939	7893.008	0.00	1280.0	350.115	8128.859	0.00
590.0	233.795	7897.608	0.00	1290.0	352.037	8131.623	0.00
600.0	234.685	7902.131	0.00	1300.0	353.960	8134.339	0.00
610.0	235.638	7906.580	0.00	1310.0	355.882	8137.105	0.00
620.0	236.647	7910.960	0.00	1320.0	357.804	8139.832	0.00
630.0	237.711	7915.275	0.00	1330.0	359.726	8142.550	0.00
640.0	238.825	7919.527	0.00	1340.0	361.646	8145.259	0.00
650.0	239.986	7923.720	0.00	1350.0	363.566	8147.959	0.00
660.0	241.192	7927.856	0.00	1360.0	365.485	8150.651	0.00
670.0	242.440	7931.939	0.00	1370.0	367.404	8153.335	0.00
680.0	243.728	7935.971	0.00	1380.0	369.322	8156.010	0.00
690.0	245.053	7939.954	0.00	1390.0	371.238	8158.676	0.00
700.0	246.413	7943.891	0.00	1400.0	373.154	8161.335	0.00
710.0	247.806	7947.782	0.00	1410.0	375.068	8163.985	0.00
720.0	249.231	7951.631	0.00	1420.0	376.981	8166.628	0.00
730.0	250.685	7955.439	0.00	1430.0	378.892	8169.263	0.00
740.0	252.166	7959.208	0.00	1440.0	380.803	8171.890	0.00
750.0	253.675	7962.940	0.00	1450.0	382.711	8174.509	0.00
760.0	255.208	7966.635	0.00	1460.0	384.619	8177.121	0.00
770.0	256.764	7970.295	0.00	1470.0	386.524	8179.725	0.00
780.0	258.343	7973.922	0.00	1480.0	388.428	8182.322	0.00
790.0	259.943	7977.516	0.00	1490.0	390.331	8184.911	0.00
800.0	261.562	7981.080	0.00	1500.0	392.231	8187.494	0.00

## Угол входа — 3,5 град

Н, мм	DVT, м/с	VBX, м/с	ТЕТА, ГРАД	Н, мм	DVT, м/с	VBX, м/с	ТЕТА, ГРАД
110.0	2573.005	5282.876	70.26	810.0	267.163	7981.049	0.00
120.0	1661.716	6200.768	76.04	820.0	268.769	7984.604	0.00
130.0	1235.246	6633.497	77.50	830.0	270.393	7988.129	0.00
140.0	987.028	6887.833	77.05	840.0	272.035	7991.626	0.00
150.0	824.826	7056.130	75.42	850.0	273.693	7995.096	0.00
160.0	710.821	7176.170	72.87	860.0	275.367	7998.539	0.00
170.0	626.567	7266.429	69.55	870.0	277.055	8001.957	0.00
180.0	561.976	7337.002	65.50	880.0	278.757	8005.350	0.00
190.0	511.061	7393.877	60.72	890.0	280.472	8008.719	0.00
200.0	470.044	7440.835	55.14	900.0	282.200	8012.065	0.00
210.0	436.421	7480.383	48.60	910.0	283.939	8015.389	0.00
220.0	408.467	7514.246	40.76	920.0	285.690	8018.690	0.00
230.0	384.954	7543.651	30.77	930.0	287.451	8021.970	0.00
240.0	364.985	7569.497	14.98	940.0	289.222	8025.230	0.00
250.0	347.889	7592.456	0.00	950.0	291.002	8028.469	0.00
260.0	333.155	7613.038	0.00	960.0	292.792	8031.689	0.00
270.0	320.384	7631.643	0.00	970.0	294.589	8034.890	0.00
280.0	309.264	7648.582	0.00	980.0	296.395	8038.073	0.00
290.0	299.545	7664.107	0.00	990.0	298.209	8041.237	0.00
300.0	291.024	7678.421	0.00	1000.0	300.029	8044.384	0.00
310.0	283.535	7691.687	0.00	1010.0	301.856	8047.513	0.00
320.0	276.945	7704.044	0.00	1020.0	303.690	8050.626	0.00
330.0	271.137	7715.604	0.00	1030.0	305.529	8053.723	0.00
340.0	266.015	7726.462	0.00	1040.0	307.374	8056.804	0.00
350.0	261.503	7736.700	0.00	1050.0	309.224	8059.869	0.00
360.0	257.529	7746.387	0.00	1060.0	311.080	8062.919	0.00
370.0	254.035	7755.580	0.00	1070.0	312.939	8065.954	0.00
380.0	250.970	7764.331	0.00	1080.0	314.804	8068.974	0.00
390.0	248.291	7772.683	0.00	1090.0	316.672	8071.981	0.00
400.0	245.960	7780.674	0.00	1100.0	318.544	8074.973	0.00
410.0	243.943	7788.339	0.00	1110.0	320.419	8077.952	0.00
420.0	242.210	7795.703	0.00	1120.0	322.298	8080.917	0.00
430.0	240.737	7802.802	0.00	1130.0	324.180	8083.870	0.00
440.0	239.500	7809.648	0.00	1140.0	326.054	8086.809	0.00
450.0	238.478	7816.266	0.00	1150.0	327.951	8089.736	0.00
460.0	237.655	7822.674	0.00	1160.0	329.841	8092.651	0.00
470.0	237.012	7828.888	0.00	1170.0	331.732	8095.554	0.00
480.0	236.537	7834.922	0.00	1180.0	333.626	8098.444	0.00
490.0	236.216	7840.790	0.00	1190.0	335.521	8101.324	0.00
500.0	236.037	7846.504	0.00	1200.0	337.418	8104.191	0.00
510.0	235.990	7852.073	0.00	1210.0	339.316	8107.048	0.00
520.0	236.064	7857.509	0.00	1220.0	341.216	8109.893	0.00
530.0	236.252	7862.819	0.00	1230.0	343.116	8112.728	0.00
540.0	236.544	7868.012	0.00	1240.0	345.018	8115.552	0.00
550.0	236.934	7873.095	0.00	1250.0	346.920	8118.365	0.00
560.0	237.416	7878.075	0.00	1260.0	348.823	8121.168	0.00
570.0	237.982	7882.958	0.00	1270.0	350.727	8123.961	0.00
580.0	238.628	7887.749	0.00	1280.0	352.631	8126.744	0.00
590.0	239.348	7892.455	0.00	1290.0	354.535	8129.517	0.00
600.0	240.137	7897.079	0.00	1300.0	356.439	8132.281	0.00
610.0	240.991	7901.626	0.00	1310.0	358.343	8135.035	0.00
620.0	241.907	7906.100	0.00	1320.0	360.248	8137.779	0.00
630.0	242.880	7910.505	0.00	1330.0	362.152	8140.514	0.00
640.0	243.905	7914.845	0.00	1340.0	364.055	8143.241	0.00
650.0	244.983	7919.122	0.00	1350.0	365.958	8145.958	0.00
660.0	246.108	7923.340	0.00	1360.0	367.861	8148.666	0.00
670.0	247.277	7927.502	0.00	1370.0	369.763	8151.366	0.00
680.0	248.489	7931.609	0.00	1380.0	371.665	8154.057	0.00
690.0	249.740	7935.666	0.00	1390.0	373.565	8156.739	0.00
700.0	251.029	7939.673	0.00	1400.0	375.465	8159.413	0.00
710.0	252.353	7943.634	0.00	1410.0	377.364	8162.079	0.00
720.0	253.711	7947.550	0.00	1420.0	379.262	8164.737	0.00
730.0	255.100	7951.422	0.00	1430.0	381.158	8167.386	0.00
740.0	256.519	7955.254	0.00	1440.0	383.054	8170.028	0.00
750.0	257.967	7959.046	0.00	1450.0	384.948	8172.661	0.00
760.0	259.441	7962.800	0.00	1460.0	386.841	8175.287	0.00
770.0	260.940	7966.517	0.00	1470.0	388.732	8177.906	0.00
780.0	262.463	7970.200	0.00	1480.0	390.623	8180.516	0.00
790.0	264.008	7973.849	0.00	1490.0	392.511	8183.119	0.00
800.0	265.575	7977.465	0.00	1500.0	394.398	8185.715	0.00



## Угол входа — 3,6 град

Н, мм	DVT, м/с	VBX, м/с	ТЕТА, ГРАД	Н, мм	DVT, м/с	VBX, м/с	ТЕТА, ГРАД
110.0	2654.951	5201.215	69.64	810.0	271.233	7977.388	0.00
120.0	1728.452	6134.365	75.60	820.0	272.789	7980.993	0.00
130.0	1289.924	6579.175	77.23	830.0	274.354	7984.568	0.00
140.0	1033.046	6842.205	76.96	840.0	275.957	7988.113	0.00
150.0	864.469	7016.856	75.51	850.0	277.568	7991.630	0.00
160.0	745.612	7141.764	73.17	850.0	279.195	7995.119	0.00
170.0	657.555	7235.832	70.05	870.0	283.839	7998.582	0.00
180.0	589.907	7309.464	66.29	880.0	282.497	8002.019	0.00
190.0	536.485	7368.819	61.82	890.0	284.169	8005.430	0.00
200.0	493.375	7417.903	56.60	900.0	285.855	8008.818	0.00
210.0	457.979	7459.226	50.53	910.0	287.554	8012.182	0.00
220.0	428.504	7494.610	43.36	920.0	289.265	8015.523	0.00
230.0	403.673	7525.335	34.50	930.0	290.987	8018.841	0.00
240.0	382.551	7552.336	22.17	940.0	292.721	8022.139	0.00
250.0	364.437	7576.313	7.75	950.0	294.464	8025.415	0.00
260.0	348.798	7597.801	0.00	960.0	296.217	8028.671	0.00
270.0	335.218	7617.216	0.00	970.0	297.983	8031.907	0.00
280.0	323.369	7634.885	0.00	980.0	299.751	8035.124	0.00
290.0	312.991	7651.070	0.00	990.0	301.531	8038.322	0.00
300.0	303.871	7665.982	0.00	1000.0	303.318	8041.501	0.00
310.0	295.836	7679.795	0.00	1010.0	305.113	8044.663	0.00
320.0	288.744	7692.664	0.00	1020.0	306.915	8047.808	0.00
330.0	282.474	7704.675	0.00	1030.0	308.723	8050.935	0.00
340.0	276.929	7715.960	0.00	1040.0	310.538	8054.046	0.00
350.0	272.022	7726.592	0.00	1050.0	312.359	8057.141	0.00
360.0	267.682	7736.645	0.00	1060.0	314.185	8060.220	0.00
370.0	263.847	7746.178	0.00	1070.0	316.016	8063.283	0.00
380.0	260.465	7755.247	0.00	1080.0	317.852	8066.332	0.00
390.0	257.489	7763.896	0.00	1090.0	319.693	8069.365	0.00
400.0	254.878	7772.167	0.00	1100.0	321.538	8072.384	0.00
410.0	252.599	7780.093	0.00	1110.0	323.387	8075.389	0.00
420.0	250.621	7787.707	0.00	1120.0	325.240	8078.380	0.00
430.0	248.915	7795.035	0.00	1130.0	327.096	8081.358	0.00
440.0	247.459	7802.101	0.00	1140.0	328.956	8084.322	0.00
450.0	246.230	7808.926	0.00	1150.0	330.819	8087.274	0.00
460.0	245.210	7815.530	0.00	1160.0	332.684	8090.212	0.00
470.0	244.381	7821.931	0.00	1170.0	334.552	8093.138	0.00
480.0	243.729	7828.142	0.00	1180.0	336.422	8096.052	0.00
490.0	243.239	7834.178	0.00	1190.0	338.295	8098.954	0.00
500.0	242.900	7840.052	0.00	1200.0	340.170	8101.843	0.00
510.0	242.700	7845.775	0.00	1210.0	342.046	8104.722	0.00
520.0	242.628	7851.356	0.00	1220.0	343.924	8107.588	0.00
530.0	242.676	7856.806	0.00	1230.0	345.804	8110.444	0.00
540.0	242.835	7862.132	0.00	1240.0	347.684	8113.288	0.00
550.0	243.098	7867.343	0.00	1250.0	349.566	8116.122	0.00
560.0	243.457	7872.445	0.00	1260.0	351.449	8118.945	0.00
570.0	243.905	7877.446	0.00	1270.0	353.333	8121.758	0.00
580.0	244.439	7882.350	0.00	1280.0	355.217	8124.560	0.00
590.0	245.050	7887.163	0.00	1290.0	357.103	8127.352	0.00
600.0	245.736	7891.891	0.00	1300.0	358.988	8130.134	0.00
610.0	246.490	7896.539	0.00	1310.0	360.874	8132.906	0.00
620.0	247.309	7901.109	0.00	1320.0	362.760	8135.669	0.00
630.0	248.189	7905.607	0.00	1330.0	364.646	8138.422	0.00
640.0	249.125	7910.036	0.00	1340.0	366.532	8141.166	0.00
650.0	250.116	7914.400	0.00	1350.0	368.418	8143.900	0.00
660.0	251.157	7918.701	0.00	1360.0	370.303	8146.625	0.00
670.0	252.246	7922.944	0.00	1370.0	372.189	8149.342	0.00
680.0	253.379	7927.129	0.00	1380.0	374.074	8152.049	0.00
690.0	254.555	7931.261	0.00	1390.0	375.958	8154.748	0.00
700.0	255.771	7935.342	0.00	1400.0	377.842	8157.438	0.00
710.0	257.025	7939.373	0.00	1410.0	379.725	8160.119	0.00
720.0	258.314	7943.357	0.00	1420.0	381.607	8162.792	0.00
730.0	259.637	7947.296	0.00	1430.0	383.488	8165.457	0.00
740.0	260.992	7951.192	0.00	1440.0	385.368	8168.114	0.00
750.0	262.376	7955.046	0.00	1450.0	387.248	8170.762	0.00
760.0	263.790	7958.850	0.00	1460.0	389.128	8173.402	0.00
770.0	265.230	7962.637	0.00	1470.0	391.003	8176.035	0.00
780.0	266.696	7966.376	0.00	1480.0	392.879	8178.660	0.00
790.0	268.186	7970.080	0.00	1490.0	394.753	8181.277	0.00
800.0	269.699	7973.750	0.00	1500.0	396.626	8183.886	0.00

## Угол входа — 3,7 град

Н, мм	DVT, м/с	VBX, м/с	ТЕТА, ГРАД	Н, мм	DVT, м/с	VBX, м/с	ТЕТА, ГРАД
110.0	2735.361	5121.091	69.03	810.0	275.413	7973.628	0.00
120.0	1794.878	6068.278	75.16	820.0	276.916	7977.283	0.00
130.0	1344.764	6524.698	76.95	830.0	278.440	7983.912	0.00
140.0	1079.418	6796.211	76.85	810.0	279.983	7984.507	0.00
150.0	904.545	6977.178	75.58	850.0	281.546	7988.072	0.00
160.0	783.835	7106.905	73.43	850.0	283.126	7991.608	0.00
170.0	689.009	7204.776	70.55	870.0	284.724	7995.117	0.00
180.0	618.298	7281.476	67.00	880.0	285.337	7998.598	0.00
190.0	562.356	7343.381	62.80	890.0	287.966	8002.053	0.00
200.0	517.138	7394.549	57.92	900.0	289.609	8005.483	0.00
210.0	479.954	7437.652	52.26	910.0	291.266	8008.889	0.00
220.0	448.942	7474.585	45.64	920.0	292.936	8012.270	0.00
230.0	422.777	7506.645	37.66	930.0	294.619	8015.629	0.00
240.0	400.487	7534.815	27.24	940.0	296.313	8018.964	0.00
250.0	381.341	7559.826	7.75	950.0	298.019	8022.278	0.00
260.0	364.783	7582.233	0.00	960.0	299.735	8025.571	0.00
270.0	350.381	7602.470	0.00	970.0	301.462	8028.843	0.00
280.0	337.793	7620.889	0.00	980.0	303.198	8032.096	0.00
290.0	326.744	7637.736	0.00	990.0	304.943	8035.328	0.00
300.0	317.015	7653.258	0.00	1000.0	306.696	8038.542	0.00
310.0	308.423	7667.629	0.00	1010.0	308.458	8041.736	0.00
320.0	300.820	7680.998	0.00	1020.0	310.227	8044.913	0.00
330.0	294.081	7693.489	0.00	1030.0	312.004	8048.072	0.00
340.0	288.102	7705.203	0.00	1040.0	313.787	8051.214	0.00
350.0	282.793	7716.242	0.00	1050.0	315.578	8054.339	0.00
360.0	278.080	7726.668	0.00	1060.0	317.374	8057.448	0.00
370.0	273.898	7736.549	0.00	1070.0	319.176	8060.540	0.00
380.0	270.192	7745.942	0.00	1080.0	320.983	8063.617	0.00
390.0	266.912	7754.895	0.00	1090.0	322.796	8066.679	0.00
400.0	264.017	7763.450	0.00	1100.0	324.613	8069.725	0.00
410.0	261.471	7771.644	0.00	1110.0	326.436	8072.757	0.00
420.0	259.241	7779.509	0.00	1120.0	328.262	8075.775	0.00
430.0	257.298	7787.074	0.00	1130.0	330.092	8078.778	0.00
440.0	255.617	7794.364	0.00	1140.0	331.926	8081.768	0.00
450.0	254.177	7801.402	0.00	1150.0	333.764	8084.744	0.00
460.0	252.956	7808.207	0.00	1160.0	335.605	8087.707	0.00
470.0	251.937	7814.798	0.00	1170.0	337.449	8090.657	0.00
480.0	251.104	7821.190	0.00	1180.0	339.295	8093.594	0.00
490.0	250.442	7827.399	0.00	1190.0	341.145	8096.519	0.00
500.0	249.938	7833.437	0.00	1200.0	342.996	8099.432	0.00
510.0	249.582	7839.316	0.00	1210.0	344.850	8102.332	0.00
520.0	249.351	7845.046	0.00	1220.0	346.703	8105.221	0.00
530.0	249.266	7850.639	0.00	1230.0	348.564	8108.098	0.00
540.0	249.289	7856.101	0.00	1240.0	350.424	8110.964	0.00
550.0	249.421	7861.443	0.00	1250.0	352.285	8113.818	0.00
560.0	249.654	7866.670	0.00	1260.0	354.147	8116.652	0.00
570.0	249.983	7871.791	0.00	1270.0	356.010	8119.495	0.00
580.0	250.401	7876.810	0.00	1280.0	357.875	8122.317	0.00
590.0	250.902	7881.735	0.00	1290.0	359.740	8125.128	0.00
600.0	251.480	7886.569	0.00	1300.0	361.607	8127.929	0.00
610.0	252.132	7891.319	0.00	1310.0	363.473	8130.720	0.00
620.0	252.852	7895.988	0.00	1320.0	365.341	8133.502	0.00
630.0	253.637	7900.581	0.00	1330.0	367.208	8136.273	0.00
640.0	254.482	7905.102	0.00	1340.0	369.076	8139.034	0.00
650.0	255.384	7909.554	0.00	1350.0	370.944	8141.787	0.00
660.0	256.339	7913.941	0.00	1360.0	372.813	8144.529	0.00
670.0	257.345	7918.266	0.00	1370.0	374.681	8147.263	0.00
680.0	258.399	7922.532	0.00	1380.0	376.548	8149.987	0.00
690.0	259.498	7926.741	0.00	1390.0	378.416	8152.702	0.00
700.0	260.639	7930.896	0.00	1400.0	380.283	8155.408	0.00
710.0	261.820	7934.999	0.00	1410.0	382.150	8158.106	0.00
720.0	263.039	7939.053	0.00	1420.0	384.016	8160.795	0.00
730.0	264.294	7943.050	0.00	1430.0	385.882	8163.475	0.00
740.0	265.582	7947.022	0.00	1440.0	387.747	8166.147	0.00
750.0	266.903	7950.940	0.00	1450.0	389.611	8168.811	0.00
760.0	268.254	7954.817	0.00	1460.0	391.474	8171.466	0.00
770.0	269.634	7958.653	0.00	1470.0	393.336	8174.113	0.00
780.0	271.042	7962.451	0.00	1480.0	395.197	8176.753	0.00
790.0	272.475	7966.212	0.00	1490.0	397.057	8179.384	0.00
800.0	273.932	7969.937	0.00	1500.0	398.916	8182.007	0.00

## Угол входа — 3,8 град

Н, мм	DVT, м/с	VBX, м/с	ТЕТА, ГРАД	Н, мм	DVT, м/с	VBX, м/с	ТЕТА, ГРАД
110.0	2814.219	5042.523	68.43	810.0	279.701	7969.772	0.00
120.0	1890.933	6002.556	74.72	820.0	281.150	7973.484	0.00
130.0	1399.709	6470.124	76.67	830.0	282.622	7977.162	0.00
140.0	1126.098	6749.917	76.72	840.0	284.114	7980.837	0.00
150.0	945.017	6937.101	75.61	850.0	285.627	7984.422	0.00
160.0	816.551	7071.623	73.64	850.0	287.159	7988.005	0.00
170.0	720.907	7173.287	70.95	870.0	288.710	7991.562	0.00
180.0	647.130	7253.057	67.63	880.0	290.277	7995.089	0.00
190.0	588.658	7317.498	63.69	890.0	291.861	7998.589	0.00
200.0	541.320	7370.786	59.10	900.0	293.461	8002.052	0.00
210.0	502.332	7415.704	53.81	910.0	295.075	8005.510	0.00
220.0	469.770	7454.179	47.67	920.0	295.704	8008.933	0.00
230.0	442.257	7487.589	40.38	930.0	298.346	8012.332	0.00
240.0	418.784	7516.943	31.25	940.0	300.000	8015.708	0.00
250.0	398.593	7543.009	17.76	950.0	301.667	8019.060	0.00
260.0	381.104	7566.339	0.00	960.0	303.345	8022.391	0.00
270.0	365.868	7587.412	0.00	970.0	305.035	8025.700	0.00
280.0	352.528	7606.574	0.00	980.0	306.734	8028.988	0.00
290.0	340.799	7624.111	0.00	990.0	308.444	8332.256	0.00
300.0	330.450	7640.253	0.00	1000.0	310.163	8035.504	0.00
310.0	321.292	7655.191	0.00	1010.0	311.890	8038.733	0.00
320.0	313.170	7669.079	0.00	1020.0	313.626	8041.943	0.00
330.0	305.953	7682.049	0.00	1030.0	315.371	8045.135	0.00
340.0	299.532	7694.210	0.00	1040.0	317.122	8048.308	0.00
350.0	293.814	7705.653	0.00	1050.0	318.881	8051.464	0.00
360.0	288.721	7716.459	0.00	1060.0	320.647	8054.603	0.00
370.0	284.185	7726.695	0.00	1070.0	322.419	8057.726	0.00
380.0	280.148	7736.419	0.00	1080.0	324.197	8060.832	0.00
390.0	276.559	7745.681	0.00	1090.0	325.981	8063.922	0.00
400.0	273.374	7754.526	0.00	1100.0	327.770	8066.997	0.00
410.0	270.555	7762.993	0.00	1110.0	329.564	8070.056	0.00
420.0	268.099	7771.115	0.00	1120.0	331.363	8073.101	0.00
430.0	265.894	7778.922	0.00	1130.0	333.167	8076.131	0.00
440.0	263.974	7786.441	0.00	1140.0	334.975	8079.147	0.00
450.0	262.317	7793.695	0.00	1150.0	336.787	8082.148	0.00
460.0	260.891	7800.705	0.00	1160.0	338.603	8085.136	0.00
470.0	259.678	7807.491	0.00	1170.0	340.422	8088.111	0.00
480.0	258.659	7814.068	0.00	1180.0	342.244	8091.072	0.00
490.0	257.822	7820.453	0.00	1190.0	344.070	8094.021	0.00
500.0	257.151	7826.658	0.00	1200.0	345.898	8096.957	0.00
510.0	256.634	7832.697	0.00	1210.0	347.729	8099.880	0.00
520.0	256.261	7838.580	0.00	1220.0	349.562	8102.791	0.00
530.0	256.020	7844.319	0.00	1230.0	351.398	8105.691	0.00
540.0	255.933	7849.921	0.00	1240.0	353.235	8108.578	0.00
550.0	255.902	7855.396	0.00	1250.0	355.075	8111.454	0.00
560.0	256.007	7860.751	0.00	1260.0	356.916	8114.318	0.00
570.0	256.213	7865.995	0.00	1270.0	358.759	8117.172	0.00
580.0	256.513	7871.132	0.00	1280.0	360.603	8120.014	0.00
590.0	256.900	7876.170	0.00	1290.0	362.448	8122.845	0.00
600.0	257.370	7881.113	0.00	1300.0	364.294	8125.666	0.00
610.0	257.917	7885.968	0.00	1310.0	366.142	8128.477	0.00
620.0	258.536	7890.738	0.00	1320.0	367.990	8131.277	0.00
630.0	259.223	7895.429	0.00	1330.0	369.839	8134.067	0.00
640.0	259.974	7900.043	0.00	1340.0	371.688	8136.847	0.00
650.0	260.785	7904.586	0.00	1350.0	373.538	8139.617	0.00
660.0	261.653	7909.061	0.00	1360.0	375.388	8142.377	0.00
670.0	262.575	7913.470	0.00	1370.0	377.239	8145.128	0.00
680.0	263.547	7917.817	0.00	1380.0	379.089	8147.870	0.00
690.0	264.566	7922.105	0.00	1390.0	380.939	8150.602	0.00
700.0	265.631	7926.337	0.00	1400.0	382.790	8153.325	0.00
710.0	266.738	7930.514	0.00	1410.0	384.640	8156.039	0.00
720.0	267.885	7934.640	0.00	1420.0	386.490	8158.744	0.00
730.0	269.070	7938.716	0.00	1430.0	388.339	8161.441	0.00
740.0	270.291	7942.745	0.00	1440.0	390.188	8164.128	0.00
750.0	271.547	7946.729	0.00	1450.0	392.036	8166.808	0.00
760.0	272.834	7950.669	0.00	1460.0	393.884	8169.478	0.00
770.0	274.153	7954.567	0.00	1470.0	395.731	8172.141	0.00
780.0	275.500	7958.425	0.00	1480.0	397.577	8174.795	0.00
790.0	276.874	7962.244	0.00	1490.0	399.422	8177.441	0.00
800.0	278.275	7966.026	0.00	1500.0	401.266	8180.079	0.00

Угол входа — 3,9 град

Н, мм	DVT, м/с	VBX, м/с	ТETA, ГРАД	Н, мм	DVT, м/с	VBX, м/с	ТETA, ГРАД
110.0	2891.516	4965.520	67.83	810.0	284.096	7965.820	0.00
120.0	1926.564	5937.285	74.27	820.0	285.491	7969.586	0.00
130.0	1454.707	6415.503	76.37	830.0	286.909	7973.317	0.00
140.0	1173.042	6703.366	76.57	840.0	288.349	7977.015	0.00
150.0	985.850	6896.672	75.61	850.0	289.812	7980.680	0.00
160.0	852.639	7035.946	73.81	860.0	291.294	7984.314	0.00
170.0	753.222	7141.390	71.31	870.0	292.796	7987.918	0.00
180.0	676.380	7224.229	68.20	880.0	294.317	7991.492	0.00
190.0	615.373	7291.208	64.49	890.0	295.855	7995.037	0.00
200.0	565.904	7346.630	60.18	900.0	297.410	7998.555	0.00
210.0	525.102	7393.365	55.21	910.0	298.980	8002.047	0.00
220.0	490.976	7433.406	49.49	920.0	300.566	8005.512	0.00
230.0	462.102	7468.179	42.78	930.0	302.167	8008.953	0.00
240.0	437.433	7498.729	34.60	940.0	303.781	8012.369	0.00
250.0	416.185	7525.845	23.58	950.0	305.408	8015.761	0.00
260.0	397.754	7550.128	0.00	960.0	307.047	8019.131	0.00
270.0	381.672	7572.046	0.00	970.0	308.698	8022.478	0.00
280.0	367.570	7591.971	0.00	980.0	310.361	8025.803	0.00
290.0	355.150	7610.200	0.00	990.0	312.034	8029.107	0.00
300.0	344.172	7626.972	0.00	1000.0	313.717	8032.390	0.00
310.0	334.439	7642.485	0.00	1010.0	315.410	8035.654	0.00
320.0	325.789	7656.902	0.00	1020.0	317.112	8038.898	0.00
330.0	318.085	7670.369	0.00	1030.0	318.823	8042.122	0.00
340.0	311.216	7682.969	0.00	1040.0	320.542	8045.328	0.00
350.0	305.082	7694.829	0.00	1050.0	322.269	8048.516	0.00
360.0	299.602	7706.022	0.00	1060.0	324.003	8051.687	0.00
370.0	294.705	7716.618	0.00	1070.0	325.744	8054.840	0.00
380.0	290.332	7726.679	0.00	1080.0	327.492	8057.976	0.00
390.0	286.427	7736.257	0.00	1090.0	329.247	8061.096	0.00
400.0	282.947	7745.398	0.00	1100.0	331.007	8064.199	0.00
410.0	279.850	7754.143	0.00	1110.0	332.773	8067.287	0.00
420.0	277.102	7762.527	0.00	1120.0	334.544	8070.359	0.00
430.0	274.670	7770.581	0.00	1130.0	336.321	8073.416	0.00
440.0	272.527	7778.333	0.00	1140.0	338.102	8076.458	0.00
450.0	270.649	7785.808	0.00	1150.0	339.887	8079.486	0.00
460.0	269.014	7793.027	0.00	1160.0	341.677	8082.500	0.00
470.0	267.602	7800.011	0.00	1170.0	343.471	8085.500	0.00
480.0	266.395	7806.778	0.00	1180.0	345.269	8088.486	0.00
490.0	265.378	7813.342	0.00	1190.0	347.070	8091.459	0.00
500.0	264.536	7819.718	0.00	1200.0	348.874	8094.419	0.00
510.0	263.856	7825.920	0.00	1210.0	350.681	8097.365	0.00
520.0	263.327	7831.950	0.00	1220.0	352.491	8100.300	0.00
530.0	262.937	7837.847	0.00	1230.0	354.304	8103.221	0.00
540.0	262.678	7843.592	0.00	1240.0	356.119	8106.131	0.00
550.0	262.539	7849.203	0.00	1250.0	357.937	8109.029	0.00
560.0	262.514	7854.689	0.00	1260.0	359.756	8111.915	0.00
570.0	262.595	7860.058	0.00	1270.0	361.578	8114.789	0.00
580.0	262.774	7865.316	0.00	1280.0	363.401	8117.652	0.00
590.0	263.045	7870.470	0.00	1290.0	365.226	8120.504	0.00
600.0	263.404	7875.525	0.00	1300.0	367.052	8123.315	0.00
610.0	263.843	7880.485	0.00	1310.0	368.879	8126.176	0.00
620.0	264.359	7885.360	0.00	1320.0	370.708	8128.995	0.00
630.0	264.945	7890.150	0.00	1330.0	372.537	8131.804	0.00
640.0	265.602	7894.850	0.00	1340.0	374.368	8134.603	0.00
650.0	266.320	7899.496	0.00	1350.0	376.199	8137.392	0.00
660.0	267.099	7904.060	0.00	1360.0	378.030	8140.170	0.00
670.0	267.934	7908.555	0.00	1370.0	379.863	8142.939	0.00
680.0	268.822	7912.985	0.00	1380.0	381.695	8145.699	0.00
690.0	269.761	7917.355	0.00	1390.0	383.528	8148.448	0.00
700.0	270.747	7921.665	0.00	1400.0	385.361	8151.188	0.00
710.0	271.778	7925.918	0.00	1410.0	387.194	8153.919	0.00
720.0	272.852	7930.117	0.00	1420.0	389.027	8156.641	0.00
730.0	273.966	7934.265	0.00	1430.0	390.860	8159.354	0.00
740.0	275.118	7938.363	0.00	1440.0	392.692	8162.058	0.00
750.0	276.306	7942.413	0.00	1450.0	394.525	8164.753	0.00
760.0	277.529	7946.418	0.00	1460.0	396.356	8167.439	0.00
770.0	278.784	7950.380	0.00	1470.0	398.188	8170.117	0.00
780.0	280.069	7954.299	0.00	1480.0	400.018	8172.787	0.00
790.0	281.384	7958.178	0.00	1490.0	401.848	8175.448	0.00
800.0	282.727	7962.018	0.00	1500.0	403.677	8178.101	0.00

## Угол входа — 4,0 град

Н, км	DVT, м/с	VBX, м/с	ТЕТА, ГРАД	Н, км	DVT, м/с	VBX, м/с	ТЕТА, ГРАД
110.0	2967.249	4890.083	67.25	710.0	276.940	7921.211	0.00
120.0	1991.720	5872.484	73.82	720.0	277.939	7925.485	0.00
130.0	1509.708	6360.885	76.06	730.0	278.980	7929.705	0.00
140.0	1220.208	6656.601	76.40	740.0	280.061	7933.875	0.00
150.0	1027.009	6855.926	75.59	750.0	281.181	7937.994	0.00
160.0	889.101	6999.904	73.95	760.0	282.337	7942.065	0.00
170.0	785.931	7109.107	71.62	770.0	283.527	7946.091	0.00
180.0	706.030	7195.010	68.70	780.0	284.750	7950.073	0.00
190.0	642.484	7264.533	65.21	790.0	285.004	7954.012	0.00
200.0	590.877	7322.095	61.14	800.0	287.283	7957.912	0.00
210.0	548.250	7370.658	56.48	810.0	288.599	7961.771	0.00
220.0	512.549	7412.276	51.12	820.0	289.937	7955.594	0.00
230.0	482.302	7448.423	44.90	830.0	291.301	7959.380	0.00
240.0	456.427	7480.182	37.47	840.0	292.688	7973.131	0.00
250.0	434.109	7508.368	27.97	850.0	294.098	7976.848	0.00
260.0	414.724	7533.606	12.46	860.0	295.530	7980.532	0.00
270.0	397.787	7556.381	0.00	870.0	293.983	7984.184	0.00
280.0	382.912	7577.079	0.00	880.0	298.455	7987.806	0.00
290.0	369.792	7596.009	0.00	890.0	299.947	7991.399	0.00
300.0	358.175	7613.420	0.00	900.0	301.456	7994.963	0.00
310.0	347.859	7629.518	0.00	910.0	302.982	7998.499	0.00
320.0	338.673	7644.471	0.00	920.0	304.524	8002.008	0.00
330.0	330.476	7658.422	0.00	930.0	306.082	8005.491	0.00
340.0	323.149	7671.488	0.00	940.0	307.654	8008.948	0.00
350.0	316.592	7683.772	0.00	950.0	309.241	8012.381	0.00
360.0	310.719	7695.359	0.00	960.0	310.840	8015.790	0.00
370.0	305.456	7706.322	0.00	970.0	312.453	8019.176	0.00
380.0	300.739	7716.726	0.00	980.0	314.077	8022.539	0.00
390.0	296.514	7726.625	0.00	990.0	315.713	8025.880	0.00
400.0	292.733	7736.067	0.00	1000.0	317.360	8029.200	0.00
410.0	289.353	7745.095	0.00	1010.0	319.017	8032.499	0.00
420.0	285.338	7753.745	0.00	1020.0	320.684	8035.777	0.00
430.0	283.655	7762.052	0.00	1030.0	322.361	8039.036	0.00
440.0	281.274	7770.042	0.00	1040.0	324.047	8042.275	0.00
450.0	279.171	7777.742	0.00	1050.0	325.741	8045.496	0.00
460.0	277.323	7785.175	0.00	1060.0	327.443	8048.698	0.00
470.0	275.708	7792.331	0.00	1070.0	329.153	8051.882	0.00
480.0	274.309	7799.320	0.00	1080.0	330.870	8055.049	0.00
490.0	273.108	7806.067	0.00	1090.0	332.594	8058.199	0.00
500.0	272.092	7812.619	0.00	1100.0	334.325	8061.332	0.00
510.0	271.243	7818.987	0.00	1110.0	336.062	8064.448	0.00
520.0	270.557	7825.185	0.00	1120.0	337.804	8067.549	0.00
530.0	270.019	7831.224	0.00	1130.0	339.553	8070.634	0.00
540.0	269.611	7837.115	0.00	1140.0	341.306	8073.704	0.00
550.0	269.333	7842.866	0.00	1150.0	343.065	8076.758	0.00
560.0	269.175	7848.486	0.00	1160.0	344.829	8079.798	0.00
570.0	269.127	7853.982	0.00	1170.0	346.595	8082.824	0.00
580.0	269.183	7859.363	0.00	1180.0	348.368	8085.835	0.00
590.0	269.336	7864.635	0.00	1190.0	350.144	8088.833	0.00
600.0	269.580	7869.804	0.00	1200.0	351.924	8091.817	0.00
610.0	269.910	7874.875	0.00	1210.0	353.707	8094.788	0.00
620.0	270.321	7879.854	0.00	1220.0	355.494	8097.746	0.00
630.0	270.807	7884.746	0.00	1230.0	357.283	8100.691	0.00
640.0	271.364	7889.554	0.00	1240.0	359.075	8103.623	0.00
650.0	271.988	7894.284	0.00	1250.0	360.870	8106.544	0.00
660.0	272.675	7898.940	0.00	1260.0	362.668	8109.452	0.00
670.0	273.421	7903.524	0.00	1270.0	364.467	8112.348	0.00
680.0	274.224	7908.040	0.00	1280.0	366.269	8115.232	0.00
690.0	275.080	7912.491	0.00	1290.0	368.073	8118.105	0.00
700.0	275.986	7916.881	0.00	1300.0	369.878	8120.966	0.00



## Угол входа — 4,0 град

<i>H</i> , км	<i>DVT</i> , м/с	<i>VBX</i> , м/с	<i>TETA</i> , ГРАД	<i>H</i> , км	<i>DVT</i> , м/с	<i>VBX</i> , м/с	<i>TETA</i> , ГРАД
1310.0	371.685	8123.817	0.00	1410.0	389.812	8151.747	0.00
1320.0	373.493	8126.656	0.00	1420.0	391.628	8154.486	0.00
1330.0	375.303	8129.485	0.00	1430.0	393.444	8157.215	0.00
1340.0	377.114	8132.303	0.00	1440.0	395.260	8159.936	0.00
1350.0	378.926	8135.111	0.00	1450.0	397.076	8162.647	0.00
1360.0	380.739	8137.908	0.00	1460.0	398.891	8165.349	0.00
1370.0	382.553	8140.696	0.00	1470.0	400.706	8168.043	0.00
1380.0	384.367	8143.473	0.00	1480.0	402.521	8170.728	0.00
1390.0	386.182	8146.241	0.00	1490.0	404.336	8173.405	0.00
1400.0	387.997	8148.998	0.00	1500.0	406.149	8176.073	0.00

Примечание к табл. 9—47. В таблицах приняты следующие обозначения:

*H* — высота орбиты;

*VBX* — скорость ИСЗ на границе атмосферы ( $V_{вх}$ );

*DVT* — величина импульса скорости ( $\Delta V_T$ );

*TETA* — угол ориентации импульса скорости ( $V_T$ ).

## МЕТОДИКА РАСЧЕТА АЭРОДИНАМИЧЕСКИХ КОЭФФИЦИЕНТОВ ИСЗ

## 1. ОСНОВНЫЕ ПОЛОЖЕНИЯ

1.1. Программа предназначена для расчета методом статистических испытаний (метод Монте—Карло) аэродинамических коэффициентов ИСЗ сложной формы при полете его в сильно разреженных слоях верхней атмосферы.

1.2. Программа изложена на языке Фортран и предназначена для работы на ЭВМ БЭСМ-6 с дисковой операционной системой ДИСПАК в рамках мониторингной системы «Дубна».

1.3. Для работы программы в паспорте программы необходимо заказать 37 листов оперативного запоминающего устройства и 64 тракта магнитного барабана. Ввод информации осуществляют с перфокарт. Результаты расчета выводят на автоматическое цифровое печатающее устройство.

1.4. Задачу решают при следующих предположениях:  
набегающий поток газа является многокомпонентной смесью из атомов и молекул, скорости которых распределены по закону Максвелла;

режим обтекания поверхности ИСЗ разреженным газом верхней атмосферы — свободномолекулярный; молекулы набегающего потока газа испытывают многократные столкновения с вогнутой поверхностью ИСЗ; обмен импульсом и энергией при столкновении молекул с поверхностью ИСЗ характеризуется коэффициентами accommodation: энергии  $\sigma_e$ , нормального  $\sigma_n$  и тангенциального  $\sigma_t$  импульсов с учетом их зависимости от энергии и угла столкновения молекул с поверхностью ИСЗ.

Отражение молекул от поверхности ИСЗ происходит по четырем законам:

- зеркальному;
- зеркально-диффузному;
- в соответствии с функцией распределения Максвелла;
- в соответствии с лучевой моделью.

1.5. По программе рассчитывают также аэродинамические коэффициенты сложного тела в потоке света, в гиперзвуковом потоке невязкого газа в соответствии с теорией Ньютона, в переходной области в соответствии с гипотезой локальности и частные производные аэродинамических коэффициентов по безразмерной угловой скорости.

1.6. Формулы расчета аэродинамических коэффициентов сил и моментов, действующих на ИСЗ, и безразмерных угловых скоростей приведены в табл. 1.

Таблица 1

Коэффициент	Формула расчета
1. Коэффициент аэродинамической продольной силы	$C_x = \frac{X}{qS_M}$
2. Коэффициент аэродинамической нормальной силы	$C_y = \frac{Y}{qS_M}$
3. Коэффициент аэродинамической поперечной силы	$C_z = \frac{Z}{qS_M}$
4. Коэффициент лобового сопротивления	$C_{x\alpha} = \frac{X_\alpha}{qS_M}$
5. Коэффициент аэродинамической подъемной силы	$C_{y\alpha} = \frac{Y_\alpha}{qS_M}$
6. Коэффициент аэродинамической боковой силы	$C_{z\alpha} = \frac{Z_\alpha}{qS_M}$
7. Коэффициент аэродинамического момента крена	$m_x = \frac{M_x}{qS_M D_M}$
8. Коэффициент аэродинамического момента рыскания	$m_y = \frac{M_y}{qS_M D_M}$
9. Коэффициент аэродинамического момента тангажа	$m_z = \frac{M_z}{qS_M D_M}$
10. Коэффициент аэродинамического момента крена в скоростной системе координат	$m_{x\alpha} = \frac{M_{x\alpha}}{qS_M D_M}$
11. Коэффициент аэродинамического момента рыскания в скоростной системе координат	$m_{y\alpha} = \frac{m_{y\alpha}}{qS_M D_M}$

Коэффициент	Формула расчета
12. Коэффициент аэродинамического момента тангажа в скоростной системе координат	$m_{2a} = \frac{M_{2a}}{q S_M D_M}$
13. Безразмерная угловая скорость крена	$\bar{\omega}_x = \omega_x \frac{D_M}{V_\infty}$
14. Безразмерная угловая скорость рыскания	$\bar{\omega}_y = \omega_y \frac{D_M}{V_\infty}$
15. Безразмерная угловая скорость тангажа	$\bar{\omega}_z = \omega_z \frac{D_M}{V_\infty}$

1.7. Для обозначения частных производных коэффициентов сил и моментов устанавливают обозначения вида  $A^i$ , где  $A$  — символ рассматриваемого коэффициента силы или момента,  $i$  — символ величины, по которой берется производная. Например,  $m_{2a}^{\omega_x}$  — частная производная коэффициента момента тангажа по безразмерной угловой скорости тангажа.

## 2. ОПИСАНИЕ АЛГОРИТМА

2.1. Геометрию поверхности ИСЗ задают в связанной системе координат  $Xx_i$  ( $i=1, 2, 3$ ). Оси  $Xx_1, Xx_2, Xx_3$  соответствуют связанным осям  $OX, OY, OZ$  (ГОСТ 20058—80). Расположение точки  $X$  — начало системы координат и направление связанных осей  $x_i$  выбирают произвольно с учетом удобства задания информации о поверхности ИСЗ.

2.2. Поверхность ИСЗ условно разбивают на  $N$  поверхностей второго порядка или их характерных комбинаций: шестигранная поверхность (черт. 1); эллиптическое кольцо (черт. 2); поверхность эллиптического цилиндра (черт. 3); поверхность эллиптического конуса (черт. 4); поверхность эллиптического параболоида (черт. 5); поверхность трехосного эллипсоида (черт. 6); поверхность тела вращения (черт. 7); поверхность второго порядка.

Положение и размеры для поверхностей (см. черт. 1—6) относительно связанной системы координат  $Xx_i$  задают координатами  $T_{1i}, T_{2i}$  и  $T_{3i}$  трех характерных точек  $T_1, T_2$  и  $T_3$ , для поверхности тела вращения (см. черт. 7) — координатами  $T_{4i}$  точки  $T_4$ , направляющими косинусами  $C_{1i}$  оси  $Y_i$ , для поверхности второго порядка — коэффициентами  $B_{1i}, B_{2i}, B_{3i}, B_{4i}, B_{5i}, B_{6i}, B_{7i}, B_{8i}, B_{9i}$  уравнения поверхности

$$B_{1i}y_1^2 + B_{2i}y_2^2 + B_{3i}y_3^2 + 2B_{4i}y_1y_2 + 2B_{5i}y_2y_3 + 2B_{6i}y_1y_3 + 2B_{7i}y_1 + 2B_{8i}y_2 + 2B_{9i}y_3 + B_{10i} = 0 \quad (1)$$

относительно произвольно расположенной прямоугольной системы координат  $Yy_j$  ( $j=1, 2, 3$ ), ориентированной координатами  $x_{0i}$  точки  $Y$  и направляющими косинусами  $a_{1i}$  оси  $y_1$  и  $a_{2i}$  оси  $y_2$  относительно системы координат  $Xx_i$  и параметров, приведенными в табл. 2.

2.2.1. На черт. 1 плоскость симметрии  $T_1T_2T_3$  перпендикулярна параллельным граням  $T_5T_6T_{10}T_9$  и  $T_7T_8T_{12}T_{11}$ , представляющими прямоугольники, и граням  $T_5T_7T_{11}T_4$  и  $T_6T_8T_{12}T_6$ , которые представляют: треугольники ( $H_1=0$ ), трапеции ( $H_1>0, H_1<H_2$ ) и прямоугольники ( $H_1=H_2$ ).

При  $H_1=H_2=0$  шестигранная поверхность преобразуется в треугольник ( $H_3=0$ ), трапецию ( $H_3>0, H_3<T_1T_2$ ) или параллелограмм ( $H_3=T_1T_2$ ).

2.2.2. На черт. 2 эллиптическое кольцо представляет плоскую поверхность, ограниченную двумя подобными эллипсами 1 и 2, оси которых  $T_1T_2$  и  $T_1T_3$  совпадают.

2.2.3. Для эллиптических цилиндра, конуса и параболоида (см. черт. 3—5), кроме боковой поверхности 1, допускается учитывать основания 2 и 3, которые в общем случае представляют эллипсы с осями  $T_1T_2, T_1T_3, T_4T_5, T_4T_6$ , причем  $T_1T_2 \parallel T_4T_5, T_1T_3 \parallel T_4T_6$ , а ось  $T_1T_4$ , расположенная в плоскости симметрии  $y_1y_2$ , в общем случае не перпендикулярна основаниям.

2.2.4. Оси эллипсоида (см. черт. 6) равны  $T_1T_2, T_1T_3$  и  $H_1$ .

2.2.5. Ось  $y_3$  на черт. 3—6 перпендикулярна плоскости  $T_2T_1T_3$ .

2.2.6. На черт. 3—5  $H_2>0$ , если угол между прямыми  $T_1T_2$  и  $T_1T_4$   $e \leq 90^\circ$  и  $H_2 < 0$ , если  $90^\circ < e < 180^\circ$ .

2.2.7. На черт. 2—6 линиями штриховки показаны области, которые «вырезаются» из поверхностей и границы которых определяются заданными углами долготы  $F_1, F_2$  и широты  $\Theta_1, \Theta_2$ . В расчете учитываются только «вырезанные» области.

2.2.8. Образующая поверхности тела вращения (см. черт. 7) представляет произвольную непрерывную ломаную линию с вершинами в точках  $T_1, T_2, T_3, \dots, T_N$ , координаты которых ( $T_{1i}, T_{2i}$ ) точки  $T_1, (T_{2i}, T_{2i})$  точки  $T_2$  и т. д. вдоль осей  $y_1$  и  $y_2$  соответственно задают в системе координат  $T_4y_1y_2$ .

2.2.9. Расположение выбранных точек  $T_1, T_2$  и  $T_3$  должно быть таким, чтобы поворот от точки  $T_2$  к точке  $T_3$  относительно точки  $T_1$  при наблюдении с конца внешней нормали или со стороны задаваемой поверхности был против часовой стрелки.

2.2.10. Значения углов  $F_1$  и  $F_2$  на черт. 3—5, отсчитываемых от плоскости симметрии  $y_1y_2$  вокруг произвольных точек осей  $T_1T_4$  в любых плоских сечениях, параллельных плоскости основания, для «вырезанной» области поверхности, остаются постоянными.

2.2.11. Для каждой типовой поверхности ИСЗ задают признаки  $P_1$  и  $P_2$ :

$P_1$  — тип поверхности;

$P_2$  — количество учитываемых поверхностей второго порядка.

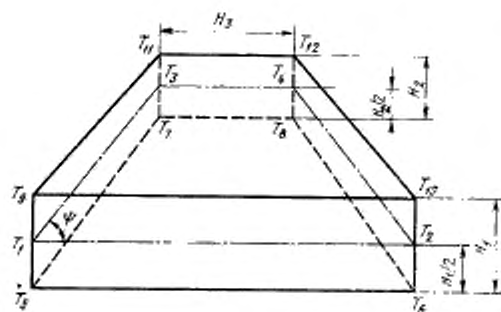

Черт. 1

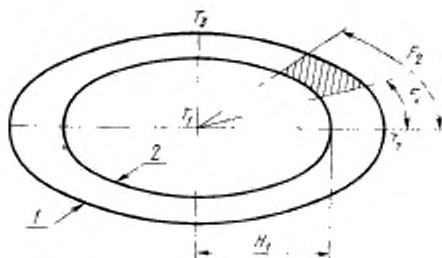

Черт. 2

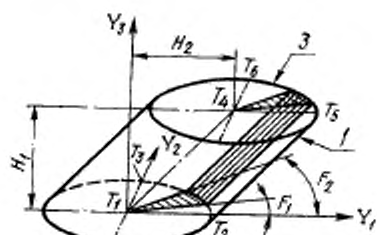

Черт. 3

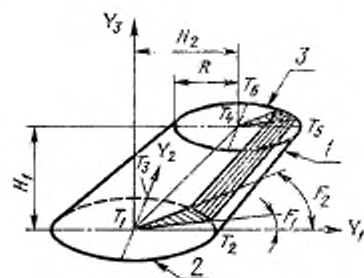

Черт. 4

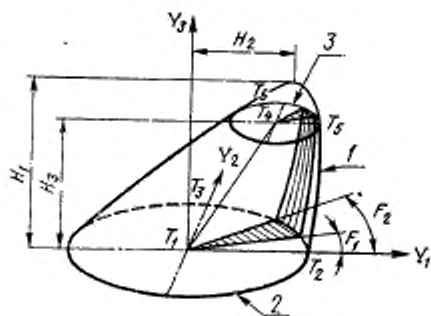

Черт. 5

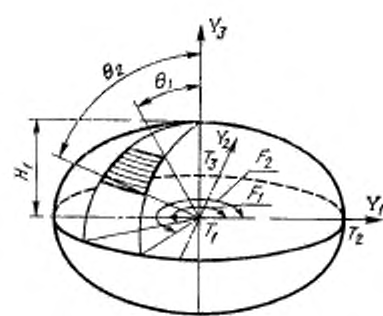

Черт. 6

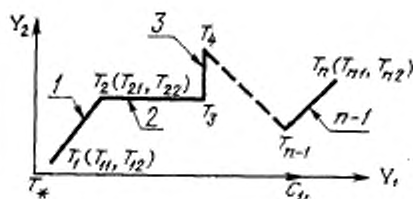

Черт. 7

Таблица 2

Наименование типовых поверхностей ИСЗ	Информация о поверхности для ЭВМ		Требования к параметрам	
	Параметр	Признак		
		$P_1$		$P_2$
Шестигранная поверхность	$T_{1i}, T_{2i}, T_{3i}, H_3, H_1, H_2$	1	1	$T_1, T_3 \geq H_3$ $H_1 > H_2$ $\psi < \pi/2$
		1	2	
		1	3	
		1	4	
Эллиптическое кольцо	$T_{1i}, T_{2i}, T_{3i}, H_1, F_1, F_2$	2	1	$F_1 \in [0, 360^\circ]$ $F_2 \in [F_1, F_1 + 360^\circ]$
Эллиптический цилиндр	$T_{1i}, T_{2i}, T_{3i}, H_1, H_2, F_1, F_2$	3	1	$F_1 \in [0, 360^\circ]$ $F_2 \in [F_1, F_1 + 360^\circ]$
		3	2	
		3	3	
		3	4	
Эллиптический конус	$T_{1i}, T_{2i}, T_{3i}, H_1, H_2, R, F_1, F_2$	4	1	$F_1 \in [0, 360^\circ]$ $F_2 \in [F_1, F_1 + 360^\circ]$
		4	2	
		4	3	
		4	4	
Эллиптический параболоид	$T_{1i}, T_{2i}, T_{3i}, H_1, H_2, F_1, F_2, H_3$	5	1	$F_1 \in [0, 360^\circ]$ $F_2 \in [F_1, F_1 + 360^\circ]$ $0 < H_3 < H_1$
		5	2	
		5	3	
		5	4	
Трехосный эллипсоид	$T_{1i}, T_{2i}, T_{3i}, H_1, F_1, F_2, \theta_1, \theta_2$	6	1	$F_1 \in [0, 360^\circ]; F_2 \in [F_1, F_1 + 360^\circ]$ $\theta_1 \in [0, 180^\circ]; \theta_2 \in [\theta_1, 180^\circ]$
Тело вращения	$T_{1i}, C_{1i}, T_{11}, T_{12}, T_{21}, T_{22}, T_{31}, T_{32}, \dots, T_{ni}, T_{ni}$	7	$n$	$n < 51$
Поверхность второго порядка	$B_{11}, B_{21}, B_{31}, B_{12}, B_{22}, B_{32}, B_{14}, B_{24}, B_{34}, B_{44}, x_{0i}, a_{1i}, a_{2i}, \beta_1, \beta_2, \gamma_1, \gamma_2, P$	8	1	

2.2.11.1. Для шестигранной поверхности при значении  $P_2=1$  учитываются все шесть граней, при  $P_2=2$  не учитывается грань  $T_7T_8T_{12}T_{11}$ , при  $P_2=3$  не учитывается грань  $T_5T_6T_{12}T_9$ , при  $P_2=4$  не учитываются грани  $T_1T_3T_{10}T_7$  и  $T_7T_8T_{12}T_{11}$ .

2.2.11.2. Для поверхностей (см. черт. 3—5) при значении  $P_2=1$  учитываются все поверхности 1—3, при  $P_2=2$  учитываются поверхности 1 и 2, при  $P_2=3$  учитываются поверхности 1 и 3, при  $P_2=4$  учитывается только поверхность 1.

2.2.11.3. Для поверхности тела вращения (см. черт. 7) значение  $P_2=n$  (количество вершин ломаной линии — образующей тела вращения).

2.2.12. Требования к значениям параметров для типовых поверхностей приведены в табл. 2.

2.3. Типовые поверхности ИСЗ, приведенные на черт. 1, 3—5, 7 являются комбинацией поверхностей второго порядка: параллелограмма, трапеции, эллиптического кольца, боковых поверхностей цилиндра, конуса, параболоида и эллипсоида.



2.4. Подпрограмма *TELA* обрабатывает информацию о типовых поверхностях и готовит соответствующие массивы информации обо всех поверхностях второго порядка ИСЗ.

2.5. Уравнение поверхности второго порядка относительно осей  $Xx_i$  имеет вид

$$A_{ik}x_ix_k + 2A_ix_i + A_{44} = 0, \quad (i, k=1, 2, 3), \quad (2)$$

где  $A_{ik}$ ,  $A_i$ ,  $A_{44}$  — коэффициенты уравнения второго порядка, вычисляемые по значениям параметров, приведенных в табл. 2.

2.6. Границы области  $D$  поверхности второго порядка рассчитывают в системе координат  $Yy_j$ , ориентированной относительно системы координат  $Xx_i$  направляющими косинусами  $a_{ij}$  углов между осями  $x_i$  и  $y_j$  и координатами  $x_{0i}$  точки  $Y$ .

2.6.1. Для задания области  $D$  используют:

в прямоугольной системе координат ( $y_j$ ) — переменные ( $y_1, y_2$ );

в полярной системе ( $\varphi, r, y_3$ ) — переменные ( $\varphi, r$ );

в цилиндрической системе ( $\varphi, r, y_3$ ) — переменные ( $\varphi, y_3$ );

в сферической системе ( $\varphi, \theta, r$ ) — переменные ( $\varphi, \theta$ ).

В указанных системах координат почти для всех поверхностей второго порядка ИСЗ, встречающихся в практике, форма области  $D$  простейшая: прямоугольная с пределами  $\varphi_1$  и  $\varphi_2$  по внешней переменной ( $y_1$  и  $\varphi$ ) и с пределами  $\tau_1$  и  $\tau_2$  по внутренней переменной ( $y_2, r, y_3$  и  $\theta$ ).

2.6.2. Для обозначения систем координат вводят признак  $P$ , равный:

1 — для прямоугольной;

2 — для цилиндрической;

3 — для полярной;

4 — для сферической.

При  $P=1$  и  $P=3$  в расчетах учитывают только те участки поверхности, для которых  $y_2 > 0$ , при  $P=2$  задают  $\tau_1=0$ .

2.7. На поверхностях второго порядка могут быть области исключения, имеющие сложную границу. Области исключения задают в соответствии с п. 2.2.

2.7.1. Для задания области исключения используют два массива:

*NPD* — массив, элементы которого равны номерам областей исключения;

*MD2* — массив, порядок расположения элементов которого соответствует расположению элементов *NPD*, а значения равны номерам поверхностей второго порядка, к которым принадлежит область исключения.

Границы областей исключения данной поверхности могут быть односвязными, многосвязными, пересекаться друг с другом и с границей поверхности.

2.8. Все поверхности второго порядка могут быть пористыми. Коэффициент пористости *MD1* — часть молекул газа, проходящая через поверхность, не изменяя вектора скорости. Оставшаяся часть молекул газа ( $1-MD1$ ) отражается от поверхности, как от сплошной стенки.

2.9. Поверхность ИСЗ окружают условной контрольной поверхностью (КП), имеющей форму параллелепипеда.

2.10. Выбор случайных значений координат точки начала движения и компонент вектора скорости молекул набегающего потока газа производят методом Монте-Карло на поверхности КП с помощью функций распределения плотности вероятности.

2.11. Для поверхности второго порядка проводят анализ решения системы двух уравнений:

уравнения поверхности второго порядка по формуле (2) и уравнения первого порядка траектории движения молекулы газа по формуле

$$x_{i-\lambda} - x_{i-\lambda-1} + \xi_{-\lambda i}^{\lambda} t, \quad (3)$$

где  $x_{i-\lambda}$ ,  $\xi_{-\lambda i}^{\lambda}$  — координаты точки начала движения и проекции единичного вектора скорости молекулы газа;

$t$  — расстояние, пройденное молекулой газа;

$\lambda$  — индекс, значение которого равно номеру точки начала движения молекулы газа.

В результате решения определяют, столкнулась ли молекула с поверхностью или нет.

2.12. При зеркально-диффузном отражении молекулы газа с поверхности ИСЗ проводят выбор случайных значений параметров закона отражения молекулы от поверхности. Закон отражения молекулы от поверхности задают значением исходного признака *LOT*.

2.12.1. При зеркальном отражении (*LOT* = -1) компоненты скорости  $\xi_{-i}$  отраженной молекулы газа равны

$$\xi_{-i} = \xi_{+i} - 2(\xi_{+i} \cdot n_i)n_i, \quad i=1, 2, 3, \quad (4)$$

где  $n_i$  — компоненты единичного вектора внутренней нормали к поверхности;

$\leftarrow + \right\rangle$  и  $\leftarrow - \right\rangle$  — индексы, обозначающие соответственно сталкивающиеся и отраженные от поверхности молекулы.

2.12.2. При зеркально-диффузном отражении молекулы газа от поверхности (*LOT* = 1) задают исходные данные:

коэффициент *FIN* — часть диффузно отражающихся молекул;

функцию  $\varphi_e$ ;

зависимость коэффициента аккомодации энергии  $\sigma_e$  от угла столкновения молекулы газа  $\theta_{+e}$  с поверхностью при характерном значении энергии столкновения молекул  $E_{+e}$ , вычисляемом по формуле

$$E_{+e} = 0,8629 \cdot 10^{-4} S_{\infty}^2 T_{\infty}, \quad (5)$$

где  $S_{\infty}$  — отношение скорости набегающего потока газа к наиболее вероятной скорости молекул набегающего потока;

$T_{\infty}$  — температура набегающего потока газа.

Параметры  $\varphi_e$  и  $\sigma_e$  имеют в программе идентификаторы соответственно *FIE* и *SIGE*.

Функцию  $\varphi_e$ , описывающую изменение  $\sigma_e$  в зависимости от энергии молекулы  $E_{+e}$  при характерном значении угла столкновения молекулы  $\theta_{+e}$  ( $0^\circ < \theta_{+e} < 90^\circ$ ), вычисляют по формуле

$$\varphi_e(E_{+e}, \theta_{+e}) = \frac{\sigma_{ew} - \sigma_e(\theta_{+e}, E_{+e})}{\sigma_{ew} - \sigma_e(\theta_{+e}, E_{+e})}, \quad (6)$$

где  $\sigma_{ew} = 1$  — значение коэффициента  $\sigma_e$  для случая равновесного отражения молекул от поверхности.

Зависимость  $\varphi_k(E_+, \Theta_{+k})$  принимают неизменной при любых значениях  $\Theta_{+k}$ .  
Коэффициент  $\sigma_k$  вычисляют по формуле

$$\sigma_k = \frac{E_+ - E_-}{E_+ + E_-} \quad (7)$$

где  $E$  — энергия молекул;

$w$  — индекс, обозначающий молекулу, отраженные равномерно с поверхности единичной площади в единицу времени.

При  $FIN=1$ ,  $\sigma_e = \sigma_n = 1$  отражение молекул от поверхности полностью диффузное при температуре поверхности  $T_w$ .

2.12.3. Параметры функции распределения Максвелла отраженных молекул газа (при  $LOT=2$ ) вычисляют заданием коэффициентов аккомодации  $\sigma_e$ ,  $\sigma_n$  и  $\sigma_\tau$ , имеющих в программе идентификаторы соответственно  $SIGE$ ,  $SIGN$ ,  $SIGT$ .

Коэффициент  $\sigma_e$  вычисляют по формуле (7).

Коэффициенты  $\sigma_n$  и  $\sigma_\tau$  вычисляют по формулам:

$$\sigma_n = \frac{P_{+n} - P_{-n}}{P_{+n} + P_{-n}} \quad (8)$$

$$\sigma_\tau = \frac{P_{+\tau} - P_{-\tau}}{P_{+\tau} + P_{-\tau}} \quad (9)$$

где  $P$  — компоненты импульса молекул, сталкивающихся и отраженных в единицу времени от единицы площади поверхности в направлении единичного вектора внутренней нормали  $\vec{n}$  (индекс  $n$ ) и касательной  $\vec{\tau} = [n \times (\vec{\xi}_+ \times n)] / (|\vec{\xi}_+| \sin \Theta^+)$  к поверхности (индекс  $\tau$ ).

Процесс перехода молекулы от неравновесного состояния при больших энергиях к равновесному состоянию при повторных столкновениях молекулы с возгнотой поверхности ИСЗ задают функциями  $\varphi_k(E_+, \Theta_{+k})$ ,  $k=e, n, \tau$ , имеющих в программе идентификаторы соответственно  $FIE$ ,  $FIN$ ,  $FIT$ .

Функции  $\varphi_k$  вычисляют по формуле

$$\varphi_k(E_+, \Theta_{+k}) = \frac{\sigma_{kw} - \sigma_k(\Theta_{+k}, E_+)}{\sigma_{kw} + \sigma_k(\Theta_{+k}, E_+)} \quad (10)$$

где  $\sigma_{kw}=1$  — значения коэффициентов аккомодации  $\sigma_e$ ,  $\sigma_n$ ,  $\sigma_\tau$  для случая равновесного отражения молекул газа от поверхности.

Зависимости  $\varphi_k(E_+, \Theta_{+k})$  принимают справедливыми для любых значений  $\Theta_{+k}$ .

Коэффициенты аккомодации при произвольных значениях  $\Theta_{+k}$  и  $E_+$  вычисляют по формуле

$$\sigma_k(\Theta_{+k}, E_+) = 1 - \varphi_k(E_+, \Theta_{+k}) [1 - \sigma_k(\Theta_{+k}, E_+)], \quad k=e, n, \tau. \quad (11)$$

При  $\varphi_k = \sigma_k = 1$  отражение молекул от поверхности полностью диффузное с температурой поверхности  $T_w$ .

2.12.4. При отражении молекул от поверхности в соответствии с лучевой моделью ( $LOT=3$ ) задают две зависимости

$$\Theta_- = f_1(\Theta_+), \quad (12)$$

$$|\vec{\xi}_-| |\vec{\xi}_+| = f_2(\Theta_+), \quad (13)$$

где  $\Theta$  — угол отражения молекулы от поверхности;

$\xi$  — скорость отраженной молекулы.

В программе зависимости (12) и (13) имеют идентификаторы соответственно  $FIE$  и  $SIGE$ .

2.12.5. При значении идентификатора  $LOT=-4$  производят расчет в соответствии с теорией Ньютона для гиперзвукового потока вязкого газа.

2.12.6. При значении идентификатора  $LOT=4$  производят расчет в потоке света (фотонов). В этом случае коэффициент  $FIN$  равен части поглощенного (диффузно отраженного) светового потока. Часть потока, проходящего через поверхность, моделируют заданием коэффициента пористости для соответствующей поверхности.

2.12.6.1. Аэродинамические коэффициенты в световом потоке отнесены к скоростному напору потока фотонов, который вычисляют по формуле

$$q_\phi = E_\phi / 2C_\phi, \quad (14)$$

где  $E_\phi$  — поток световой энергии на единицу площади в единицу времени;

$C_\phi$  — скорость света.

2.13. Последовательные соударения и отражения молекул от поверхности ИСЗ с заданным законом отражения (случайные траектории молекул, имеющие начало на контрольной поверхности) разыгрывают до тех пор, пока молекула не выйдет за пределы КП или не произойдет количество допустимых столкновений.

2.14. После выбора  $N_p$  случайных траекторий молекул для  $\nu$ -й поверхности второго порядка ИСЗ в связанных осях координат  $Xx_\nu$  рассчитывают математические ожидания коэффициентов:

аэродинамических сил  $C_{x,\nu}^E$ ,  $C_{r,\nu}^E$ ;

аэродинамических моментов  $m_{x,\nu}^E$ ,  $m_{z,\nu}^E$ ;

потоков энергии  $C_{x,\nu}^E$ ,  $C_{r,\nu}^E$ .

Коэффициенты от первого столкновения и отражения молекул от поверхности вычисляют по формулам:

$$C_{x,\nu}^E = \pm \frac{1}{N_p} \sum_{\tau=1}^{T=N_p} \rho A_\tau \xi_{\pm 1,\nu}, \quad (15)$$

$$m_{\pm vt} = \pm \frac{1}{D_{\infty} N_p} \sum_{\tau=1}^{\tau=N_p} A_{\tau} (x_{\pm 1t} \times \xi_{\pm 1vt}), \quad (16)$$

$$C_{\pm v}^E = \pm \frac{1}{2V_{\infty} N_p} \sum_{\tau=1}^{\tau=N_p} A_{\tau} |\xi_{\pm 1vt}|^2, \quad (17)$$

где  $A_{\tau} = \frac{\mu_{\tau} \bar{n}_{\tau} N_p}{\sqrt{\pi} S_M V_{\infty} \mu_{\text{ср}} S_{\infty \tau} N_{p1} k_{\tau-1}} \sum_{k=1}^{k=6} F_k (e^{-S_{\infty \tau k}^2} + \sqrt{\pi} S_{\infty \tau k} [1 + \text{erf}(S_{\infty \tau k})])$  — нормирующий множитель,

- $N_{p1}$  — количество молекул, разыгранных с КП для каждой компоненты  $\gamma$  газа;  
 $V_{\infty}$  — скорость набегающего потока газа;  
 $D_M$  — характерный размер ИСЗ;  
 $S_M$  — характерная площадь ИСЗ;  
 $\mu_{\text{ср}}, \mu_{\tau}$  — средний молекулярный вес и компоненты  $\gamma$  газа;  
 $\bar{n}_{\tau}$  — относительная концентрация частиц компоненты  $\gamma$  газа;  
 $S_{\infty \tau}$  — отношение скорости набегающего потока газа к наиболее вероятной скорости молекул компоненты  $\gamma$  набегающего потока газа;  
 $S_{\infty \tau k}$  — проекция вектора  $S_{\infty \tau}$  на орты внутренних нормалей к граням КП;  
 $F_k$  — площадь  $k$ -й грани КП.  
 Коэффициенты (индекс  $r$ ) от последующих повторных толкновений и отражений молекул (второго, третьего и т. д.) до выхода молекулы из объема, ограниченного КП, вычисляют по формулам:

$$C_{r+1} = \frac{1}{N_p} \sum_{\tau=1}^{\tau=N_p} A_{\tau} (\xi_{+2vt} - \xi_{-2vt} + \dots - \xi_{-rvt}), \quad (18)$$

$$m_{r+1} = \frac{1}{D_M N_p} \sum_{\tau=1}^{\tau=N_p} A_{\tau} [(x_{\pm 1t} \times \xi_{+2vt}) - (x_{\pm 1t} \times \xi_{-2vt}) + \dots - (x_{\pm 1t} \times \xi_{-rvt})], \quad (19)$$

$$C_{r+1}^E = \frac{1}{2V_{\infty} N_p} \sum_{\tau=1}^{\tau=N_p} A_{\tau} (|\xi_{+2vt}|^2 - |\xi_{-2vt}|^2 + \dots - |\xi_{-rvt}|^2). \quad (20)$$

Суммарные коэффициенты  $v$ -й поверхности второго порядка вычисляют по формулам:

$$C_{vt} = C_{+vt} + C_{-vt} + C_{rvt}, \quad (21)$$

$$m_{vt} = m_{+vt} + m_{-vt} + m_{rvt}, \quad (22)$$

$$C_{vt}^E = C_{+vt}^E + C_{-vt}^E + C_{rvt}^E. \quad (23)$$

Суммарные коэффициенты  $C_t, m_t, C^E$  для всей поверхности ИСЗ и для произвольных групп поверхностей второго порядка вычисляют суммированием коэффициентов, вычисленных по формулам (15—23) для поверхностей второго порядка ИСЗ.

Коэффициенты аэродинамических моментов в формулах (16, 19, 22) вычисляют относительно начала координат — точки  $X$ . В программе производят расчет коэффициентов аэродинамических моментов относительно заданных точек (центров тяжести ИСЗ) и суммарных аэродинамических коэффициентов в скоростной системе координат с началом координат в точке  $X$ .

В формулах (15—23) коэффициенты аэродинамических сил  $C_{\pm vt}, C_{rvt}$  отнесены к  $m_{\infty} V_{\infty}^2 S_M / 2$ , коэффициенты аэродинамических моментов — к  $m_{\infty} V_{\infty}^2 S_M D_M / 2$ , коэффициенты потоков энергии — к  $m_{\infty} V_{\infty}^3 S_M / 2$ , где  $m, n_{\infty}$  — соответственно масса и концентрация молекул набегающего газа.

2.15. Средние квадратические отклонения суммарных коэффициентов  $C_t, m_t, C^E$  вычисляют по формулам:

$$\sigma_{C_t} = \left( \frac{S_{C_t} (N_p - C_t^2)}{N_p} \right)^{1/2}, \quad (24)$$

$$\sigma_{m_t} = \left( \frac{S_{m_t} (N_p D_M^2 - m_t^2)}{N_p} \right)^{1/2}, \quad (25)$$

$$\sigma_{C^E} = \left( \frac{S^E (4N_p) - (C^E)^2}{N_p} \right)^{1/2}, \quad (26)$$

$$\text{где } S_{C_t} = \sum_{\tau=1}^{\tau=N_p} A_{\tau}^2 (\xi_{+1t} - \xi_{-pt})^2, \quad (27)$$

$$S_{m_t} = \sum_{\tau=1}^{\tau=N_p} A_{\tau}^2 [(x_{\pm 1t} \times \xi_{+1t}) - (x_{\pm 1t} \times \xi_{-pt})]^2, \quad (28)$$

$$S^E = \frac{1}{V_{\infty}^2} \sum_{\tau=1}^{\tau=N_p} A_{\tau}^2 (|\xi_{+1t}|^2 - |\xi_{-pt}|^2)^2, \quad (29)$$

2.16. В переходной области обтекания аэродинамические коэффициенты рассчитывают в соответствии с гипотезой локальности по формуле

$$C_k = W_1 C_{-kn} + W_2 C_{+kn} + W_3 C_{+kt}, \quad k = x, y, z, \quad (30)$$

где  $C_k$  — обозначает суммарные аэродинамические коэффициенты  $C_x, C_y, C_z, m_x, m_y, m_z$  в связанных осях ИСЗ  $Xx_i$ ;  $W_1, W_2, W_3$  — коэффициенты, зависящие от значения параметра режима обтекания;  $C_{-kn}, C_{+kn}, C_{+kt}$  — коэффициенты формы, зависящие от формы тела и вычисляемые по программе, определяют при равновесном отражении молекул от поверхности с учетом импульсов первого столкновения (индекс +) и первого отражения (индекс —) молекул от поверхности;

$n$  и  $t$  — индексы, обозначающие коэффициенты, полученные от учета компонент импульсов молекул, параллельных внутренней нормали к поверхности (индекс  $n$ ) и параллельных касательной к поверхности (индекс  $t$ ).

В программе коэффициенты режима  $W_1, W_2, W_3$  задают в зависимости от параметра режима, имеющей идентификатор  $HKM$ .

2.17. При вычислении частных производных аэродинамических коэффициентов по компонентам безразмерной угловой скорости ИСЗ скорость столкновения молекул с поверхностью рассчитывают по формуле

$$\xi_{i\lambda l} = \xi_{-(\lambda-1)l} - \omega_l \times (x_{\lambda l} - x_{*l}), \quad (31)$$

где  $\xi_{+\lambda l}$  — скорость столкновения молекулы с поверхностью в точке  $x_{\lambda l}$ ;

$\xi_{-(\lambda-1)l}$  — скорость молекулы, начавшей движение от точки  $x_{(\lambda-1)l}$ ;

$\omega_l$  — угловая скорость ИСЗ;

$x_{*l}$  — координаты точки — центра вращения ИСЗ.

В программе величины  $\omega_l$  и  $x_{*l}$  имеют идентификаторы  $OM$  и  $XB$  соответственно.

### 3. ОПИСАНИЕ ПРОГРАММЫ

3.1. Ввод исходных данных и вывод их на печать (в точной последовательности ввода) производит подпрограмма, имеющая идентификатор  $INPUT$  и расположенная за главной программой, имеющей идентификатор  $MA3$ .

3.2. Входную информацию подготавливают на перфокартах согласно операторам ввода  $READ$  в последовательности, указанной в подпрограмме  $INPUT$ .

3.3. Все идентификаторы вводимых параметров снабжены подробными комментариями, расположенными перед соответствующими операторами  $READ$ .

3.4. Для удобства пользования все операторы  $READ$  снабжены чертой слева при безусловном вводе и двумя чертами слева — при условном вводе. Условия ввода приведены в комментариях.

3.5. Результаты расчета программа выдает на печать в следующей последовательности:

угол атаки ИСЗ в градусах;

угол скольжения ИСЗ в градусах;

высота полета ИСЗ в километрах;

признак закона отражения молекул ( $LOT$ );

признак печати ( $LPR$ );

скорость набегающего потока газа;

температура набегающего потока газа  $T_\infty$ ;

температура поверхности ИСЗ  $T_w$ ;

средний молекулярный вес газа;

скоростное отношение  $S_\infty$ ;

отношение скорости набегающего потока газа к наиболее вероятной скорости молекул газа при температуре поверхности

$$S_w = S_\infty \sqrt{\frac{T_\infty}{T_w}};$$

количество случайных траекторий молекул, имеющих начало на КП;

вероятность пересечения случайной траектории молекулы с поверхностью ИСЗ;

среднее число столкновений молекулы с поверхностью ИСЗ;

количество типовых поверхностей;

количество поверхностей второго порядка;

номер поверхности второго порядка и значения аэродинамических коэффициентов и коэффициента потока энергии в связанных осях  $Xx_i$  для каждой поверхности второго порядка и для каждой произвольной группы поверхностей второго порядка с выделением слагаемых, получающихся при учете только первого столкновения, первого отражения и всех повторных столкновений и отражений молекул от вогнутой поверхности ИСЗ;

суммарные аэродинамические коэффициенты ИСЗ  $C_x, C_y, C_z, m_x, m_y, m_z$  и суммарный коэффициент потока энергии в связанных осях  $Xx_i$  и их средние квадратические отклонения  $\sigma_{C_x}, \sigma_{C_y}, \sigma_{C_z}, \sigma_{m_x}, \sigma_{m_y}, \sigma_{m_z}, \sigma_{CE}$  с выделением слагаемых от первого столкновения, первого отражения и повторных столкновений и отражений молекул от вогнутой поверхности ИСЗ;

координаты центра тяжести ИСЗ и коэффициенты аэродинамических моментов  $m_x, m_y, m_z$  в связанных осях;

суммарные аэродинамические коэффициенты  $C_{x\alpha}, C_{y\alpha}, C_{z\alpha}, m_{x\alpha}, m_{y\alpha}, m_{z\alpha}$  в скоростной системе координат с началом координат в точке  $X$ ;

суммарные аэродинамические коэффициенты ИСЗ в связанных осях в переходной области;

частные производные аэродинамических коэффициентов в связанных осях по безразмерной угловой скорости ИСЗ.

4. ПРОГРАММА РАСЧЕТА АЭРОДИНАМИЧЕСКИХ КОЭФФИЦИЕНТОВ ИСЗ  
НА АЛГОРИТМИЧЕСКОМ ЯЗЫКЕ ФОРТРАН

```

1  PROGRAM MA3
2  DIMENSION RM(24),DN(9),AJ(9),DP(9),DPK(6),
      CP(6),VB0(6),XS(3),V0X(3)
3  *1,DS(3),D(3),SG(6),VBG(6)
4  COMMON/BL2/HW,MU,FM12,SB,HB,OPTN(3),RC,RS,
      RES27,KPT(30),NT,N,N1,N2,
5  *D1,P2(2),TEL(108)/BL2/AI(3),3.50,AA(3),50,AA
      4(50)
6  */BLT/T1(3),T2(3),T3(3),TA(3),T5(3),T6(3),
      2(3)
7  *,T8(3),T9(3)/BLC/C0(3),C1(3),C2(3),C3(3),C
      4(3)
8  */RES1/AL(18),BE(18),H(9),LOT,LOD,VB,TB,SW,
      TW,NRT,NR,NS,KSS,AD,
9  *DM,NCT,IA,IB,IM,E1(50),E2(50),E3(50),S1(3,
      50),S2(3,50),S3(3,50),
10 *CM1(3,50),CM2(3,50),CM3(3,50),S5(3),CM5(3)
      ,E5,CT(3,3),AH(24),
11 *MUH(9),MH(24,9),TBH(24),VBH(24),NH,NB,NA,K
      D,LPR,NR1,NR2,SM,CP
12 */BLB/PPR(50),MD(50),MD1(50),MD2(50),KPR,KP
      D,KKG
13 */R1P1/LPO/LBR,OM(3),XB(3)
14 */R1P2/SIN(3),S1T(3),CM1N(3),CM1T(3),S2N(3)
      ,CM2N(3),S1NB(3),S1TB(3)
15 *,CM1NB(3),CM1TB(3),S2NB(3),S2TB(3),CM2NB(3)
      ,CM2TB(3),S2T(3),CM2T(3)
16 *1
17  EXTERNAL F2
18  DATA PI/3.14159265,GR/.017453292/
19  PFAI MUH,MU
20  INTEGER P1P2
21 1000 CALL INPUT
22  8 DO 9 I=1,3
23  9 C0(I)=0
24  FM12=1/SQRT(PI)
25  DO100 IM=1,NH
26  TB=AINTR(M(IM),AH,TBH,9,FALSE)
27  VB=AINTR(M(IM),AH,VBH,9,FALSE)
28  IF (ABS(LOT),NE,4) GO TO 7
29  KKG=1
30  TB=1
31  IF (LOT,NE,-4) GO TO 7
32  SM=SM*4/1.84
33  LOT=-1
34  KD=1
35  7 DO 100 IB=1,NB
36  DO100 IA=1,NA
37  PRINT 10,M(IM),AL(IA),BF(IB)
38 10 FORMAT('///ВЫСОТА',E10,4,5X,'УГОЛ АТАКИ',E
      10,4,5X,'УГОЛ СКОЛЬЖЕНИЯ
39  *,F10,4//)
40  NS=0

```



```

41      KSS=0
42      WRT=0
43      FS=0
44      DO 45 I=1,N
45          E1(I)=0
46          E2(I)=0
47          E3(I)=0
48          DO 45 J=1,3
49              S1(I,J)=0
50              S2(I,J)=0
51              S3(I,J)=0
52              CM1(I,J)=0
53              CM2(I,J)=0
54          45 CM3(I,J)=0
55          VB0(I)=-COS(AL(I)*GR)+COS(BE(I)*GR)
56          VB0(I)=SIN(AL(I)*GR)+COS(BE(I)*GR)
57          VB0(I)=-SIN(BE(I)*GR)
58          SG(I)=(CP(5)-CP(2)-.002)+ICP(6)-CP(3)+.002
59          SG(2)=(CP(4)-CP(1)+.002)+ICP(6)-CP(3)+.002
60          SG(3)=(CP(4)-CP(1)+.002)+ICP(5)-CP(2)+.002

61      DO 17 I=1,3
62          S5(I)=0
63          CM5(I)=0
64          S1N(I)=0
65          S1T(I)=0
66          CM1N(I)=0
67          CM1T(I)=0
68          S2N(I)=0
69          CM2N(I)=0
70          S1NB(I)=0
71          S1TB(I)=0
72          CM1NB(I)=0
73          CM1TB(I)=0
74          S2NB(I)=0
75          S2TB(I)=0
76          CM2NB(I)=0
77          CM2TB(I)=0
78          S2T(I)=0
79          CM2T(I)=0
80          VB0(I+3)=-VB0(I)
81      17 SG(I+3)=SG(I)
82          CMU=0
83          DO 25 I=1,KKG
84      25 DN(I)=0
85          R=ALOG(10)
86          DO 30 I=1,KKG
87              DO 26 J=1,24
88      26 RM(I)=HN(I,I)
89              HNI=AINTR(H(IH),AH,RM,24,FALSE)
90              DO 30 J=1,KKG
91                  DO 28 J1=1,24
92      28 RM(J1)=HN(J1,J)
93              HNJ=AINTR(H(IH),AH,RM,24,FALSE)
94      30 DN(I)=DN(I)+EXP(R*(HNJ-HNI))
95          DO 31 I=1,KKG
96          DN(I)=1/DN(I)

```

```

97      * AI(I)=0
98      31 CMU=CMU+MUH(I)*DN(I)
99      R=0
100     DO 32 I=1,6
101     32 DP(I)=0
102     DO 33 J=1,KKG
103     DO 33 K=1,6
104     SB=VB/SQRT(16629.28887*TB/MUH(I))
105     R=R+SG(K)*HI(SB*VB0(K))*DN(I)/SB
106     DP(I)=DP(I)+SG(K)*HI(SB*VB0(K))*DN(I)/SB
107     33 AI(I)=AI(I)+SG(K)*HI(SB*VB0(K))*DN(I)/SB*M
           MUH(I)/CMU
108     DO 34 J=1,KKG
109     34 DP(I)=DP(I)/R
110     A0=1/SQRT(PI)/yB/SM
111     DO 76 IK=1,KKG
112     KN=INT(DP(IK)*NR+.5)
113     IF(N, EQ, 0) GO TO 76
114     DO 35 J=1,6
115     SB=VB/SQRT(16629.28887*TB/MUH(IK))
116     35 DPK(I)=DN(IK)*SG(I)*HI(SB*VB0(I))/SB/DP(IK)
           )/R
117     DO 76 K=1,6
118     NK=INT(DPK(K)*KN+.5)
119     IF(NK, EQ, 0) GO TO 76
120     MU=MUH(IK)
121     HR=SQRT(16629.28887*TB/MUH(IK))
122     HW=HR*SQRT(TL/TR)
123     SB=VB/HR
124     SW=VB/HW
125     DO 37 I=1,6
126     37 VBG(I)=VB0(I)*SB
127     BB=AI(IK)*A0*NR/KN
128     AA=BB
129     NG=K-(K-1)/3*3
130     IF(VBG(K)) 14,15,15
131     14 R1=0
132     R2=-9/((2*VBG(K))-2.7692*EXP(VBG(K)))
133     GO TO 18
134     15 IF(VBG(K)-3.25) 16,17,17
135     16 R1=0
136     R2=VBG(K)+3.25
137     GO TO 18
138     17 R1=VBG(K)-3.25
139     R2=6.5
140     18 FMO=F2(VBG(K)/2+SQRT(VBG(K)**2/4+.5),VBG(K)
           )
141     DO 76 IC=1,NK
142     NRT=NRT+1
143     XS(NG)=CP(K)+SIGN(0.001,K-3.1)
144     DO 19 I=1,3
145     IF(I, EQ, NG) GO TO 19
146     XS(I)=CP(I)-.001+(CP(I+3)-CP(I)+.002)*RNDM
           (-1)
147     19 CONTINUE
148     VOX(NG)=SIGN(BIRD(F2,R1,R2,FMO,VBG(K)),3,1
           -K)
149     B1=SQRT(-ALOG(RNDM(-1)))

```

```

150      B3=2*PI*RNDR(-1)
151      B2=COS(B3)
152      B3=SIN(B3)
153      DO 20 I1=1,3
154      IF(I1, EQ, NG) GO TO 20
155      V0X(I1)=V0G/I1+B1*B2
156      B2=B3
157      20 CONTINUE
158      VM=RAST(CO, V0X)*HB
159      23 CALL NCOS(CO, V0X, V0X)
160      DO 52 I10=1,3
161      DS(I10)=0
162      52 D(I10)=0
163      DE=0
164      KS=0
165      57 IF(KS, GE, KD) GO TO 70
166      TM=1, E14
167      DO 58 I3=1, N
168      IF(KPR, EQ, 0, AND, KPD, EQ, 0) GO TO 56
169      IF((MD(I3), NE, 0), OR, (FPR(I3), GE, .9999, AND,
170      MD1(I3), EQ, 0)) GO TO 58
171      56 CALL SY(I3, XS, V0X, T)
172      IF(T, GE, TM) GO TO 58
173      TM=T
174      NP=I3
175      58 CONTINUE
176      59 IF(TM, GT, .9E14) GO TO 70
177      KS=KS+1
178      DO 60 I4=1,3
179      XS(I4)=XS(I4)+V0X(I4)*TM
180      IF(KS, NE, 1) GO TO 65
181      NS=NS+1
182      CALL VECTOR(XS, V0X, T1)
183      DO 61 I5=1,3
184      S1(I5, NP)=S1(I5, NP)+V0X(I5)*VM*BB
185      CM1(I5, NP)=CM1(I5, NP)+T1(I5)*VM*BB
186      DS(I5)=V0X(I5)*VM*AA
187      61 D(I5)=T1(I5)*VM*AA
188      VM2=VM*VM
189      E1(NP)=E1(NP)+VM2*BB
190      DE=VM2*AA
191      IF(LPO, EQ, 0) GO TO 80
192      CALL ORT(XS, ORTN, NP)
193      CALL SJST(V0X)
194      VMN=VM*ABS(RC)
195      VMT=VM*SCALAR(V0X, C1)
196      CALL VECTOR(XS, C3, T2)
197      CALL VECTOR(XS, C1, T3)
198      DO 81 I=1,3
199      S1N(I)=S1N(I)-C3(I)*VMN*BB
200      S1T(I)=S1T(I)+C1(I)*VMT*BB
201      CM1N(I)=CM1N(I)-T2(I)*VMN*BB
202      81 CM1T(I)=CM1T(I)+T3(I)*VMT*BB
203      80 IF(LBR, EQ, 0) GO TO 85
204      DO 82 I=1,3
205      T9(I)=XS(I)-XB(I)
206      82 CALL VECTOR(OM, T9, T4)
207      DO 83 I=1,3

```

```

207      85 T9(I)=VM*V0X(I)-T4(I)
208      B1=RAS(TC0,T9)
209      CALL NCOS(C0,T9,T8)
210      CALL OTR(XS,OPTN,NP)
211      B2=ABS(B1*SCALAR(T8,ORTN)/VM/SCALAR(V0X,ORTN))
212      CALL SJST(T8)
213      VMN=B1*ABS(RC)
214      VMT=B1*SCALAR(T8,C1)
215      CALL VECTOR(XS,C3,T5)
216      CALL VECTOR(XS,C1,T6)
217      DO 84 I=1,3
218          S1NB(I)=S1NB(I)-C3(I)+VMN*BB*B2
219          S1TB(I)=S1TB(I)+C1(I)+VMT*BB*B2
220          CM1NB(I)=CM1NB(I)-T5(I)+VMN*BB*B2
221      84 CM1TB(I)=CM1TB(I)+T6(I)+VMT*BB*B2
222      RR=RNDM(-1)
223      CALL RNDM1(RR)
224      85 CALL OTR(XS,VM,V0X,NP,LOT)
225      CALL VECTOR(XS,V0X,T1)
226      DO 62 J=1,3
227          S2(I6,NP)=S2(I6,NP)-V0X(I6)*VM*BB
228          CM2(I6,NP)=CM2(I6,NP)-T1(I6)*VM*BB
229          DS(I6)=DS(I6)-V0X(I6)*VM*AA
230      62 D(I6)=D(I6)-T1(I6)*VM*AA
231      VM2=VM*VM
232      DE=DE-VM2*AA
233      E2(NP)=E2(NP)-VM2*BB
234      IF(LPO.EQ.0) GO TO 87
235      VMN=VM*ABS(SCALAR(V0X,ORTN))
236      VMT=VM*SCALAR(V0X,C1)
237      DO 86 I=1,3
238          S2N(I)=S2N(I)-C3(I)+VMN*BB
239          S2T(I)=S2T(I)-C1(I)+VMT*BB
240          CM2N(I)=CM2N(I)-T2(I)+VMN*BB
241      86 CM2T(I)=CM2T(I)-T3(I)+VMT*BB
242      87 IF(LDR.EQ.0) GO TO 89
243      CALL RNDM1(RR)
244      CALL OTR(XS,B1,T8,NP,LOT)
245      VMN=B1*ABS(SCALAR(T8,C3))
246      VMT=B1*SCALAR(T8,C1)
247      CALL VECTOR(XS,C1,T6)
248      DO 88 I=1,3
249          S2NB(I)=S2NB(I)-C3(I)+VMN*BB*B2
250          S2TB(I)=S2TB(I)-C1(I)+VMT*BB*B2
251          CM2NB(I)=CM2NB(I)-T5(I)+VMN*BB*B2
252      88 CM2TB(I)=CM2TB(I)-T6(I)+VMT*BB*B2
253      89 GO TO 57
254      65 CALL VECTOR(XS,V0X,T1)
255      DO 66 I7=1,3
256          S3(I7,NP)=S3(I7,NP)+V0X(I7)*VM*BB
257          CM3(I7,NP)=CM3(I7,NP)+T1(I7)*VM*BB
258          DS(I7)=DS(I7)+V0X(I7)*VM*AA
259      66 D(I7)=D(I7)+T1(I7)*VM*AA
260      VM2=VM*VM
261      E3(NP)=E3(NP)+VM2*BB
262      DE=DE+VM2*AA
263      CALL OTR(XS,VM,V0X,NP,LOT)
264      CALL VECTOR(XS,V0X,T1)

```

```

265      DO 67 I8=1,3
266      S3(I8,NP)=S3(I8,NP)-V0X(I8)*VM*BB
267      CM3(I8,NP)=CM3(I8,NP)-T1(I8)*VM*BB
268      DS(I8)=DS(I8)-V0X(I8)*VM*AA
269      67 D(I8)=D(I8)-T1(I8)*VM*AA
270      VM2=VM*VM
271      E3(NP)=F3(NP)-VM2*BB
272      DE=DE-VM2*AA
273      GO TO 57
274      70 DO 71 I9=1,3
275      S5(I9)=S5(I9)+DS(I9)**2
276      71 CM5(I9)=CM5(I9)+D(I9)**2
277      E5=E5+(DE/VB)**2
278      KSS=KSS+KS
279      74 CONTINUE
280      MU=CMU
281      HB=SQRT(10629.28887*TB/MU)
282      HW=HB*SQRT(TW/TB)
283      SB=VB/HB
284      SW=VB/HW
285      102 CALL RESULT(LPR)
286      100 CONTINUE
287      GO TO 1000
288      END
289      BLOCK DATA
290      COMMON/RES1/AL(18),RE(18),M(9),LOT,L0D,VB,
291      *A0,DM,NCT,IA,IB,IM,E1(50),E2(50),E3(50),S1
292      *50),CM1(3,50),CM2(3,50),CM3(3,50),S5(3),CM
293      *5(3),E5,GT(3,3),AH(24),
294      *MUH(9),MH(24,9),TBH(24),VBH(24),NH,NB,NA,K
295      *D,LPR,NR1,NR2,SM,CP
296      REAL MUH
297      DATA (AH=90.,100.,110.,130.,150.,
298      *170.,200.,250.,300.,350.,400.,440.,500.,60
299      *0.,700.,900.,1100.,
300      *1300.,1500.,1700.,1900.,2100.,2300.,2500.)
301      ,(MUH=28.0134,31.9988,
302      *15.9994,39.948,4.0026,1.00797),((MH(I,1),I
303      =1,16)=13.7498,12.9516,
304      *12.2049,11.0978,10.4352,9.9687,9.6126,8.63
305      *41,7.9318,7.2634,6.6144,
306      *6.1052,5.3551,4.1366,2.9942,,6885),((MH(I,
307      1),I=17,24)=8(0.)),
308      *((MH(I,2),I=1,15)=13.1687,12.2678,11.4289,
309      *10.2016,9.4666,8.9445,
310      *8.3172,7.4336,6.6334,5.8709,5.1299,4.5484,
311      *3.6917,2.2999,,9493),
312      *((MH(I,2),I=16,24)=9(0.)),((MH(I,3),I=1,20
313      *)=11.8225,12.0390,
314      *11.5704,10.8256,10.3811,10.0822,9.7407,9.2
315      *794,8.8719,
316      *8.4876,8.1158,7.8243,7.3956,6.6994,6.0240,
317      *4.7299,3.5056,2.3454,
318      *1.2444, 1980),((MH(I,3),I=21,24)=4(0.)),((
319      *MH(I,4),I=1,13)=
320      *11.8276,11.0294,10.0064,8.5394,7.6601,7.02

```



```

72,0,2578,5,1044,4,1091,
308 *3 2186,2,2943,1 5686,,4993),((HN(1,4),I=14
,24)=11(0,)),((HN(1,5),
309 *1=1,24)=8,6457,7,8475,7,6940,7,4107,7,2424
,7,1396,7,0337,6,9038,
310 *6 7964,6,698,,0 6040,6,3307,6,4231,6,2487,
6,0796,5,7558,5,4494,
311 *5 1595,4,8838,4 6220,4,3779,4,1356,3,9093,
3,6932),((HN(1,6),I=1,
312 *12)=12(0,)),((HN(1,6),I=13,24)=4,4375,4,30
31,4,3503,4,2680,4,1914,
313 *4 1183,4 0489,3,9830,3,9203,3,8603,3,8035,
3,7491),((TBM=183,,194,2,
314 *243,5,445,4,635 2,756,2,859,3,940,2,972,8,
986,5,992,6,1995,2,997,3,
315 *998 8,999,4,999 8,999,9,999,9,1000,,1000,,
1000,,1000,,1000,,1000,)
316 *((VBN=7855,,7850 ,7845,,7832,,7820,,7808,,7
788,,7761,,7734,,7705,,
317 *7(72,,7655 ,7620,,7561,,7510,,7405,,7305,,
7208,,7114,,7027,,6940.))
318 *6858,,6778,,6700)
319 END
320 SUBROUTINE INPUT
321 COMMON/PES1/AL(18),BE(18),
322 *M(9),LAT,LOD,VB,TB,SW,TW,NRT,NR,NS,KSS,AD,
323 *DM,NCT,IA,IB,IC,IE1(50),E2(50),E3(50),S1(3,
50),
324 *S2(3,50),S3(3,50),CM1(3,50),CM2(3,50),CM3(
3,50),
325 *S5(3),CM5(3),E5,CT(3,3),AH(24),MUM(9),HN(2
4,9),TBN(24),VBN(24),
326 *NH,NB,NA,KD,LPR,NR1,NR2,SM,CP(6)
327 */RES2/KPT(30),IT,IF,IF1,IF2,IF3(2),F4(108)
328 */BLVD/LKP,FD,FIE(10,5),FIN(10,5),FIT(10,5)
,SIGE(10,
329 *5),SIGN(10,5),SIGT(10,5),MN(50)
330 */BL8/FBR(50),MD(50),MD1(50),MD2(50),KPR,KP
D,KKG
331 */BLP3/HKN(12),W1(12),W2(12),W3(12)
332 */BLP1/PO-LBR,OM(3),XB(3)
333 DIMENSION NPR(50),NPD(50)
334 EQUIVALENCE(N,IF)
335 REAL MUM,MUM1
336 С НАЧАЛЬНЫЕ ДАННЫЕ
337 С NA,NB,NH,NCT-КОЛИЧЕСТВО ЗНАЧЕНИЙ УГЛОВ ДАТКИ,
338 С УГЛОВ СКОЛЬЖЕНИЯ,ВНСОТ ПОЛЁТА ИСЗ И ТОЧЕК-
339 С ЦЕНТРОВ ТЯЖЕСТИ ИСЗ,
340 С LOT-ПРИЗНАК ЗАКОНА ОТРАЖЕНИЯ МОЛЕКУЛ ОТ
341 С ПОВЕРХНОСТИ ИСЗ,
342 С ПРИ LOT=-1 ЗЕРКАЛЬНОЕ ОТРАЖЕНИЕ
343 С ПРИ LOT=1 ЗЕРКАЛЬНО-ДИФФУЗНОЕ ОТРАЖЕНИЕ,
344 С ПРИ LOT=2 ОТРАЖЕНИЕ В СООТВЕТСТВИИ С
345 С ФУНКЦИЕЙ РАСПРЕДЕЛЕНИЯ МАКСВЕЛЛА,
346 С ПРИ LOT=3 ОТРАЖЕНИЕ В СООТВЕТСТВИИ С
347 С ЛУЧЕВОЙ МОДЕЛЬЮ
348 С ПРИ LOT=4 РАСЧЕТ В ПОТОКЕ СВЕТА (ФОТОНОВ)
349 С ПРИ LOT=-4 РАСЧЕТ В СООТВЕТСТВИИ С ТЕОРИЕЙ

```

350 С НЬЮТОНА ДЛЯ ГИПЕРЗВУКОВОГО ПОТОКА  
 351 С НЕВЯЗКОГО ГАЗА  
 352 С LKP-КОЛИЧЕСТВО (НЕ БОЛЬШЕ 5) ЗАВИСИМОСТЕЙ ПА-  
 353 С РАМЕТРОВ ЗАКОНА ОТРАЖЕНИЯ МОЛЕКУЛ ОТ ПО-  
 354 С ВЕРХНОСТЕЙ ВТОРОГО ПОРЯДКА ИСЗ.  
 355 С LPR-ПРИЗНАК ПЕЧАТИ.  
 356 С ПРИ LOR=0 НА ПЕЧАТАТЬ ВЫДАЮТСЯ РЕЗУЛЬТАТЫ  
 357 С РАСЧЕТА СУММАРНЫХ КОЭФФИЦИЕНТОВ. ПРИ LPR=1  
 358 С ВВОДИТСЯ МАССИВ KPT(1-24) И НА ПЕЧАТЬ ВЫ-  
 359 С ДАЮТСЯ КОЭФФИЦИЕНТЫ ДЛЯ ВСЕХ ПОВЕРХНОСТЕЙ  
 360 С ВТОРОГО ПОРЯДКА ИСЗ И ИХ ПРОИЗВОЛЬНЫХ  
 361 С ГРУПП.  
 362 С LN-ПРИЗНАК ВВОДА. ПРИ LN=1 В ПАМЯТЬ ЗВМ ВВО-  
 363 С ДЯТСЯ НОВЫЕ (ВЗАМЕН ИМЕЮЩИХСЯ В ПАМЯТИ ЗВМ)  
 364 С ЗАВИСИМОСТИ ПАРАМЕТРОВ НАБЕГАЮЩЕГО ПОТОКА  
 365 С ГАЗА (МАССИВЫ DN(24), MIN(9), NN(24,9),  
 366 С TBN(24), VBN(24)) ОТ ВЫСОТЫ ПОЛЕТА ИСЗ.  
 367 С ПРИ LN=0 ЗАВИСИМОСТИ НЕ ВВОДЯТСЯ.  
 368 С KPR-КОЛИЧЕСТВО ПОРИСТЫХ ПОВЕРХНОСТЕЙ.  
 369 С KPD-КОЛИЧЕСТВО ОБЛАСТЕЙ ИСКЛЮЧЕНИЯ.  
 370 С KDF-ПРИЗНАК ВВОДА. ПРИ KDF=N ВВОДИТСЯ МАССИВ  
 371 С FIN(1-N) КОЭФФИЦИЕНТОВ ДИФФУЗИОННОГО ОТРАЖЕ-  
 372 С НИЯ ЧАСТИЦ ДЛЯ ВСЕХ ЭЛЕМЕНТАРНЫХ ПОВЕРХ-  
 373 С НОСТЕЙ. ПРИ KDF=1 ВВОДИТСЯ ОДИН КОЭФФИЦИ-  
 374 С ЕНТ FIN, ПОСТОЯННЫЙ ДЛЯ ВСЕХ ПОВЕРХНОСТЕЙ  
 375 С KKB-КОЛИЧЕСТВО КОМПОНЕНТ ГАЗА  
 376 С LPO-ПРИЗНАК РАСЧЕТА В ПЕРЕХОДНОЙ ОБЛАСТИ. ПРИ  
 377 С LPO=1 ВВОДЯТСЯ ЗНАЧЕНИЯ КОЭФФИЦИЕНТОВ РЕ-  
 378 С ЖИМА W1(12), W2(12), W3(12) ДЛЯ СООТВЕТСТВУ-  
 379 С ЮЩИХ ЗНАЧЕНИЙ ПАРАМЕТРА РЕЖИМА ОБТЕКАНИЯ  
 380 С НКН(12) И ПРОИЗВОДИТСЯ РАСЧЕТ КОЭФФИЦИЕН-  
 381 С ТОВ В ПЕРЕХОДНОЙ ОБЛАСТИ.  
 382 С ПРИ LPO=0 РАСЧЕТ НЕ ПРОИЗВОДИТСЯ.  
 383 С LBR-ПРИЗНАК РАСЧЕТА С УЧЕТОМ ВРАЩЕНИЯ. ПРИ  
 384 С LBR=1 ВВОДЯТСЯ КОМПОНЕНТЫ OM(3) ВЕКТОРА  
 385 С УГЛОВОЙ СКОРОСТИ (В РАД/СЕК) И КООРДИНАТЫ  
 386 С XВ(3) ТОЧКИ ВРАЩЕНИЯ ИСЗ И ПРОИЗВОДИТСЯ  
 387 С РАСЧЕТ КОЭФФИЦИЕНТОВ С УЧЕТОМ ВРАЩЕНИЯ.  
 388 С ПРИ LBR=0 ВРАЩЕНИЕ ИСЗ НЕ УЧИТЫВАЕТСЯ.  
 389 С READ 100, NA, NB, NN, NST, LOT, LKP, LPR, LN, KPR,  
 390 С \*KPD, KDF, KKB, LPO, LBR  
 391 С КОЛИЧЕСТВО СЛУЧАЙНЫХ ТРАЕКТОРИЙ МОЛЕКУЛ.  
 392 С KD-КОЛИЧЕСТВО СТОЛКНОВЕНИЙ МОЛЕКУЛЫ С ВОГНУ-  
 393 С ТОЙ ПОВЕРХНОСТЬЮ ИСЗ ПРИ РОЗЫГРЫШЕ ОДНОЙ  
 394 С СЛУЧАЙНОЙ ТРАЕКТОРИИ.  
 395 С READ 120, NR, KD  
 396 С AL(1-NA)-ЗНАЧЕНИЯ УГЛОВ АТАКИ (НЕ БОЛЬШЕ  
 397 С 18 ЧИСЕЛ).  
 398 С READ 110, (AL(I), I=1, NA)  
 399 С VE(1-NB)-ЗНАЧЕНИЯ УГЛОВ СКОЛЬЖЕНИЯ (НЕ БОЛЬШЕ  
 400 С 18 ЧИСЕЛ).  
 401 С READ 110, (VE(I), I=1, NB)  
 402 С H(1-NN)-ЗНАЧЕНИЯ ВЫСОТ ПОЛЕТА ИСЗ (НЕ БОЛЬШЕ  
 403 С 9 ЧИСЕЛ).  
 404 С READ 110, (H(I), I=1, NN)  
 405 С AN(1-24)-ЗНАЧЕНИЯ ВЫСОТ ПОЛЕТА В УЗЛАХ ИНТЕР-  
 406 С ПОЛЯЦИИ.  
 407 С MUN(1-9)-ЗНАЧЕНИЯ МОЛЕКУЛЯРНЫХ ВЕСОВ КОМПО-  
 408 С НЕНТА НАБЕГАЮЩЕГО ГАЗА

```

409 C  HN(I,J)-значения десятичных логарифмов коли-
410 C  ЧЕСТВ АТОМОВ ИЛИ МОЛЕКУЛ В КУБИЧЕСКОМ
411 C  САНТИМЕТРЕ НАБЕГАЮЩЕГО ГАЗА ДЛЯ ВСЕХ
412 C  J(1-9) КОМПОНЕНТ ГАЗА В I(1-24) УЗЛАХ
413 C  ИНТЕРПОЛЯЦИИ
414 C  ТВH(1-24)-значения температуры набегающего
415 C  ГАЗА В УЗЛАХ ИНТЕРПОЛЯЦИИ
416 C  VBH(1-24)-значения скорости набегающего ГАЗА
417 C  В УЗЛАХ ИНТЕРПОЛЯЦИИ
418 C  IF(LN.EQ.0) GO TO 1
419 C  READ 110,(AH(I),I=1,24),(MH(I),I=1,9),
420 C  *((HN(I,J),I=1,24),J=1,9),
421 C  *(TBH(I),I=1,24),(VBH(I),I=1,24)
422 C  1 PRINT 150
423 C  PRINT 160,NA,NB,NH,NCT,LOT,LKP,LPR,LF,KPR,
424 C  *KPD,KDF,KKG,LPO,LBF
425 C  PRINT 170,NR,KD
426 C  PRINT 180,(AL(I),I=1,NA)
427 C  PRINT 190,(BE(I),I=1,NB)
428 C  PRINT 200,(H(I),I=1,NH)
429 C  IF=0
430 C  IF1=1
431 C  ПАРАМЕТРЫ ТИПОВЫХ ПОВЕРХНОСТЕЙ ИСЗ
432 C  PRINT 220
433 C  IT-КОЛИЧЕСТВО ТИПОВЫХ ПОВЕРХНОСТЕЙ ИСЗ
434 C  READ 100,IT
435 C  PRINT 140,IT
436 C  DO 10 IF2=1,IT
437 C  IF3(1-2)-ПРИЗНАКИ P1 И P2 ТИПОВОЙ ПОВЕРХНОСТИ
438 C  READ 100,(IF3(I),I=1,2)
439 C  IF5=18
440 C  IF(IF3(1).EQ.1.OR.IF3(1).EQ.2) IF5=12
441 C  IF(IF3(1).EQ.7) IF5=6*2*IF3(2)
442 C  IF(IF3(1).EQ.8) IF5=24
443 C  F4(1-IF5)-ПАРАМЕТРЫ ТИПОВОЙ ПОВЕРХНОСТИ В
444 C  СООТВЕТСТВИИ С ТАБЛИЦЕЙ 2
445 C  READ 110,(F4(I),I=1,IF5)
446 C  CALL TELA(LPR)
447 C  10 CONTINUE
448 C  TW-ТЕМПЕРАТУРА ПОВЕРХНОСТИ ИСЗ
449 C  SM-ХАРАКТЕРНАЯ ПЛОЩАДЬ ИСЗ
450 C  DM-ХАРАКТЕРНЫЙ РАЗМЕР ИСЗ
451 C  READ 110,TW
452 C  READ 110,SM
453 C  READ 110,DM
454 C  CP(1-6)-ПЕРВНЕ ТРИ ЧИСЛА МИНИМАЛЬНЫЕ КООРДИ-
455 C  НАТЫ КН ПО ОСЯМ X1,X2,X3; СЛЕДУЮЩИЕ ТРИ
456 C  ЧИСЛА МАКСИМАЛЬНЫЕ КООРДИНАТЫ КН ПО ОСЯМ
457 C  X1,X2,X3
458 C  ST(1-9)-КООРДИНАТЫ ПО ОСЯМ X1,X2,X3 ТОЧЕК
459 C  (КОЛ-ВО НЕ БОЛЬШЕ 3)-ЦЕНТРОВ ТЯЖЕСТИ ИСЗ
460 C  READ 110,(CP(I),I=1,6)
461 C  NCT1=3,NCT
462 C  READ 110,(ST(I),I=1,NCT1)
463 C  KPT(1-24)-МАССИВ, КОТОРЫЙ ВВОДИТСЯ ПРИ LPR=1
464 C  И ЭЛЕМЕНТЫ КОТОРОГО РАВНЫ КОЛИЧЕСТВУ ПОВЕРХНОСТЕЙ
465 C  ВТОРОГО ПОРЯДКА В ПРОИЗВОЛЬНЫХ
466 C  ГРУППАХ, В КОТОРЫЕ ОБЪЕДИНЕНЫ ВСЕ ПОВЕРХНОСТИ
467 C  ВТОРОГО ПОРЯДКА ИСЗ

```

```

11 468      IF(LPR.EQ.1) READ 100,(KPR(I),I=1,24)
469      DO 21 I=1,50
470      FPR(I)=0
471      MD(I)=0
472      MD1(I)=0
473      21 MD2(I)=0
474      IF(KPR.EQ.0) GO TO 23
475 C   NPR-МАССЫВ, ЭЛЕМЕНТЫ КОТОРОГО РАВНЫ НОМЕРАМ
476 C   ПОВЕРХНОСТЕЙ.
477 C   MD1-МАССЫВ, ЭЛЕМЕНТЫ КОТОРОГО РАВНЫ КОЭФФИ-
478 C   ЦИЕНТАМ ПОРИСТОСТИ ДЛЯ СООТВЕТСТВУЮЩЕЙ ПО-
479 C   РИСТОЙ ПОВЕРХНОСТИ.
480 C   МАССИВЫ NPR И MD1 ВВОДЯТСЯ ПРИ KPR>0.
481      READ 100,(NPR(I),I=1,KPR)
482      READ 130,(MD1(I),I=1,KPR)
483      DO 22 I=1,N
484      DO 22 J=1,KPR
485      IF(I.EQ.NPR(J)) FPR(I)=MD1(J)
486      22 CONTINUE
487      PRINT 241,(FPR(I),I=1,N)
488      23 IF(KPR.EQ.0) GO TO 26
489 C   NPD-МАССЫВ, ЭЛЕМЕНТЫ КОТОРОГО РАВНЫ НОМЕРАМ
490 C   ОБЛАСТЕЙ ИСКЛЮЧЕНИЯ.
491 C   MD2-МАССЫВ, ЭЛЕМЕНТЫ КОТОРОГО РАСПОЛОЖЕНЫ
492 C   СООТВЕТСТВЕННО ЭЛЕМЕНТАМ NPD, А ЗНАЧЕНИЕ
493 C   ЭЛЕМЕНТА РАВНО НОМЕРУ ПОВЕРХНОСТИ, К КОТО-
494 C   РОМ ПРИНАДЛЕЖИТ СООТВЕТСТВУЮЩАЯ ОБЛАСТЬ
495 C   ИСКЛЮЧЕНИЯ.
496 C   МАССИВЫ NPD И MD2 ВВОДЯТСЯ ПРИ KPD>0.
11 497      READ 100,(NPD(I),I=1,KPD),(MD2(I),I=1,KPD)
498      DO 24 I=1,N
499      DO 24 J=1,KPD
500      IF(I.EQ.NPD(J)) MD(I)=MD2(J)
501      24 CONTINUE
502      DO 25 I=1,N
503      MD1(I)=0
504      25 MD2(I)=0
505      DO 26 I=1,N
506      DO 26 J=1,N
507      IF(MD(J).NE.1) GO TO 28
508      IF(MD1(I).NE.0) GO TO 27
509      MD1(I)=J
510      MD2(I)=J
511      GO TO 28
512      27 MD2(I)=MD2(I)+1
513      28 CONTINUE
514      PRINT 242,(MD(I),I=1,N)
515      PRINT 243,(MD1(I),I=1,N)
516      PRINT 244,(MD2(I),I=1,N)
517      26 IF(LBR.EQ.0) GO TO 29
11 518      READ 110,(XV(I),I=1,3),(OM(I),I=1,3)
519 C   ПАРАМЕТРЫ ЗАКОНОВ ОТРАЖЕНИЯ МОЛЕКУЛ ОТ ПОВЕРХ-
520 C   НОСТИ ИСЗ.
521 C   ПРИ ЗЕРКАЛЬНО-ДИФФУЗНОМ ОТРАЖЕНИИ И ОТРАЖЕНИИ
522 C   МОЛЕКУЛ В СООТВЕТСТВИИ С ФУНКЦИЕЙ МАКСВЕЛ-
523 C   ЛА ЗНАЧЕНИЯ ФУНКЦИИ FIE,FIN,FIT ЗАДАЮТСЯ
524 C   ПРИ ЗНАЧЕНИЯХ ЭНЕРГИИ МОЛЕКУЛ, РАВНЫХ
525 C   (В ЭВ):0.,.025,1.5,3.,4.5,6.,7.5,9.,10.5,

```

```

526 C 1000000. (ПО 10 ЧИСЕЛ ДЛЯ КАЖДОГО НОМЕРА (1-
527 C LKP) ЗАВИСИМОСТИ FIE, FIN, FIT),
528 C ЗНАЧЕНИЯ КОЭФФИЦИЕНТОВ АКОМОДАЦИИ ЭНЕРГИИ
529 C НОРМАЛЬНОГО И ТАНГЕНЦИАЛЬНОГО ИМПУЛЬСОВ
530 C (SIGE, SIGN, SIGT ЗАДАЮТСЯ ПРИ ЗНАЧЕНИЯХ УГ-
531 C ЛОВ ПАДЕНИЯ МОЛЕКУЛ К ПОВЕРХНОСТИ, РАВНЫХ
532 C (УГЛЫ В ГРАД.) 10., 20., 30., 40., 50., 60.,
533 C 70., 80., 90. ПО 10 ЧИСЕЛ ДЛЯ КАЖДОГО НОМЕРА
534 C (1-LKP) ЗАВИСИМОСТИ SIGE, SIGN, SIGT),
535 C ПРИ ОТРАЖЕНИИ МОЛЕКУЛ В СООТВЕТСТВИИ С ЛУЧЕ-
536 C ВОЙ МОДЕЛЬЮ ЗНАЧЕНИЯ FIE-УГЛОВ ОТРАЖЕНИЯ И
537 C SIGE-ОТНОШЕНИЯ СКОРОСТЕЙ ОТРАЖЕНИЯ И ПАДЕ-
538 C НИЯ МОЛЕКУЛ ЗАДАЮТСЯ ПРИ ЗНАЧЕНИЯХ УГЛОВ
539 C ПАДЕНИЯ МОЛЕКУЛ К ПОВЕРХНОСТИ, РАВНЫХ (УГЛЫ
540 C В ГРАД.) 10., 20., 30., 40., 50., 60., 70.,
541 C 80., 90. ПО 10 ЧИСЕЛ ДЛЯ КАЖДОГО НОМЕРА
542 C (1-LKP) ЗАВИСИМОСТИ FIE, SIGE),
543 C 20 IF (LOT, EQ, -1. OR, LOT, EQ, -4) GO TO 30
544 C 3 IF (LOT, NE, 1. AND, LOT, NE, 4) GO TO 5
545 C ДЛЯ ЗЕРКАЛЬНО-ДИФФУЗНОГО ОТРАЖЕНИЯ ЧАСТИЦ В
546 C ПОТОКЕ ГАЗА - ЛИ СВЕТ - ВВОДЯТСЯ ЗНАЧЕНИЯ
547 C КОЭФФИЦИЕНТА ДИФФУЗНОСТИ ОТРАЖЕНИЯ FIN,
548 C READ 100, (FIN(I), I=1, KRF)
549 C IF (KRF, NE, 1) GO TO 2
550 C DO 7 I=1, N
551 C 7 FIN(I)=FIN(I)
552 C 2 IF (LOT, NE, 1) GO TO 30
553 C ДЛЯ ЗЕРКАЛЬНО-ДИФФУЗНОГО ИЛИ ДЛЯ ЛУЧЕВОГО
554 C ОТРАЖЕНИЯ МОЛЕКУЛ ВВОДЯТСЯ FIE И SIGE,
555 C 4 READ 100, ((FIE(I, J), I=1, 10), (SIGE(I, J),
556 C I=1, 10), I=1, 10), (J=1, LKP)
557 C GO TO 6
558 C 5 IF (LOT, I, 2) GO TO 4
559 C ПРИ ОТРАЖЕНИИ МОЛЕКУЛ В СООТВЕТСТВИИ С ФУНК-
560 C ЦИЕЙ МАКГВЕЛЛА ВВОДЯТСЯ FIE, FIN, FIT,
561 C SIGE, SIGN, SIGT,
562 C READ 100, ((FIE(I, J), I=1, 10), J=1, LKP),
563 C ((FIN(I, J), I=1, 10), J=1, LKP), ((FIT(I, J), I=
564 C 1, 10), J=1, LKP), ((SIGE(I, J), I=1, 10), J=1,
565 C LKP), ((SIGN(I, J), I=1, 10), J=1, LKP),
566 C ((SIGT(I, J), I=1, 10), J=1, LKP)
567 C MN(1-N)-МАССИВ, КОТОРЫИ ВВОДИТСЯ ПРИ LKP>1 И
568 C ЭЛЕМЕНТЫ КОТОРОГО РАСПОЛОЖЕНЫ В СООТВЕТСТ-
569 C ВИИ С НОМЕРАМИ ПОВЕРХНОСТЕЙ ВТОРОГО ПОРЯД-
570 C КА, А ЗНАЧЕНИЯ РАВНЫ НОМЕРАМ ЗАВИСИМОСТЕЙ
571 C ПАРАМЕТРОВ ЗАКОНОВ ОТРАЖЕНИЯ МОЛЕКУЛ ДЛЯ
572 C СООТВЕТСТВУЮЩЕЙ ПОВЕРХНОСТИ ВТОРОГО ПОРЯД-
573 C КА ИСЗ.
574 C 6 IF (LKP, NE, 1) READ 100, (MN(I), I=1, IF)
575 C 30 IF (LPR, EQ, 0) GO TO 31
576 C READ 100, (MKN(I), I=1, 12), (W1(I), I=1, 12), (W
577 C 2(I), I=1, 12), (W3(I), I=1,
578 C *12)
579 C 31 PRINT 230, TW, SM, DM, CP, (CT(I), I=1, NCT1)
580 C IF (LPR, EQ, 0) GO TO 40
581 C PRINT 240, (KPT(I), I=1, 24)
582 C 40 PRINT 250
583 C IF (LOT, NE, -1) GO TO 50

```



```

583 PRINT 260
584 50 IF(LOT.NE.1) GO TO 60
585 PRINT 270,(FIN(I),I=1,N)
586 PRINT 280,(FIF(I,J),I=1,10),J=1,LKP)
587 PRINT 290,(SIGE(I,J),I=1,10),J=1,LKP)
588 60 IF(LOT.NE.2) GO TO 70
589 PRINT 300
590 PRINT 280,(FIE(I,J),I=1,10),J=1,LKP)
591 PRINT 310,(FIN(I,J),I=1,10),J=1,LKP)
592 PRINT 320,(FJT(I,J),I=1,10),J=1,LKP)
593 PRINT 290,(SIGE(I,J),I=1,10),J=1,LKP)
594 PRINT 330,(SIGN(I,J),I=1,10),J=1,LKP)
595 PRINT 340,(SIGT(I,J),I=1,10),J=1,LKP)
596 70 IF(LOT.NE.3) GO TO 80
597 PRINT 350
598 PRINT 280,(SJJF(I,J),I=1,10),J=1,LKP)
599 PRINT 290,(SIGF(I,J),I=1,10),J=1,LKP)
600 80 IF(LKP.EQ.1) GO TO 90
601 PRINT 360,(MN(I),I=1,IF)
602 100 FORMAT(24I3)
603 110 FORMAT(6E12,4)
604 120 FORMAT(7I10)
605 130 FORMAT(10E7,4)
606 140 FORMAT('КОЛИЧЕСТВО ТИПОВЫХ ПОВЕРХНОСТЕЙ ИС-
        3 КТ=I3)
607 150 FORMAT(//,20X,'НАЧАЛЬНЫЕ ДАННЫЕ (ПРОГРАММА
        МА3)',//)
608 160 FORMAT(1X,'NA,NB,NH,NCJ,LOT,LKP,LPR,LH,KPR
        ,KPD,KDF,KKG,IPQ,LBR,,2X
609 * ,14I3)
610 170 FORMAT(1X,'NR,KD,,5X,2I10)
611 180 FORMAT(1X,'AL,,5X,9E13,5)
612 190 FORMAT(1X,'BE,,5X,9E13,5)
613 200 FORMAT(1X,'H,,5X,9E13,5)
614 220 FORMAT(//,20X,'ПАРАМЕТРЫ ПОВЕРХНОСТЕЙ (ТИПО-
        Вых и второго порядка)
615 *ИСЗ',//)
616 230 FORMAT(1X,'TW,,5X,E14.5,15X,'SM,,5X,E14.5,
        15X,'DM,,5X,E14.5/
617 *1X,'CP',5X,E14.5/1X,'ST',5X,9E13,5)
618 240 FORMAT(1X,'KPT',5X,24I3)
619 241 FORMAT(1X,'КОЭФФИЦИЕНТЫ ПОРИСТОСТИ',2X,10E
        10,4)
620 242 FORMAT(1X,'НОМЕРА ПОВ-и 2-ГО ПОРЯДКА, КОТОР-
        ым принадлежат соответст
621 *ВЧЮЩИЕ ЯСТИ ИСКЛЮЧЕНИЯ',/1X,42I3)
622 243 FORMAT(1X,'НАЧАЛ ИМЕ НОМЕРА ОБЛАСТЕЙ ИСКЛЮ-
        чения соответствующей по
623 *ВЕРХНОСТИ 2-ГО ПОРЯДКА',/1X,42I3)
624 244 FORMAT(1X,'КОНЕЧНЫЕ НОМЕРА ОБЛАСТЕЙ ИСКЛЮ-
        чения соответствующей пов
625 *ЕРХНОСТИ 2-ГО ПОРЯДКА',/1X,42I3)
626 250 FORMAT(//,20X,'ПАРАМЕТРЫ ЗАКОНОВ ОТРАЖЕНИЯ
        МОЛЕКУЛ',//)
627 260 FORMAT(1X,'ЗЕРКАЛЬНОЕ ОТРАЖЕНИЕ МОЛЕКУЛ ОТ
        ПОВЕРХНОСТИ'
628 270 FORMAT(1X,'ЗЕРКАЛЬНО-ДИФФУЗНОЕ ОТРАЖЕНИЕ',
        /1X,'FIN',1X,10E12,4)
629 280 FORMAT(1X,'FIE',3X,10E12,4)

```

```

630 290 FORMAT(1X,'SIGE',2X,10E12,4)
631 300 FORMAT(1X,'ОТРАЖЕНИЕ МОЛЕКУЛ ОТ ПОВЕРХНОСТ
      И В СООТВЕТСТВИИ С
632 *ФУНКЦИЕЙ МАКСВЕЛЛА*)
633 310 FORMAT(1X,'FIN',3X,10E12,4)
634 320 FORMAT(1X,'FIT',3X,10E12,4)
635 330 FORMAT(1X,'SIGN',2X,10E12,4)
636 340 FORMAT(1X,'SIGT',2X,10E12,4)
637 350 FORMAT(1X,'ОТРАЖЕНИЕ МОЛЕКУЛ ОТ ПОВЕРХНОСТ
      И В СООТВЕТСТВИИ С
638 *ПЛУЧЕВОЙ МОДЕЛЬЮ*)
639 360 FORMAT(1X,'MM',5X,24I3)
640 90 RETURN
641 END
642 SUBROUTINE TELA(LPR)
643 DIMENSION INFT(100),B(3,3),B4(3)
644 COMMON /BL1/D(4,50),INFP(50)/BL2/A(3,3,50)
      ,A4(3,50),A44(50)
645 1/BL3/ΔK(3,3,50),X0(3,50)
646 COMMON/BLT/T1(3),T2(3),T3(3),T4(3),T5(3),T
      6(3),T7(3),T8(3),
647 1T9(3)/BLC/C0(3),C1(3),C2(3),C3(3)/RE
      S2/KPT(30),NT,N,N1,N2,
648 2P1P2(2),TEL(108)
649 INTEGER P1P2
650 DATA P1,GR/3 14159265,0,0174532925/
651 ITO=N+1
652 INFT(N1)=P1P2(1)
653 INFT(N1+1)=P1P2(2)
654 M=INFT(N1)
655 GO TO (6,16,17,20,24,23,25,60),M
656 6 CALL WY(12)
657 N1=N1+2
658 CALL PERES(T1,T2,T3)
659 IF((TEL(10)-RAST(T1,T2)).GE.0.) TEL(10)=RA
      ST(T1,T2)
660 IF (TEL(11).NE.0) GO TO 8
661 IF(ABS(RAST(T1,T2)-TEL(10)).LE.1.E-2) GO T
      O 7
662 CALL TRAP(T1,T2,T3,TEL(10),N)
663 GO TO 42
664 7 CALL PARAL(T1,T2,T3,N)
665 GO TO 42
666 8 CALL NORMAL(T1,T2,T3,C1)
667 CALL NCOS(T1,T2,C2)
668 DO 9 I=1,3
669 R1=C1(I)*TEL(11)/2
670 R2=C1(I)*TEL(12)/2
671 T1(I)=T1(I)-R1
672 T2(I)=T2(I)-R1
673 T3(I)=T3(I)-R2
674 T5(I)=TEL(I)+R1
675 T6(I)=TEL(I+3)+R1
676 T7(I)=TEL(I+6)+R2
677 9 T8(I)=T7(I)+C2(I)*TEL(10)
678 IF(ABS(RAST(T1,T2)-TEL(10))-1.E-2) 10,10,1
      1
679 10 CALL PARAL(T1,T2,T3,N)
680 CALL PARAL(T5,T6,T7,N)

```

```

681      GO TO 12
682      11 CALL TPAP(T1,T2,T3,TEL(10),N)
683      CALL TRAP(T5,T6,T7,TEL(10),N)
684      12 IF(TEL(11).EQ,TEL(12)) GO TO 13
685      CALL TPAP(T1,T5,T3,TEL(12),N)
686      CALL TRAP(T6,T2,T8,TEL(12),N)
687      GO TO 14
688      13 CALL PAPAN(T1,T5,T3,N)
689      CALL PARAL(T6,T2,T8,N)
690      14 IF(INFT(N1-1).EQ,3.OR,INFT(N1-1).EQ,4) GO
        TO 15
691      CALL PARAL(T1,T2,T5,N)
692      15 IF(INFT(N1-1).EQ,2.OR,INFT(N1-1).EQ,4.OR,TEL(12).EQ,0) GO TO 42
693      CALL PARAL(T7,T8,T3,N)
694      GO TO 42
695      16 CALL WV(12)
696      N1=N1+2
697      CALL PERES(T1,T2,T3)
698      CALL KOLCO(T1,T2,T3,TEL(10),TEL(11)*GR,TEL(12)*GR,N)
699      GO TO 42
700      17 CALL WV(13)
701      N1=N1+2
702      CALL PERES(T1,T2,T3)
703      R1=TEL(12)*GR
704      R2=TEL(13)*GR
705      CALL CIL(T1,T2,T3,TEL(10),TEL(11),R1,R2,N)
706      IF(INFT(N1-1).EQ,3.OR,INFT(N1-1).EQ,4) GO
        TO 18
707      CALL KOLCO(T1,T2,T3,0,R1,R2,N)
708      18 IF(INFT(N1-1).EQ,2.OR,INFT(N1-1).EQ,4) GO
        TO 42
709      CALL NORMAL(T1,T2,T3,C1)
710      CALL NCOS(T1,T2,C2)
711      CALL NCOS(T1,T3,C3)
712      DO 19 I=1,3
713      T4(I)=T1(I)+TEL(10)+C1(I)+TEL(11)+C2(I)
714      T5(I)=T4(I)+PAST(T1,T2)*C2(I)
715      19 T6(I)=T4(I)+RAST(T1,T3)*C3(I)
716      CALL KOLCO(T4,T5,T6,0,R1,R2,N)
717      GO TO 42
718      20 CALL V(14)
719      N1=N1+2
720      CALL PERES(T1,T2,T3)
721      R1=TEL(13)*GR
722      R2=TEL(14)*GR
723      CALL CONUS(T1,T2,T3,TEL(10),TEL(11),TEL(12),R1,R2,N)
724      IF(INFT(N1-1).EQ,3.OR,INFT(N1-1).EQ,4) GO
        TO 21
725      CALL KOLCO(T1,T2,T3,0,R1,R2,N)
726      21 IF(INFT(N1-1).EQ,2.OR,INFT(N1-1).EQ,4.OR,TEL(12).EQ,0) GO TO 42
727      CALL NORMAL(T1,T2,T3,C1)
728      CALL NCOS(T1,T2,C2)
729      CALL NCOS(T1,T3,C3)
730      R3=RAST(T1,T3)*TEL(12)/RAST(T1,T2)

```

```

731      DO 22 I=1,3
732      T4(I)=T1(I)+TEL(10)*C1(I)+TEL(11)*C2(I)
733      T5(I)=T4(I)+TEL(12)*C2(I)
734      22 T6(I)=T4(I)+P3*C3(I)
735      CALL KOLCO(T4,T5,T6,0,R1,R2,N)
736      GO TO 42
737      23 CALL WV(14)
738      N1=N1+2
739      CALL PERES(T1,T2,T3)
740      CALL ELIPS(T1,T2,T3,TEL(10),TEL(11)*GR,TEL
              (12)*GR,TEL(13)*GR,TEL(1
741      14)*GR,N)
742      GO TO 42
743      24 CALL WV(14)
744      N1=N1+2
745      CALL PERES(T1,T2,T3)
746      CALL PARAB(T1,T2,T3,TEL(10),TEL(11),TEL(12)
              )*GR,TEL(13)*GR,TEL(14)
747      1,N)
748      IF(INFT(N-1).EQ.3.OR.INFT(N1-1).EQ.4) GO T
              O 50
749      CALL KOLCO(T1,T2,T3,0,TEL(12)*GR,TEL(13)*G
              R,N)
750      50 IF(INFT(N-1).EQ.2.OR.INFT(N-1).EQ.4.OR.TEL
              (10).EQ.TEL(14))GO TO 42
751      CALL NORMAL(T1,T2,T3,C1)
752      CALL NCOS(T1,T2,C2)
753      CALL NCOS(T1,T3,C3)
754      R1=RAS(T1,T2)*SQRT(1-TEL(14)/TEL(10))
755      R2=RAS(T1,T3)*SQRT(1-TEL(14)/TEL(10))
756      DO 51 I=1,3
757      T4(I)=T1(I)+TEL(10)*C1(I)+TEL(11)*C2(I)
758      T5(I)=T4(I)+R1*C2(I)
759      51 T6(I)=T4(I)+R2*C3(I)
760      CALL KOLCO(T4,T5,T6,0,TEL(12)*GR,TEL(13)*G
              R,N)
761      GO TO 42
762      25 CALL WV(6*2*INFT(N1-1))
763      N1=N1+2
764      IF(TEL(4))27,26,27
765      26 C2(1)=1.
766      C2(2)=0
767      GO TO 28
768      27 C2(2)=1/SQRT(1+(TEL(5)/TEL(4))*2)
769      C2(1)=-TEL(5)/TEL(4)*C2(2)
770      28 C2(3)=0.
771      CALL PERES(T4,C1,T5)
772      CALL VVECTOR(C1,C2,C3)
773      NWV=4+2*INFT(N1-1)
774      DO 41 J=7*NWV,2
775      IF(TEL(J+2)-TEL(J)) 32,29,32
776      29 R2=AMAX1(TEL(J+1),TEL(J+3))
777      R3=AMIN1(TEL(J+1),TEL(J+3))
778      DO 30 J=1,3
779      T1(J)=T4(J)+TEL(J)*C1(J)
780      T2(J)=T1(J)+R2*C2(J)
781      30 T3(J)=T1(J)+R3*C3(J)
782      IF(TEL(J+1).LT.TEL(J+3)) GO TO 31

```

```

783 CALL KULCO(T1,T2,T3,R3,0.2*pI,N)
784 GO TO 41
785 31 CALL KULCO(T1,T3,T2,R3,0.2*pI,N)
786 GO TO 41
787 32 IF(TEL(I+1)-TEL(I+3)) 35,33,37
788 DO 34 J=1,3
789 T1(J)=T4(J)+AMIN1(TEL(I),TEL(I+2))*C1(J)
790 T2(J)=T1(J)+TEL(I+1)*C2(J)
791 34 T3(J)=T1(J)+TEL(I+1)*C3(J)
792 CALL CIL(T1,T2,T3,ABS(TEL(I+2)-TEL(I)),0.0
,2*pI,N)
793 GO TO 41
794 35 DO 36 J=1,3
795 T1(J)=T4(J)+TEL(I+2)*C1(J)
796 T3(J)=T1(J)+TEL(I+3)*C2(J)
797 36 T2(J)=T1(J)+TEL(I+3)*C3(J)
798 GO TO 39
799 DO 38 J=1,3
800 T1(J)=T4(J)+TEL(I)*C1(J)
801 T2(J)=T1(J)+TEL(I+1)*C2(J)
802 38 T3(J)=T1(J)+TEL(I+1)*C3(J)
803 39 IF(TEL(I)-TEL(I+2),GT,0) GO TO 40
804 CALL CONUS(T1,T2,T3,ABS(TEL(I)-TEL(I+2))*0
,AMIN1(TEL(I+1),TEL(I+3))
,0.2*pI,N)
805 GO TO 41
806 40 CALL CONUS(T1,T3,T2,ABS(TEL(I)-TEL(I+2))*0
,AMIN1(TEL(I+1),TEL(I+3))
,0.2*pI,N)
807 GO TO 41
808 41 CONTINUE
809 GO TO 42
810 42 CALL WV(24)
811 I=I+2
812 A=A+1
813 NC=61+I-3
814 B(1,1)=TEL(I)
815 B4(I)=TEL(I+6)
816 X(1,1)=TEL(I+10)
817 C(1,1)=TEL(I+13)
818 C2(1)=TEL(I+16)
819 AK(1,1,N)=C1(I)
820 41 AK(2,1,N)=C2(I)
821 B(1,2)=TEL(4)
822 B(2,3)=TEL(5)
823 B(3,1)=TEL(6)
824 B(2,1)=B(1,2)
825 B(3,2)=B(2,3)
826 B(1,3)=B(3,1)
827 B44=TEL(10)
828 CALL VECTOR(C1,C2,C3)
829 DO 52 I=1,3
831 52 AK(3,I,N)=C3(I)
832 CALL PERMX(B,B4,B44,N)
833 DO 53 I=1,4
834 53 D(I,N)=TEL(I+19)
835 INP(N)=(TEL(24)+0.1)
836 42 IF(LPR,FQ,0) GO TO 70
837 DO 43 IT=IT0,N

```



```

838 43 PRINT 44, IT, ((A(J, K, IT), D=1, 3), K=1, 3), (A4(
      J, IT), J=1, 3), A44(IT), ((
839 1AK(J, K, IT), K=1, 3), J=1, 3), (X0(I, IT), J=1, 3),
      INFR(IT), (D(J, IT), J=1, 4)
840 44 FORMAT(/ 'НОМЕР ПОВЕРХНОСТИ 2-ГО ПОРЯДКА NR
      =', I3/
841 1 'КОЭФИЦИЕНТЫ УРАВНЕНИЯ ПОВЕРХНОСТИ ΔIK(9)
      , A74(I3), A44(I1) ОТНОСИТЕЛ
842 2 'НО ОСЕЙ X1'/X, 9E14, 6/X, 3E14, 6, 14X, E14, 6/
843 3 'НАПРАВЛЯЮЩИЕ КОСИНУСЫ ΔJI МЕСТНОЙ СИСТЕМЫ
      КООРДИНАТ ΔJ'/Y, 9E14, 6/
844 4 'КООРДИНАТЫ X0I ТОЧКИ У МЕСТНОЙ СИСТЕМЫ КО
      ОРДИНАТ ΔJ', 9X, 3E14, 6/
845 5 'ПРИЗНАК P СИСТЕМЫ КООРДИНАТ ЗАДАНИЕ ОБЛАС
      ТИ D', I3/
846 6 'ПРЕДЕЛЫ ОБЛАСТИ D ОПРЕДЕЛЕНИЯ ПОВЕРХНОСТИ
      ', 5X, 4E14, 6/)
847 70 RETURN
848
849 SUBROUTINE RESULT(LPP) END
850 DIMENSION E4(50), S4(3, 50), CM4(3, 50), CC(3, 3
      ), CI(3)
851 COMMON/RES1/ AL(18), BE(18), H(9), LOT, LUD, VB
      , TB, SW, TW, NRT, NR
852 *NS, KSS, AD, DM, NCT, IA, TB, TH, F1(50), F(50), E3
      (50), S1
853 2(3, 50), S2(3, 50), S3(3, 50), CM1(3, 50), CM2(3, 5
      0), CM3(3, 50), C5(3), CM5(3
854 3), E5, CT(3, 3), AN(24), MN(6), MN(24, 6), TB4(24
      ), VP4(24), NH, NB, TA, XD
855 4LPR, NR1, NR2, SM, CP(6)/RES2/KOT(30), A*, N, N1
      , N2, P1P2(2)*TFI(108)
856 */BL7/HW, MU, FN12, SB, NB, OPTN(3), RC, RS
857 5/BLT/*1(3), T2(3), T3(3), T4(3), T5(3), T6(3), T
      7(3), T8(3), T9(3)
858 6/BLG/CO(3), C1(3), C2(3), C3(3), C4(3)
859 */ALP2/SIN(3), S1T(3), CM1N(3), CM1T(3), S2N(3)
      , CM2N(3), S1AR(3), S1TB(3)
860 *, CM1NB(3), CM1TB(3), S2NB(3), S2TB(3), CM2NB(3)
      , CM2TB(3), S2T(3), CM2T(3)
861 *)
862 */BLP1/LPO, LPP, OM(3), XR(3)
863 */BLP3/HKN(12), W(12), W2(12), W3(12)
864 RFAI MU, MUH
865 INTEGR P1P2
866 DATA CG 0.0174532925, CI, -1., 1., 1., /
867 R1=NS*1./NR*
868 R2=0,
869 1F(NS, NF, 0) P2=KSS*1./NS
870 IF(LR, EQ 0 GO TO 2
871 PRINT 1, AL(TA), MU, AF(IP), SB, H(I-1), S, LOT
      , RT, LPP, P1, VB, P2, TB, T
872 *TW, N
873 1 FORMAT(/ 'УГОЛ АТАКИ', 15X, F10, 4, 20X, 'МОЛЕКУ
      ЛАРНЫЙ ВЕС ГАЗА', 19X,
874 *E10, 4, 'УГОЛ СКОЛЬЖЕНИЯ', 10X, F10, 4, 20X, 'СКО
      РОСТНОЕ ОТНОШЕНИЕ SB'

```

```

875 *17X,E10,4/'ВЫСОТА ПОЛЕТА',12X,E10,4,20X,'С
      КОРОСТНОЕ ОТНОШЕНИЕ SW',
876 *17X,E10,4/'ПРИЗНАК ЗАКОНА ОТРАЖЕНИЯ',1X,E1
      0,4,20X,'КОЛИЧЕСТВО СЛУЧ
877 *АИНЫХ ТРАЕКТОРИЙ МОЛЕКУЛ',2X,E10,4/'ПРИЗНА
      К ПЕЧАТИ',11X,E10,4,20X,
878 *,'ВЕРОЯТНОСТЬ ПЕРЕСЕЧЕНИЯ ТРАЕКТОРИИ С ИСЗ,
      ,E10,4/'СКОРОСТЬ ПОТОКА'
879 *,'10X,E10,4,20X,'СРЕДНЕЕ ЧИСЛО СТОЛКНОВЕНИЯ
      В ТРАЕКТОРИИ',1X,E10,4/
880 *,'ТЕМПЕРАТУРА ПОТОКА',7X,E10,4,20X,'КОЛИЧЕ
      СТВО ТИПОВЫХ ПОВЕРХНОСТЕЙ
881 *,'9X,E10,4/'ТЕМПЕРАТУРА ПОВЕРХНОСТИ',2X,E1
      0,4,20X,'КОЛИЧЕСТВО ПОВЕ
882 *РХНОСТЕЙ 2-ГО ПОРЯДКА',4X,E10,4)
883 2 R5=1./NR
884 R6=R5/DM
885 R7=R5/2/VB
886 DO 78 J=1,N
887 E1(J)=E1(J)*R7
888 E2(J)=E2(J)*R7
889 E3(J)=E3(J)*R7
890 E4(J)=E1(J)+E2(J)+E3(J)
891 DO 78 I=1,3
892 S1(I,J)=S1(I,J)*R5
893 S2(I,J)=S2(I,J)*R5
894 S3(I,J)=S3(I,J)*R5
895 S4(I,J)=S1(I,J)+S2(I,J)+S3(I,J)
896 CM1(I,J)=CM1(I,J)*R6
897 CM2(I,J)=CM2(I,J)*R6
898 CM3(I,J)=CM3(I,J)*R6
899 78 CM4(I,J)=CM1(I,J)+CM2(I,J)+CM3(I,J)
900 IF(LRP,ER,0) GO TO 86
901 K=1
902 K1=0.
903 K2=KPT(1)
904 DO 85 J=1,N
905 S1(1,J)=-S1(1,J)
906 S2(1,J)=-S2(1,J)
907 S3(1,J)=-S3(1,J)
908 S4(1,J)=-S4(1,J)
909 PRINT '9,0,J
910 79 FORMAT(I1,'НОМЕР ПОВЕРХНОСТИ 2-ГО ПОРЯДКА'
      ,15)
911 PRINT 80
912 80 FORMAT(29X,'CX',13X,'CY',13X,'CZ',13X,'MX',
      ,13X,'MY',13X,'MZ',13X,
913 1'CE')
914 PRINT 81,(S1(I,J),I=1,3),(CM1(I,J),I=1,3),
      E1(J),(S2(I,J),I=1,3),
915 1(CM2(I,J),I=1,3),E2(J),(S3(I,J),I=1,3),(CM
      3(I,J),I=1,3),E3(J),
916 2(S4(I,J),I=1,3),(CM4(I,J),I=1,3),F4(J)
917 81 FORMAT('ПЕРВОЕ СТОЛКНОВЕНИЕ',X,7E15,4/'ПЕР
      ВОЕ ОТРАЖЕНИЕ',4X,7E15,4
918 1/'ПОВТОРНЫЕ СТОЛКНОВ.',1X,7E15,4/'СУММА',1
      5X,7E15,4)
919 IF(J.NE,K2) GO TO 85

```



```

077      T4(1)=T4(1)+S4(1)*T1
078      T5(1)=T5(1)+GM1(1)*T1
079      T6(1)=T6(1)+GM2(1)*T1
080      T7(1)=T7(1)+GM3(1)*T1
081      88 T8(1)=T8(1)+GM4(1)*T1
082      DO 89 I=-3
083      C1(1)=SQRT((S5(1)/NR-T4(1)*T4(1))/NR)
084      89 C2(1)=SQRT((GM5(1)/NR-DM-DM-T8(1)*T8(1))/NR)
085      CD=SQRT((E5/4/NR-R4*R4)/NR)
086      IF(LR0, EQ, 0) GO TO 14
087      T1(1)=-T1(1)
088      T2(1)=-T2(1)
089      T3(1)=-T3(1)
090      T4(1)=-T4(1)
091      14 PRINT 90
092      90 FORMAT('///СУММАРНЫЕ ДЭРОДИНАМИЧЕСКИЕ ХАРАК-
          ТЕРИСТИКИ'//
          ' СВЯЗАННАЯ СИСТЕМА КООРДИНАТ'//)
093      PRINT 80
094      PRINT 81 '1, T5, R1, T2, T6, R2, T3, T7, R3, T4, T8,
          R4
095      PRINT 91 C1, C2, CD
096      91 FORMAT('СР. КБ. ОТКЛОНЕНИЯ', 2X, 7E15, 4//)
097      T4(1)=-T4(1)
098      DO 94 I=-3,NLT
099      DO 92 I=-3
1000
1001      92 C3(1)=C2(1)*I2)
1002      CALL VECTOR(T4, C1, C2)
1003      DO 93 I=-3
1004      93 T9(1)=T8(1)+C2(1)/DM
1005      94 PRINT 95, C1, T9
1006      95 FORMAT('КООРДИНАТЫ ЦЕНТРА ТЯЖЕСТИ X=', E9, 3
          , 3X, 'Y=', E9, 3, 3X, 'Z=',
          *E9, 3, 5E, 5, 4)
1007      R1=COS(AL(1A))*GR)
1008      R2=SIN(AL(1A))*GR)
1009      R3=COS(AB(1B))*GR)
1010      R4=SIN(AB(1B))*GR)
1011      CC(1,1)=R1*R3
1012      CC(1,2)=-R2*R3
1013      CC(1,3)=R4
1014      CC(2,1)=R4
1015      CC(2,2)=R2
1016      CC(2,3)=R1
1017      CC(3,1)=0
1018      CC(3,2)=-R1*R4
1019      CC(3,3)=R2*R4
1020      CC(3,3)=R3
1021      CALL PP(T4, CD, CC, T1, 1)
1022      CALL PP(T8, CD, CC, T2, 1)
1023      T1(1)=-T1(1)
1024      PRINT 96
1025      96 FORMAT('///СКОРОСТНАЯ СИСТЕМА КООРДИНАТ'//)
1026      PRINT 80
1027      PRINT 97, T1, T2
1028      97 FORMAT('20X, 5E15, 4)
1029      IF(LP0, EQ, 0) GO TO 25
1030      PRINT 20

```

```

1031 20 FORMAT(//АЭРОДИНАМИЧЕСКИЕ КОЭФФИЦИЕНТЫ В С
        ВЯЗАННОЙ СИСТЕМЕ КООРДИН
1032 *АТ В ПЕРЕХОДНОЙ ОБЛАСТИ//)
1033 PRINT 23
1034 23 FORMAT(,13X, 'МКН',13X, 'СХ',13X, 'СУ',13X, 'СZ
        ,13X, 'МХ',13X, 'МУ',13X,
1035 *М7')
1036 UO 21 I=1,12
1037 DO 27 J=1,3
1038 T1(J)=(W1(I)*S2N(J)+W2(I)*S1N(J)+W3(I)*S1T
        (J))+R5*CT(J)
1039 27 T2(J)=(W1(I)*CM2N(J)+W2(I)*CM1N(J)+W3(I)*C
        M1T(J))+R6
1040 PRINT 24,МКН(I),T1,T2
1041 24 FORMAT(,2X,E15,4,3X,6E15,4)
1042 21 CONTINUE
1043 25 IF(LBR.EQ.0) GO TO 32
1044 R7=R5*V/RAS(CO,OM)/DM
1045 PRINT 26
1046 26 FORMAT(//ПРОИЗВОДНЫЕ АЭРОДИНАМИЧЕСКИХ КОЭФ
        ФИЦИЕНТОВ В СВЯЗАННОЙ СИ
1047 *СТЕМЕ КООРДИНАТ ПО БЕЗРАЗМЕРНОЙ УГЛОВОЙ СК
        ОРОСТИ ИСЗ//)
1048 PRINT 27
1049 27 FORMAT(,12X, 'МКН',12X, 'СХОМ',11X, 'СУОМ',11X
        , 'СЗОМ',11X, 'МХОМ',11X, '
1050 *МУОМ',11X, 'МЗОМ')
1051 IF(LPO.NE.0) GO TO 29
1052 DO 28 I=1,3
1053 T1(I)=(S2NB(I)-S2N(I)+S1NB(I)-S1N(I)+S1TB(I)
        -S1T(I)+S2TB(I)-S2T(I)
1054 *I+R7*CI(I)
1055 28 T2(I)=(CM2NB(I)-CM2N(I)+CM1NB(I)-CM1N(I)+C
        M1TB(I)-CM1T(I)+CM2TB(I)
1056 *-CM2T(I))+R7/DM
1057 PRINT 27,T1,T2
1058 GO TO 32
1059 29 DO 31 I=1,12
1060 DO 30 J=1,3
1061 T1(J)=(W1(I)*(S2NB(J)-S2N(J))+W2(I)*(S1NB(J)
        -S1N(J))+W3(I)*(S1TB(J)
1062 *-S1T(J))+R7*CI(J)
1063 30 T2(J)=(W1(I)*(CM2NB(J)-CM2N(J)+W2(I)*(CM1
        NB(J)-CM1N(J))+W3(I)*(CM
1064 *1TB(J)-CM1T(J))+R7/DM)
1065 PRINT 24,МКН(I),T1,T2
1066 31 CONTINUE
1067 32 RETURN
1068 END
1069 SUBROUTINE OTR (X,V,N,M)
1070 COMMON/BL4/A(3,3,50),A4(3,50),A44(50)/BLC/
        CO(3),C1(3),C2(3),O3(3),
1071 C4(3)/BL7/HW,MU,FM12,SB,HB,ORTN,R1,ST
1072 /ALVO/LKP,FD,FIE,FIN,FIT,SIGE,SIGN,SIGT,MN
1073 /BLP1/LPO,LBR,DM(3),XB(3)
1074 REAL M
1075 DIMENSION X(3),V(3),ORTN(3),AE(10),AT(10),
        FE(27),FSR3(27),FIE(10,5

```



```

1076 1) FIN(10,5),FIT(10,5),SIGE(10,5),SIGN(10,5
      ),SIGT(10,5),MN(50),
1077 2)FEI(10),FNT(10),FTI(10),SEI(10),SNI(10),ST
      I(10)
1078 EXTERNAL P2
1079 DATA L/O/P1/3.141592657,GR/.017453292/,
1080 1)AE/O/.,.025,1.5,3.,4.5,6.,7.5,9.,10.5,10000
      00./,
1081 2)AT/O/.,.1736,.,347,.,5,.,6428,.,766,.,866,.,9397,
      .9848,1./,
1082 3)E/.00057,.,0117,.,0146,.,0187,.,0247,.,034,.,04
      27,.,0615,.,077,.,1,.,128,
1083 4,1665,.,2226,.,2977,.,3927,.,506,.,609,.,702,.,77
      36,.,834,.,877,.,9,.,9198,
1084 5,934,.,9458,.,953,.,9612/,
1085 6)FSR3/-10,.,-9,.,-8,.,-7,.,-6,.,-5,.,-4,.,-3.5,-3.
      ,-,2.5,-2,.,-1.5,-1,.,-.5,
1086 70,.,.5,1,.,1.5,2,.,2.5,3,.,3.5,4,.,4.5,5,.,5.5,6
      /
1087 CALL OPT(X,ORTN,N)
1088 CALL GIST(V)
1089 IF(IABS(M),NE,1,AND,IABS(M),NE,4) GO TO 13
1090 IF(M,NE,-1,AND,M,NE,-4) GO TO 5
1091 3 DO 4 I1=1,3
1092 4 V(I1)=V(I1)-2*R1*ORTN(I1)
1093 RETURN
1094 5 IF(PNDM(-1),LE,FIN(N)) GO TO 13
1095 GO TO 3
1096 13 K=1
1097 GO TO(23,26,38,23),M
1098 23 R2=2*PI*RNDR(-1)
1099 R3=SQRT(RNDR(-1))
1100 C4(1)=COS(R2)*R3
1101 C4(2)=SIN(R2)*R3
1102 C4(3)=SQRT(1-R3**2)
1103 DO 24 I3=1,3
1104 24 V(I3)=C1(I3)*C4(1)+C2(I3)*C4(2)+C3(I3)*C4(
      3)
1105 IF(M,NE,4) GO TO 27
1106 RETURN
1107 27 IF(LKP,NE,1) K=MN(N)
1108 E1=MU*(VM**2)/.1927056E9
1109 DO 25 J=1,10
1110 FEI(J)=FIF(J,K)
1111 25 SEI(J)=SIGE(J,K)
1112 ALE=1-INTR(E1,AE,FEI,10,FALSE)*(1-AINTR(S
      T,AT,SEI,10,FALSE))
1113 HR=ALE*HM**2+VM**2*(1-ALE)/2
1114 VM=SQRT(-HR*ALOG(RNDR(-1)*RNDR(-1)))
1115 RETURN
1116 26 IF(LKP,NE,1) K=MN(N)
1117 E1=MU*(VM**2)/.1927056E9
1118 DO 31 J=1,10
1119 FEI(J)=FIF(J,K)
1120 FNI(J)=FIN(J,K)
1121 FTI(J)=FIT(J,K)
1122 SEI(J)=SIGE(J,K)
1123 SNI(J)=SIGN(J,K)
1124 31 STI(J)=SIGT(J,K)

```

```

1125 ALE=1-AINTR(EI,AE,FEI,10,FALSE)*(1-AINTR(
      T,AT,SFI,10,FALSE))
1126 ALN=1-AINTR(EI,AE,FNI,10,FALSE)*(1-AINTR(
      T,AT,SFI,10,FALSE))
1127 ALT=1-AINTR(EI,AE,FTI,10,FALSE)*(1-AINTR(
      T,AT,STI,10,FALSE))
1128 R2=(1-ALE)*VM**2+ALE*2*HW**2
1129 R3=(1-ALN)*ABS(R1)*VM+ALN*SQRT(P1)*HW/2
1130 R4=(1-ALT)*ST*VM
1131 R5=R3**2/(R2-R4**2)
1132 IF(R5,LE,0,OR,R5,GE,1) GO TO 49
1133 IF(R5,GT,.9612) GO TO 32
1134 IF(R5,LT,.00957) GO TO 60
1135 SR3=AINTR(R5,FE,FSR3,27,FALSE)
1136 GO TO 33
1137 32 SR3=SQRT((1.5+SQRT(1.6*R5-1.75))/(2*(1-R5))
      )
1138 GO TO 33
1139 60 SR3=-SQRT((1+SQRT(1-18*R5))/(2*R5))
1140 33 F=SR3*R5/2+SQRT((SR3*R5/2)**2+2*R5)
1141 SR1=F**4/R3
1142 HR=R3/F
1143 B1=SQRT(-ALOG(RNDM(-1)))
1144 B2=2*PI*RNDM(-1)
1145 C4(1)=B1*COS(B2)+SR1
1146 C4(2)=B1*SIN(B2)
1147 IF(SR3,LT,3.25) GO TO 34
1148 R2=SR3-3.25
1149 R3=6.5
1150 GO TO 36
1151 34 R2=0
1152 IF(SR3,LT,0) GO TO 35
1153 R3=SR3-3.25
1154 GO TO 36
1155 35 R3=-0.1/2*SR3-2.7692*EXP(SR3))
1156 36 FM3=F*(SR3/2+SQRT(SR3**2/4+5),SR3)
1157 C4(3)=BJRD(F2,R2,R3,FM3,SR3)
1158 VM=RAST(FD,C4)*HR
1159 DO 37 I4=1,3
1160 37 V(I4)=C1(I4)*(C4(1)+C2(I4)+C4(2)+C3(I4)+C4(
      3))
1161 CALL NCOS(CO,V,V)
1162 RETURN
1163 38 IF(LKP,NE,1) K=MU(N)
1164 DO 42 J=1,10
1165 FEI(J)=FIE(J,V)
1166 42 FNI(J)=SIE(J,K)
1167 R2=AINTR(ST,AT,FEI,10,FALSE)
1168 VM=AINTR(ST,AT,FNI,10,FALSE)*VM
1169 C4(1)=ST*(R2*GR)
1170 C4(2)=0
1171 C4(3)=COS(R2*GR)
1172 DO 43 I5=1,3
1173 43 V(I5)=C1(I5)*C4(1)+C3(I5)*C4(3)
1174 RETURN
1175 49 PRINT 50
1176 50 FORMAT(1X, 'ЗАДАНИЕ ЗНАЧЕНИЯ КОЭФФИЦИЕНТОВ
      АККОМОДАЦИИ НЕ УДОВЛЕТ
1177 10Р90Т ФВЗИЧЕСКИМ УСЛОВИЯМ ОТРАЖЕНИЯ')

```

```

1178 STOP
1179 END
1180 SUBROUTINE WV(NS)
1181 COMMON/PES2/KPT(30),NT,N,N1,N2,PIP2(2),TEL
      (108)
1182 INTEGER PIP2
1183 PRINT 2,N2,PIP2(1),PIP2(2),(TEL(I),I=1,NS)
1184 2 FORMAT(/,'НОМЕР ТИПОВОЙ ПОРЯДОКЪ NT=',
      3,5X,'ПРИЗНАК P2=',I3/(9E14,5))
1185 *5X,'ПРИЗНАК P2=',I3/(9E14,5))
1186 RETURN
1187 END
1188 FUNCTION RAST(A,B)
1189 DIMENSION A(3),B(3)
1190 RAST=SQRT((B(1)-A(1))**2+(B(2)-A(2))**2+(B
      (3)-A(3))**2)
1191 RETURN
1192 END
1193 FUNCTION SCALAR(A,B)
1194 DIMENSION A(3),B(3)
1195 SCALAR=A(1)*B(1)+A(2)*B(2)+A(3)*B(3)
1196 RETURN
1197 END
1198 SUBROUTINE PERES(T1,T2,T3)
1199 COMMON/PES2/KPT(30),NT,N,N1,N2,PIP2(2),TEL
      (108)
1200 INTEGER PIP2
1201 DIMENSION T1(3),T2(3),T3(3)
1202 DO J (=1,3)
1203 T1(J)=TEL(J)
1204 T2(J)=TEL(J+3)
1205 1 T3(J)=TEL(J+6)
1206 RETURN
1207 END
1208 SUBROUTINE OPT(X,OPT,N)
1209 DIMENSION X(3),OPT(3)
1210 COMMON /BL2/A(3,3,50),A4(3,50),A44(50)/BLC
      /C(3),C1(3),C2(3),C3(3)
1211 * ,C4(3)
1212 DO I (=1,3)
1213 ORTN(I)=-AL(I,N)
1214 DO K (=1,3)
1215 1 ORTN(I)=ORTN(I)-A(I,K,N)*X(K)
1216 CALL NCOS(C0,ORTN,ORTN)
1217 RETURN
1218 END
1219 SUBROUTINE NORMAL(A,B,C,D)
1220 DIMENSION A(3),B(3),C(3),D(3)
1221 D(1)=(B(2)-A(2))*(C(3)-A(3))-(B(3)-A(3))*(
      C(2)-A(2))
1222 D(2)=(B(3)-A(3))*(C(1)-A(1))-(B(1)-A(1))*(
      C(3)-A(3))
1223 D(3)=(B(1)-A(1))*(C(2)-A(2))-(B(2)-A(2))*(
      C(1)-A(1))
1224 R=SQRT(D(1)**2+D(2)**2+D(3)**2)
1225 DO I (=1,3)
1226 1 D(I)=D(I)/R
1227 RETURN

```



```

1285      DO 1 K=1,3
1286      F1(I,K,N)=0
1287      A4(I,N)=A4(I,N)+AK(I,N)+B4(K)
1288      DO 1 J=1,3
1289      DO 1 M=1,3
1290      1 F1(I,K,N)=F1(I,K,N)+AK(J,I,N)+AK(M,K,N)+B1
           J,M)
1291      A44(N)=B44
1292      DO 3 I=1,3
1293      C=-2*A4(I,N)
1294      DO 2 K=1,3
1295      A4(I,N)=A4(I,N)-F1(I,K,N)*X0(K,N)
1296      2 C=C+F1(I,K,N)*X0(K,N)
1297      3 A44(N)=A44(N)+X0(I,N)*C
1298      RETURN
1299      END
1300      SUBROUTINE VECTOR(A,B,C)
1301      DIMENSION A(3),B(3),C(3)
1302      C(1)=A(2)*B(3)-A(3)*B(2)
1303      C(2)=A(3)*B(1)-A(1)*B(3)
1304      C(3)=A(1)*B(2)-A(2)*B(1)
1305      RETURN
1306      END
1307      SUBROUTINE PARAL(T1,T2,T3,N)
1308      COMMON /BL1/D(4,30),INP(50)/BL3/AK(3,3,50
           ),X0(3,50)
1309      1/BL4/C1(3),C2(3),C3(3),C4(3),B(3,3),B4(3),
           B44/B16/D5(3,3),AJM(3,3)
1310      DIMENSION X1(3),T2(3),T3(3)
1311      N=N+1
1312      CALL SYST(T1,T2,T3,N)
1313      CALL NCOS(T1,T3,C4)
1314      R1=SCALAR(C3,C4)
1315      IF (ABS(R1)-1.E-4) 1,2
1316      1 R1=0
1317      2 AJM(1,1)=SQRT(1-R1)
1318      AJM(2,1)=0
1319      AJM(3,1)=SQRT(R1)
1320      AJM(1,2)=-R1/SQRT(1+R1)
1321      AJM(2,2)=1/SQRT(1+R1)
1322      AJM(3,2)=SQRT(R1*(1-R1)/(1+R1))
1323      AJM(1,3)=-SQRT(R1/(1+R1))
1324      AJM(2,3)=AJM(1,3)
1325      AJM(3,3)=SQRT((1-R1)/(1+R1))
1326      DO 3 J=1,3
1327      DO 3 I=1,3
1328      C5(J,I)=0
1329      DO 3 M=1,3
1330      3 C5(J,I)=C5(J,I)+AJM(J,M)*AK(M,I,N)
1331      DO 4 J=1,3
1332      DO 4 I=1,3
1333      4 AK(J,I,N)=C5(J,I)
1334      B4(1)=-SQRT(R1/(1-R1))/2
1335      B4(2)=B4(1)
1336      B4(3)=.5
1337      CALL PERVX(R,B4,B44,N)
1338      Q(1,N)=0

```



```

1339      D(2,N)=RAST(T1,T2)*SQRT(1-R1)
1340      D(3,N)=0
1341      D(4,N)=RAST(T1,T3)*SQRT(1-R1)
1342      INFP(N)=1
1343      RETURN
1344      END
1345      SUBROUTINE TRAP(T1,T2,T3,S,N
1346      COMMON/BL1/D(4,50),INFP(50)/BL3/AK(3,3,50)
           ,X0(3,50)
1347      1/BL4/C1(3),C2(3),C3(3),C4(3),B(3,3),B4(3),
           B44
1348      DIMENSION T1(3),T2(3),T3(3),T4(3),C5(3,3),
           AJM(3,3)
1349      DATA AJM/-1.,3*0.,-0.7071,0.7071,0.2*0.707
           1/
1350      N=N+1
1351      CALL SYST(T1,T2,T3,N)
1352      CALL NCOS(T1,T3,C4)
1353      DO 1 J=1,3
1354      DO 1 I=1,3
1355      C5(J,I)=0
1356      DO 1 M=1,3
1357      1 C5(J,I)=C5(J,I)+AJM(J,M)*AK(M,I,N)
1358      DO 2 I=1,3
1359      C3(I)=C5(3,I)
1360      C2(I)=C5(2,I)
1361      DO 2 J=1,3
1362      2 AK(J,I,N)=C5(J,I)
1363      R1=RAST(T1,T2)*RAST(T1,T3)/(RAST(T1,T2)+S)
1364      R2=SCALAR(C3,C4)
1365      DO 3 I=1,3
1366      X0(I,N)=T1(I)+C4(I)*R1-C3(I)*R2*R1
1367      3 T4(I)=X0(I,N)
1368      B4(2)=0.35355
1369      B4(3)=B4(2)
1370      B44=-R1+R2*0.7071
1371      CALL PERYX(B,B4,B44,N)
1372      CALL NCOS(T4,T1,C1)
1373      D(1,N)=ATAN2(SQRT(1-(SCALAR(C2,C1)**2)),SC
           ALAR(C2,C1))
1374      CALL NCOS(T4,T2,C1)
1375      D(2,N)=ATAN2(SQRT(1-SCALAR(C2,C1)**2),SCAL
           AR(C2,C1))
1376      D(3,N)=0
1377      D(4,N)=RAST(T1,T3)*R2
1378      INFP(N)=2
1379      RETURN
1380      END
1381      SUBROUTINE KOLCO(T1,T2,T3,S,F3,F4,N)
1382      COMMON/BL1/D(4,50),INFP(50)/BL3/AK(3,3,50)
           ,X0(3,50)
1383      1/BL4/C1(3),C2(3),C3(3),C4(3),B(3,3),B4(3),
           B44/BL6/C5(3,3),AJM(3,3)
1384      DIMENSION T1(3),T2(3),T3(3),T7(3),T8(3)
1385      DATA PI/3.14159265/
1386      N=N+1
1387      CALL NCOS(T1,T2,C4)
1388      F1=F3

```

```

1389      F2=F4
1390      IF(RAST(T1,T2)-RAST(T1,T3))1,5,5
1391      1 R1=RAST(T1,T2)
1392      DO 2 I=1,3
1393      T7(I)=T3(I)
1394      2 T8(I)=T1(I)-R1*C4(I)
1395      S=S*RAST(T1,T7)/RAST(T1,T8)
1396      IF(F1-PI/2)3,4,4
1397      3 F1=3*PI/2+F1
1398      F2=3*PI/2+F2
1399      GO TO 13
1400      4 F1=F1-PI/2
1401      F2=F2-PI/2
1402      GO TO 13
1403      5 DO 12 I=1,3
1404      T7(I)=T2(I)
1405      12 T8(I)=T3(I)
1406      13 CALL SVST(T1,T7,T8,N)
1407      R1=RAST(T1,T8)/RAST(T1,T7)
1408      R2=SQRT(1-R1**2)
1409      AJM(1,1)=R1
1410      AJM(2,1)=0
1411      AJM(3,1)=-R2
1412      AJM(1,2)=0
1413      AJM(2,2)=1
1414      AJM(3,2)=0
1415      AJM(1,3)=R
1416      AJM(2,3)=0
1417      AJM(3,3)=R1
1418      DO 6 J=1,3
1419      DO 6 I=1,3
1420      C5(J,I)=0
1421      DO 6 M=1,3
1422      6 C5(J,I)=C5(J,I)+AJM(J,M)*AK(M,I,N)
1423      DO 7 J=1,3
1424      DO 7 I=1,3
1425      7 AK(J,I,N)=C5(J,I)
1426      B4(1)=R2/2
1427      B4(3)=R1/2
1428      CALL PERVX(B,B4,B44,N)
1429      D(1,N)=PI*ATAN2(-SIN(F1),-COS(F1)*R1)
1430      IF(F2-2*PI)8,9,10
1431      8 D(2,N)=PI*ATAN2(-SIN(F2),-COS(F2)*R1)
1432      GO TO 11
1433      9 D(2,N)=2*PI
1434      GO TO 11
1435      10 D(2,N)=3*PI+ATAN2(-SIN(F2),-COS(F2)*R1)
1436      11 D(3,N)=S*R1
1437      D(4,N)=RAST(T1,T8)
1438      IF(ABS(SIN(F1)).LT.,.1E-5) D(1,N)=F1
1439      IF(ABS(SIN(F2)).LT.,.1E-5) D(2,N)=F2
1440      INFP(N)=3
1441      RETURN
1442      END
1443      SUBROUTINE CIL(T1,T2,T3,H1,H2,F1,F2,N)
1444      COMMON /BL1/D(4,50),INFP(50)/BL4/C1(3),C2(
1445      3),C3(3),C4(3),B(3,3),

```

```

1446     DIMENSION T1(3),T2(3),T3(3)
1447     N=N+1
1448     CALL SYST(T1,T2,T3,N)
1449     B(1,1)=1/RAST(T1,T2)**2
1450     B(2,2)=1/RAST(T1,T3)**2
1451     B(3,3)=(H2/H1/RAST(T1,T2))**2
1452     B(1,3)=-B(1,1)*H2/H1
1453     B(3,1)=B(1,3)
1454     B44=-1
1455     CALL PERVX(B,B4,B44,N)
1456     D(1,N)=F1
1457     D(2,N)=F2
1458     D(3,N)=H2/H1
1459     D(4,N)=H1
1460     INFP(N)=2
1461     RETURN
1462     END
1463     SUBROUTINE ELIPS(T1,T2,T3,S,F1,F2,TETA1,TE
           TA2,N)
1464     COMMON /BL1/D(4,50),INFP(50)/BL4/C1(3),C2(
           3),C3(3),C4(3),B(3,3),
1465     1,B4(3),B44
1466     DIMENSION T1(3),T2(3),T3(3)
1467     N=N+1
1468     CALL SYST(T1,T2,T3,N)
1469     B(1,1)=1/RAST(T1,T2)**2
1470     B(2,2)=1/RAST(T1,T3)**2
1471     B(3,3)=1/S**2
1472     B44=-1
1473     CALL PERVX(B,B4,B44,N)
1474     D(1,N)=F1
1475     D(2,N)=F2
1476     D(3,N)=TETA1
1477     D(4,N)=TETA2
1478     INFP(N)=4
1479     RETURN
1480     END
1481     SUBROUTINE PARAB(T1,T2,T3,H1,H2,F1,F2,H3,M
           )
1482     COMMON /BL1/D(4,50),INFP(50)/BL4/C1(3),C2(
           3),C3(3),C4(3),B(3,3)
1483     1,B4(3),B44
1484     DIMENSION T1(3),T2(3),T3(3)
1485     N=N+1
1486     CALL SYST(T1,T2,T3,N)
1487     B(1,1)=1/RAST(T1,T2)**2
1488     B(2,2)=1/RAST(T1,T3)**2
1489     B(3,3)=B(1,1)*(H2/H1)**2
1490     B(1,3)=-B(1,1)*H2/H1
1491     B(3,1)=B(1,3)
1492     B4(3)=1/2./H1
1493     B44=-1
1494     CALL PERVX(B,B4,B44,N)
1495     D(1,N)=F1
1496     D(2,N)=F2
1497     D(3,N)=H2/H1
1498     D(4,N)=H3
1499     INFP(N)=2

```

```

1500 RETURN
1501 END
1502 SUBROUTINE CONUS(T1,T2,T3,H1,H2,P,F1,F2,N)
1503 COMMON /BL1/D(4,50),INFP(50)/BL4/C1(3),C2(
3),C3(3),C4(3),B(3,3),
1504 B4(3),B44
1505 DIMENSION T1(3),T2(3),T3(3)
1506 N=N+1
1507 CALL SUBST(T1,T2,T3,N)
1508 R2=H1*RAST(T1,T2)/(RAST(T1,T2)-P)
1509 R1=H2/H1*R2
1510 B(1,1)=1/RAST(T1,T2)**2
1511 B(2,2)=1/RAST(T1,T3)**2
1512 B(3,3)=(R1*R1*B(1,1)-1)/(R2*R2)
1513 B(1,3)=-F1*B(1,1)/R2
1514 B(3,1)=B(1,3)
1515 B4(3)=1/R2
1516 B44=-1
1517 CALL PERVX(B,B4,B44,1)
1518 D(1,N)=F1
1519 D(2,N)=F2
1520 D(3,N)=H2/H1
1521 D(4,N)=H1-0.0001
1522 INFP(N)=2
1523 RETURN
1524 END
1525 FUNCTION F2(V,S)
1526 IF(S,LT,-3.) GO TO 1
1527 F2=2/MI(S)*EXP(-(V-S)**2)*V
1528 GO TO 2
1529 1 F2=S**6*16*(EXP(2+S*V-V**2))*V/(S**6*6-6*
+5-15)
1530 2 RETURN
1531 END
1532 FUNCTION BIRD(F,A,B,C,S)
1533 DATA V/0/
1534 1 X=A+RNDM(-1)*B
1535 Y=Y+F(X,S)/C
1536 IF(V,LI,1.) GO TO 1
1537 Y=Y-1,
1538 BIRD=X
1539 RETURN
1540 END
1541 FUNCTION ERF(X)
1542 DIMENSION A(6)
1543 DATA(A=0,0705230784,0.0422820123,C,0092705
272,0.1520143E-3,
1544 10,2765672E-3,0.430638F-4)
1545 IF(ABS(X)-4,8) 1,3,3
1546 1 R=1,
1547 DO 2 I=1,6
1548 2 R=R+A(I)*ABS(X)**I
1549 ERF=SIGN(1-R**(-16),X)
1550 RETURN
1551 3 ERF=SIGN(1,,X)
1552 RETURN
1553 END
1554 FUNCTION MI(X)
1555 DATA(PI=3.14159265)

```

```

1556 IF (X,LT,-3,1) GO TO 1
1557 HI=EXP(-X**2)+SQRT(PI)*X*(1-ERF(X))
1558 GO TO 2
1559 1 HI=EXP(-X*X)*(X**4-6*X*X**15)/(X**6+8)
1560 2 RETURN
1561 END
1562 SUBROUTINE PR(TX,V,A,TV,N)
1563 DIMENSION TX(3),V0(3,50),A(3,3,50),TV(3)
1564 DO 1 I=1,3
1565 TV(I)=0
1566 DO 1 J=1,3
1567 1 TV(I)=TV(I)+A(I,J,N)*(TX(J)-V0(J,N))
1568 RETURN
1569 END
1570 FUNCTION AINTR (X,XT,VT,N,W)
1571 LOGICAL W
1572 DIMENSION XT(N),VT(N)
1573 IF (.NOT.W.AND.(X.GT.XT(N).OR.X.LT.XT(1)))IG
1574 K=1
1575 DO 1 I=2,N
1576 IF (X.GE.XT(I-1)) K=I-1
1577 1 CONTINUE
1578 AINTR=VT(K)+(X-XT(K))*(VT(K+1)-VT(K))/(XT(
1579 K+1)-XT(K))
1580 2 PRINT 3
1581 3 FORMAT(10X,'ЗНАЧЕНИЕ X ВЫХОДИТ ЗА ПРЕДЕЛЫ
1582 ОТРЕЗКА ИНТЕРПОЛЯЦИИ')
1583 RETURN
1584 END
1585 SUBROUTINE ST(N,X,V,T)
1586 COMMON/BL2/A(3,3,50),A4(3,50),A44(50)
1587 1/BL8/FPR(50),MD(50),MD1(50),MD2(50),KP ,KP
1588 DIMENSION X(3),V(3),T1(3),T2(3)
1589 T=1.E14
1590 AR=0
1591 BR=0
1592 CR=A44(N)
1593 DO 1 I=1,3
1594 BR=BR+A4(I,N)*V(I)
1595 CR=CR+A4(I,N)*X(I)
1596 DO 1 K=1,3
1597 AR=AR+A(I,K,N)*V(I)*V(K)
1598 BR=BR+A(I,K,N)*X(I)*V(K)
1599 1 CR=CR+A(I,K,N)*X(I)*X(K)
1600 BR=2*BR
1601 R=BR**2-4*AR*CR
1602 IF (R,LT,0.,OR,(AR,EQ,0.,AND,BR,EQ,0.)) GO
1603 TO 9
1603 IF (AR,EQ,0.) GO TO 2
1604 TM1=(-BR+SQRT(R))/2/AR
1605 TM2=(-BR-SQRT(R))/2/AR
1606 GO TO 3
1607 2 TM1=-CR/BR
1608 TM2=TM

```

```

1604 3 L1=0
1610 4 L2=0
1611 5 IF (T=1, L1=0, L2=0) GO TO 5
1612 6 DO 4 I=1,3
1613 7 T1=(Y(I)-V(I))/VT(I)*T
1614 8 AL=0.81071, L1, N1
1615 9 IF (T=2, L1=1, L2=0) GO TO 7
1616 10 DO 6 I=1,3
1617 11 T2=(Y(I)-V(I))/VT(I)*T
1618 12 CALL DBLDIT2, L2, N1
1619 13 IF (L1, EQ, 0, AND, L2, EQ, 0) GO TO 14
1620 14 IF (L1, EQ, 0, OR, L1, EQ, 1, AND, L2, EQ, 1, AND, T=
2, L1, T=1) GO TO 6
1621 15 T=TM1
1622 16 GO TO 6
1623 17 T=TM2
1624 18 IF (KPD, EQ, 0) GO TO 12
1625 19 IF (MD1, N1, EQ, 0) GO TO 12
1626 20 DO 10 I=1,3
1627 21 T(I)=Y(I)+V(I)*T
1628 22 L1=0
1629 23 I=MD1, N1
1630 24 J=MD2, N1
1631 25 DO 11 I=1,3
1632 26 CALL DBLDIT1, L1, I1
1633 27 IF (L1, EQ, 0) GO TO 11
1634 28 IF (KPR, EQ, 0) GO TO 13
1635 29 IF (FPR(I1), GE, .9999) GO TO 13
1636 30 IF (RNDM(I1) - F, FPR(I1)) GT 0 13
1637 31 GO TO 14
1638 32 CONTINUE
1639 33 IF (FPP(N), LE, .0001) GO TO 14
1640 34 IF (RNDM(I1) - F, FPP(N)) GT 0 14
1641 35 T=1, F14
1642 36 RETURN
1643 37 END
1644 38 SUBROUTINE DBLD(X, I, N)
1645 39 COMMON /BL1/D(4,50), INP(50)/BL3/AK(3,3,50
, X0(3,50)
1646 40 DIMENSION X(3), Y(3)
1647 41 DATA PI/3.14159265, PM/3.14159/
1648 42 CALL /RIX/X0, AK, I, N
1649 43 M=INP(I)
1650 44 L=0
1651 45 GO TO (1,2,15,6), M
1652 46 1) IF (Y(3), GE, -.0001) GO TO 2
1653 47 RETURN
1654 48 2) IF ((Y(1), LE, D(1,N), AND, Y(1), LE, D(2,N)), AND
, (Y(2), GE, D(3,N)), AND,
1655 49 1Y(2), LE, D(4,N)) L=1
1656 50 RETURN
1657 51 3) R1=PM+ATAN2(Y(2), -(Y(1)-Y(3)+D(5,N)))
1658 52 R2=Y(3)
1659 53 R3=0.
1660 54 IF (D(2,N)-2*PI, GT, 0.) GO TO 4
1661 55 IF ((R1, GE, D(1,N), AND, R1, LE, D(2,N)), AND, (R2
, GE, R3, AND, R2, LE, D(4,N))
1662 56 1) L=1

```



```

1663     RETURN
1664     4 IF(((R1.GE.D(1,N).AND.R1.LE.2*PI).AND.(R2.
      GE.R3.AND.R2.LE.D(4,N)))
1665     1.OR.(R1.E.0..AND.R1.LE.D(2,N)-2*PI).AND.
      (R2.GE.R3.AND.R2.LE.D(4,
1666     2N)))) L=1
1667     RETURN
1668     15 IF(Y(3).GE.-.00001) GO TO 5
1669     RETURN
1670     5 R1=PM+ATAN(-V(2),-V(1))
1671     R2=SQRT(V(1)**2+V(2)**2)
1672     R3=D(3,N)
1673     GO TO 3
1674     6 R1=PM+ATAN2(-V(2),-V(1))
1675     R2=ATAN2(SQRT(V(1)**2+V(2)**2),V(3))
1676     R3=D(3,N)
1677     GO TO 3
1678     END

```

## ПАРАМЕТРЫ ЗЕМЛИ

1. Параметры Земли, их обозначения и значения приведены в табл. 1.

Таблица 1

Параметр Земли	Обозначение	Значение параметра
Большая полуось общего земного эллипсоида, м	$a_0$	6378137
Сжатие общего земного эллипсоида	$\bar{\alpha}$	$0,3355891 \cdot 10^{-2}$
Произведение гравитационной постоянной на массу Земли, $\text{м}^3 \cdot \text{с}^{-2}$	$\mu$	$0,3986000 \cdot 10^{15}$
Константа потенциала нормального поля притяжения Земли, $\text{м}^2 \cdot \text{с}^{-2}$	$e$	$0,2633270 \cdot 10^{20}$
Угловая скорость вращения Земли, $\text{рад} \cdot \text{с}^{-1}$	$\omega_2$	$0,72921157 \cdot 10^{-4}$
Ускорение свободного падения, $\text{м} \cdot \text{с}^{-2}$	$g_0$	Определяют в точке взвешивания ИСЗ перед запуском или принимают равным 9,80665

2. Значения среднего радиуса Земли  $R_{\text{ср}}$  в зависимости от наклона орбиты ИСЗ, приведены в табл. 2 и на чертеже.

Таблица 2

Наклонение орбиты $i_0$ , град	Средний радиус Земли $R_{\text{ср}}$ , м	Наклонение орбиты $i_0$ , град	Средний радиус Земли $R_{\text{ср}}$ , м
0(180)	6378137	69(111)	6368809
23(157)	6376503	70(110)	6368687
35(145)	6374616	71(109)	6368569
48(132)	6372227	72(108)	6368457
50(130)	6371857	73(107)	6368350
51(129)	6371673	74(106)	6368248
52(128)	6371491	75(105)	6368152
53(127)	6371311	76(104)	6368061
54(126)	6371132	77(103)	6367976
55(125)	6370955	78(102)	6367897
56(124)	6370781	79(101)	6367824
57(123)	6370609	80(100)	6367758
58(122)	6370440	81(99)	6367697
59(121)	6370274	82(98)	6367642
60(120)	6370110	83(97)	6367594
62(118)	6369950	84(96)	6367552
63(117)	6369841	85(95)	6367516
65(115)	6369346	86(94)	6367487
66(114)	6369206	87(93)	6367464
67(113)	6369069	88(92)	6367449
68(112)	6368937	89(91)	6367435

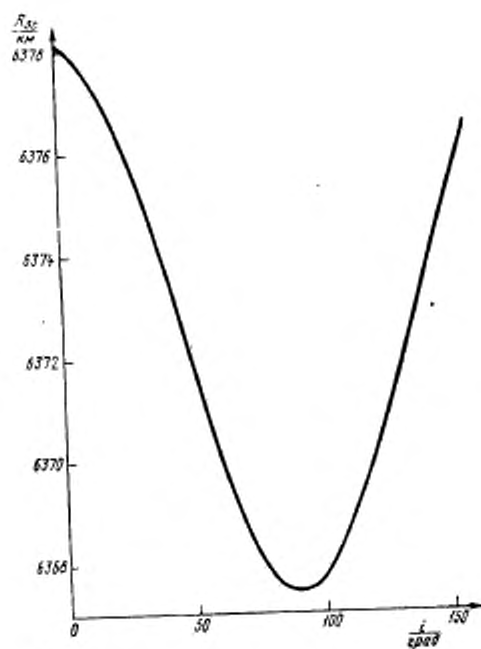

### ПРИМЕР РАСЧЕТА ЗАТРАТ ТОПЛИВА НА ПОДДЕРЖАНИЕ ВЫСОТЫ ОРБИТЫ ИСЗ В ЗАДАННОМ ДИАПАЗОНЕ ВЫСОТ

Расчет затрат топлива и характеристической скорости на циклические коррекции проведен по формулам (22)–(26) настоящего стандарта при следующих условиях:

для  $125 < h_{\max} < 300$  км  $\Delta h = 5$  км  
для  $300 < h_{\max} < 1500$  км  $\Delta h = 10$  км.

Расчет проведен для десяти фиксированных уровней солнечной активности:  $F_0 = 65; 75; 100; 125; 150; 175; 200; 225; 250; 275$  ( $\text{в } 10^{-22} \text{ Вт/м}^2 \cdot \text{Гц}$ ).

Результаты расчета в зависимости от высоты для конструктивных характеристик ИСЗ, приведенных в табл. 1, приведены в табл. 2–11.

Таблица 1

Конструктивная характеристика ИСЗ	Обозначение	Значение
Вес ИСЗ, кгс	$G_0$	10000
Эффективный удельный импульс, кгс·с/кгс	$J_{\text{эф}}$	300
Относительный вес непроизводительных затрат топлива при включении ДУ коррекции ИСЗ	$\bar{G}_{\text{тв}} = \frac{\Delta G_{\text{тв}}}{\Delta G_{\text{тн}}}$	$1 \cdot 10^{-2}$
Баллистический коэффициент ИСЗ, $\text{м}^3/\text{кгс} \cdot \text{с}^2$ Для $h < 400$ км Для $h \geq 400$ км	$S_k$	0,02 2,00

Параметры циклической коррекции для  $F_0 = 65 \times 10^{-22}$  Вт/м<sup>2</sup> Гц и номинальной плотности атмосферы

Высота, км	Время существования, сут	Количество полных циклов	Средняя длина шага		Средние затраты на шаг		Средние затраты за сутки	
			сут	ч	характеристическая скорость, м/с	длина, км	характеристическая скорость, м/с	длина, км
125	2.00+00	6.1+01	3.28-02	7.88-01	2.9211+00	9.9240+00	9.0424+01	3.0268+02
130	2.00+00	3.4+01	5.71-02	1.37+00	2.9581+00	1.0050+01	5.0696+01	1.7081+02
135	2.00+00	2.1+01	8.95-02	2.15+00	2.9743+00	1.0105+01	3.1381+01	1.0610+02
140	2.00+00	1.4+01	1.32-01	3.17+00	2.9815+00	1.0129+01	2.0934+01	7.0994+01
145	2.00+00	9.0+00	1.86-01	4.48+00	2.9857+00	1.0143+01	1.3459+01	4.5645+01
150	2.00+00	6.0+00	2.56-01	6.14+00	2.9858+00	1.0147+01	8.9695+00	3.0441+01
155	2.00+00	4.0+00	3.43-01	8.22+00	2.9834+00	1.0146+01	5.9758+00	2.0291+01
160	2.00+00	3.0+00	4.50-01	1.08+01	2.9844+00	1.0139+01	4.4778+00	1.5209+01
165	2.00+00	2.0+00	5.83-01	1.40+01	2.9835+00	1.0133+01	2.9825+00	1.0133+01
170	2.00+00	1.0+00	7.44-01	1.79+01	2.9804+00	1.0126+01	1.4898+00	5.0628+00
175	2.00+00	1.0+00	9.39-01	2.25+01	2.9770+00	1.0114+01	1.4881+00	3.0570+00
180	3.12+00	1.0+00	1.32+00	3.16+01	2.9736+00	1.0102+01	9.5123-01	3.3238+00
185	3.91+00	1.0+00	1.59+00	3.81+01	2.9702+00	1.0091+01	7.6009-01	2.5833+00
190	3.91+00	1.0+00	1.90+00	4.57+01	2.9668+00	1.0079+01	7.5922-01	2.5833+00
195	4.88+00	1.0+00	2.28+00	5.47+01	2.9634+00	1.0068+01	6.0687-01	2.0619+00
200	6.10+00	1.0+00	2.71+00	6.51+01	2.9601+00	1.0056+01	4.8477-01	1.6476+00
205	7.63+00	1.0+00	3.22+00	7.73+01	2.9567+00	1.0045+01	3.8737-01	1.3166+00
210	7.63+00	1.0+00	3.81+00	9.15+01	2.9533+00	1.0033+01	3.8693-01	1.3151+00
215	9.54+00	1.0+00	4.50+00	1.08+02	2.9500+00	1.0022+01	3.0919-01	1.0509+00
220	1.19+01	1.0+00	5.29+00	1.27+02	2.9466+00	1.0011+01	2.4707-01	8.2976-01
225	1.49+01	1.0+00	6.21+00	1.49+02	2.9433+00	9.9993+00	1.9743-01	6.7104-01
230	1.49+01	1.0+00	7.27+00	1.74+02	2.9399+00	9.9883+00	1.9720-01	6.7028-01
235	1.85+01	1.0+00	8.48+00	2.04+02	2.9366+00	9.9767+00	1.5758-01	5.3552-01
240	2.33+01	1.0+00	9.88+00	2.37+02	2.9333+00	9.9654+00	1.2592-01	4.2801-01
245	2.33+01	1.0+00	1.15+01	2.75+02	2.9299+00	9.9541+00	1.2578-01	4.2752-01
250	2.91+01	1.0+00	1.33+01	3.19+02	2.9266+00	9.9428+00	1.0051-01	3.4163-01
255	3.64+01	1.0+00	1.54+01	3.69+02	2.9233+00	9.9316+00	8.0317-02	2.7300-01
260	3.64+01	1.0+00	1.78+01	4.27+02	2.9200+00	9.9204+00	8.0226-02	2.7269-01
265	4.55+01	1.0+00	2.05+01	4.92+02	2.9167+00	9.9092+00	6.4108-02	2.1790-01
270	5.68+01	1.0+00	2.36+01	5.65+02	2.9134+00	9.8980+00	5.1229-02	1.7413-01
275	5.68+01	1.0+00	2.71+01	6.49+02	2.9101+00	9.8868+00	5.1171-02	1.7393-01
280	7.11+01	1.0+00	3.10+01	7.44+02	2.9069+00	9.8757+00	4.0891-02	1.3899-01
285	7.11+01	1.0+00	3.55+01	8.52+02	2.9036+00	9.8646+00	4.0894-02	1.3893-01
285	8.88+01	1.0+00	3.55+01	9.73+02	2.9003+00	9.8535+00	3.2639-02	1.1094-01
290	1.11+02	1.0+00	4.06+01	1.11+03	2.8971+00	9.8424+00	2.6082-02	8.8553-02
295	1.11+02	1.0+00	4.63+01	1.26+03	2.8938+00	9.8314+00	2.6052-02	8.8553-02
300	1.11+02	1.0+00	5.27+01					
310	1.39+02	1.0+00	6.81+01	1.63+03	2.8873+00	9.8093+00	2.0795-02	7.0684-02
320	2.17+02	1.0+00	8.75+01	2.10+03	2.8809+00	9.7874+00	1.3279-02	4.5136-02
330	2.71+02	1.0+00	1.12+02	2.69+03	2.8744+00	9.7655+00	1.0600-02	3.6028-02
340	3.39+02	1.0+00	1.42+02	3.42+03	2.8680+00	9.7437+00	8.4607-03	2.8758-02
350	4.24+02	1.0+00	1.81+02	4.33+03	2.8616+00	9.7220+00	6.7535-03	2.2955-02
360	5.29+02	1.0+00	2.28+02	5.47+03	2.8552+00	9.7004+00	5.3908-03	1.8323-02
370	6.62+02	1.0+00	2.86+02	6.87+03	2.8489+00	9.6788+00	4.3030-03	1.4626-02
370	8.27+02	1.0+00	2.86+02	8.60+03	2.8426+00	9.6573+00	3.4348-03	1.1675-02
380	1.03+03	1.0+00	3.58+02	1.07+04	2.8363+00	9.6359+00	2.7417-03	9.3193-03
390	1.03+03	1.0+00	4.47+02					
400	1.03+03	2.0+02	5.56+00	1.33+02	2.5722+00	8.7392+00	5.0482-01	1.7158+00
410	1.03+03	1.6+02	6.88+00	1.65+02	2.6178+00	8.8941+00	4.0746-01	1.3849+00
420	1.03+03	1.3+02	8.50+00	2.04+02	2.6531+00	9.0140+00	3.2831-01	1.1159+00
430	1.03+03	1.0+02	1.05+01	2.51+02	2.6801+00	9.1057+00	2.6428-01	8.9827-01
440	1.03+03	8.2+01	1.28+01	3.08+02	2.6998+00	9.1724+00	2.1402-01	7.2743-01
450	1.03+03	6.6+01	1.57+01	3.77+02	2.7144+00	9.2222+00	1.7319-01	5.8866-01
460	1.03+03	5.4+01	1.92+01	4.61+02	2.7240+00	9.2546+00	1.4220-01	4.8333-01
470	1.03+03	4.4+01	2.34+01	5.61+02	2.7310+00	9.2781+00	1.1616-01	3.9483-01
480	1.03+03	3.6+01	2.84+01	6.82+02	2.7354+00	9.2933+00	9.5195-02	3.2357-01
490	1.03+03	2.9+01	3.44+01	8.26+02	2.7385+00	9.3039+00	7.6771-02	2.6095-01
500	1.03+03	2.4+01	4.16+01	9.99+02	2.7390+00	9.3056+00	6.3517-02	2.1600-01
510	1.03+03	1.9+01	5.02+01	1.21+03	2.7395+00	9.3074+00	5.0317-02	1.7103-01
520	1.03+03	1.6+01	6.05+01	1.45+03	2.7374+00	9.3003+00	4.2340-02	1.4392-01
530	1.03+03	1.3+01	7.27+01	1.74+03	2.7353+00	9.2932+00	3.4375-02	1.1684-01
540	1.03+03	1.0+01	8.71+01	2.09+03	2.7333+00	9.2852+00	2.6422-02	8.9810-02

Вместа, км	Время существования, сут	Количество полных циклов	Средняя длина цикла		Средние затраты за цикл		Средние затраты за сутки	
			сут	ч	характеристическая скорость, м/с	топлива, кг	характеристическая скорость, м/с	топлива, кг
550	1.03+03	8.0+00	1.04+02	2.50+03	2.7299+00	9.2747+00	2.1112-02	7.1760-02
560	1.03+03	7.0+00	1.25+02	2.99+03	2.7253+00	9.2590+00	1.8442-02	6.2684-02
570	1.03+03	5.0+00	1.48+02	3.56+03	2.7219+00	9.2476+00	1.3156-02	4.4719-02
580	1.03+03	4.0+00	1.77+02	4.24+03	2.7173+00	9.2320+00	1.0507-02	3.5714-02
590	1.03+03	3.0+00	2.10+02	5.04+03	2.7127+00	9.2163+00	7.8570-03	2.6740-02
600	1.03+03	3.0+00	2.49+02	5.98+03	2.7069+00	9.1965+00	7.8501-03	2.6683-02
610	1.03+03	2.0+00	3.27+02	7.85+03	2.7022+00	9.1808+00	5.2245-03	1.7758-02
620	1.03+03	1.0+00	3.71+02	8.89+03	2.6975+00	9.1649+00	2.6077-03	8.8637-03
630	1.03+03	1.0+00	4.17+02	1.00+04	2.6918+00	9.1453+00	2.6021-03	8.8448-03
640	1.03+03	1.0+00	4.65+02	1.12+04	2.6860+00	9.1257+00	2.5996-03	8.8259-03
650	1.03+03	1.0+00	5.17+02	1.24+04	2.6803+00	9.1063+00	2.5910-03	8.8070-03
660	1.29+03	1.0+00	5.72+02	1.37+04	2.6746+00	9.0869+00	2.0684-03	7.0306-03
670	1.29+03	1.0+00	6.30+02	1.51+04	2.6689+00	9.0675+00	2.0640-03	7.0157-03
680	1.62+03	1.0+00	6.91+02	1.66+04	2.6632+00	9.0483+00	1.6477-03	5.6006-03
690	1.62+03	1.0+00	7.55+02	1.81+04	2.6576+00	9.0291+00	1.6442-03	5.5887-03
700	2.02+03	1.0+00	8.24+02	1.98+04	2.6519+00	9.0100+00	1.3126-03	4.4615-03
710	2.02+03	1.0+00	8.96+02	2.15+04	2.6463+00	8.9909+00	1.3098-03	4.4521-03
720	2.02+03	1.0+00	9.71+02	2.33+04	2.6407+00	8.9719+00	1.3070-03	4.4427-03
730	2.52+03	1.0+00	1.05+03	2.52+04	2.6351+00	8.9530+00	1.0434-03	3.5466-03
740	2.52+03	1.0+00	1.14+03	2.72+04	2.6296+00	8.9341+00	1.0412-03	3.5392-03
750	2.52+03	1.0+00	1.22+03	2.94+04	2.6241+00	8.9153+00	1.0390-03	3.5317-03
760	3.16+03	1.0+00	1.32+03	3.16+04	2.6185+00	8.8966+00	8.2948-04	2.8194-03
770	3.16+03	1.0+00	1.41+03	3.39+04	2.6130+00	8.8779+00	8.2774-04	2.8135-03
780	3.16+03	1.0+00	1.52+03	3.64+04	2.6076+00	8.8593+00	8.2601-04	2.8076-03
790	3.94+03	1.0+00	1.62+03	3.90+04	2.6021+00	8.8408+00	6.5943-04	2.2414-03
800	3.94+03	1.0+00	1.74+03	4.17+04	2.5967+00	8.8224+00	6.5805-04	2.2367-03
810	3.94+03	1.0+00	1.86+03	4.45+04	2.5913+00	8.8040+00	6.5668-04	2.2321-03
820	4.93+03	1.0+00	1.98+03	4.75+04	2.5859+00	8.7856+00	5.2425-04	1.7819-03
830	4.93+03	1.0+00	2.11+03	5.06+04	2.5805+00	8.7673+00	5.2316-04	1.7782-03
840	4.93+03	1.0+00	2.24+03	5.39+04	2.5751+00	8.7491+00	5.2207-04	1.7745-03
850	4.93+03	1.0+00	2.39+03	5.73+04	2.5698+00	8.7310+00	5.2099-04	1.7709-03
860	6.16+03	1.0+00	2.53+03	6.08+04	2.5644+00	8.7129+00	4.1593-04	1.4137-03
870	6.16+03	1.0+00	2.69+03	6.45+04	2.5591+00	8.6949+00	4.1507-04	1.4108-03
880	6.16+03	1.0+00	2.85+03	6.84+04	2.5538+00	8.6769+00	4.1421-04	1.4079-03
890	6.16+03	1.0+00	3.02+03	7.25+04	2.5486+00	8.6590+00	4.1335-04	1.4050-03
900	7.70+03	1.0+00	3.20+03	7.67+04	2.5433+00	8.6412+00	3.3000-04	1.1217-03
910	7.70+03	1.0+00	3.38+03	8.11+04	2.5381+00	8.6234+00	3.2932-04	1.1194-03
920	7.70+03	1.0+00	3.57+03	8.57+04	2.5329+00	8.6057+00	3.2864-04	1.1171-03
930	7.70+03	1.0+00	3.77+03	9.05+04	2.5277+00	8.5880+00	3.2797-04	1.1148-03
940	9.63+03	1.0+00	3.98+03	9.56+04	2.5225+00	8.5704+00	2.6181-04	8.9000-04
950	9.63+03	1.0+00	4.20+03	1.01+05	2.5173+00	8.5529+00	2.6130-04	8.8818-04
960	9.63+03	1.0+00	4.42+03	1.06+05	2.5122+00	8.5354+00	2.6077-04	8.8637-04
970	9.63+03	1.0+00	4.66+03	1.12+05	2.5071+00	8.5180+00	2.6024-04	8.8456-04
980	1.20+04	1.0+00	4.93+03	1.18+05	2.5019+00	8.5006+00	2.0776-04	7.0621-04
990	1.20+04	1.0+00	5.16+03	1.24+05	2.4969+00	8.4833+00	2.0735-04	7.0477-04
1000	1.20+04	1.0+00	5.42+03	1.30+05	2.4918+00	8.4661+00	2.0692-04	7.0334-04
1010	1.20+04	1.0+00	5.70+03	1.37+05	2.4867+00	8.4489+00	2.0650-04	7.0191-04
1020	1.20+04	1.0+00	5.99+03	1.44+05	2.4817+00	8.4318+00	2.0609-04	7.0049-04
1030	1.50+04	1.0+00	6.28+03	1.51+05	2.4767+00	8.4147+00	1.6454-04	5.5925-04
1040	1.50+04	1.0+00	6.59+03	1.58+05	2.4716+00	8.3977+00	1.6421-04	5.5812-04
1050	1.50+04	1.0+00	6.91+03	1.66+05	2.4667+00	8.3808+00	1.6387-04	5.5700-04
1060	1.50+04	1.0+00	7.24+03	1.74+05	2.4617+00	8.3639+00	1.6354-04	5.5588-04
1070	1.88+04	1.0+00	7.59+03	1.82+05	2.4567+00	8.3470+00	1.3057-04	4.4380-04
1080	1.88+04	1.0+00	7.95+03	1.91+05	2.4518+00	8.3303+00	1.3031-04	4.4291-04
1090	1.88+04	1.0+00	8.32+03	2.00+05	2.4469+00	8.3135+00	1.3004-04	4.4202-04
1100	1.88+04	1.0+00	8.70+03	2.09+05	2.4419+00	8.2969+00	1.2978-04	4.4114-04
1110	1.88+04	1.0+00	9.10+03	2.18+05	2.4371+00	8.2803+00	1.2953-04	4.4025-04
1120	2.35+04	1.0+00	9.52+03	2.28+05	2.4322+00	8.2637+00	1.0341-04	3.5150-04
1130	2.35+04	1.0+00	9.95+03	2.39+05	2.4273+00	8.2472+00	1.0321-04	3.5080-04
1140	2.35+04	1.0+00	1.04+04	2.49+05	2.4225+00	8.2307+00	1.0300-04	3.5010-04
1150	2.35+04	1.0+00	1.09+04	2.60+05	2.4177+00	8.2144+00	1.0279-04	3.4940-04
1160	2.35+04	1.0+00	1.13+04	2.72+05	2.4128+00	8.1980+00	1.0259-04	3.4870-04



Продолжение табл. 2

Высота, км	Время существования, сут	Количество полных циклов	Средняя длина цикла		Средние затраты за цикл		Средние затраты за сутки	
			сут	ч	характеристическая скорость, м/с	топлива, кг	характеристическая скорость, м/с	топлива, кг
1170	2.91+04	1.0+00	1.18+04	2.84+05	2.4080+00	8.1817+00	8.1911-05	2.7841-04
1180	2.94+04	1.0+00	1.23+04	2.95+05	2.4033+00	8.1655+00	8.1750-05	2.7786-04
1190	2.94+04	1.0+00	1.29+04	3.09+05	2.3985+00	8.1493+00	8.1558-05	2.7731-04
1200	2.94+04	1.0+00	1.34+04	3.22+05	2.3938+00	8.1332+00	8.1422-05	2.7676-04
1210	2.94+04	1.0+00	1.40+04	3.35+05	2.3890+00	8.1171+00	8.1262-05	2.7621-04
1220	2.94+04	1.0+00	1.46+04	3.49+05	2.3843+00	8.1011+00	8.1103-05	2.7567-04
1230	3.67+04	1.0+00	1.52+04	3.64+05	2.3796+00	8.0851+00	6.4754-05	2.2010-04
1240	3.67+04	1.0+00	1.58+04	3.79+05	2.3749+00	8.0692+00	6.4524-05	2.1967-04
1250	3.67+04	1.0+00	1.64+04	3.94+05	2.3703+00	8.0534+00	6.4498-05	2.1923-04
1260	3.67+04	1.0+00	1.71+04	4.10+05	2.3656+00	8.0376+00	6.4373-05	2.1880-04
1270	3.67+04	1.0+00	1.78+04	4.27+05	2.3610+00	8.0218+00	6.4250-05	2.1837-04
1280	4.59+04	1.0+00	1.85+04	4.44+05	2.3563+00	8.0061+00	5.1300-05	1.7435-04
1290	4.59+04	1.0+00	1.92+04	4.62+05	2.3517+00	7.9904+00	5.1199-05	1.7402-04
1300	4.59+04	1.0+00	2.00+04	4.80+05	2.3471+00	7.9748+00	5.1097-05	1.7368-04
1310	4.59+04	1.0+00	2.08+04	4.99+05	2.3425+00	7.9593+00	5.1001-05	1.7334-04
1320	4.59+04	1.0+00	2.16+04	5.18+05	2.3380+00	7.9438+00	5.0898-05	1.7300-04
1330	4.59+04	1.0+00	2.24+04	5.38+05	2.3334+00	7.9283+00	5.0796-05	1.7266-04
1340	5.74+04	1.0+00	2.33+04	5.59+05	2.3289+00	7.9129+00	4.0564-05	1.3786-04
1350	5.74+04	1.0+00	2.42+04	5.80+05	2.3244+00	7.8976+00	4.0478-05	1.3760-04
1360	5.74+04	1.0+00	2.51+04	6.02+05	2.3199+00	7.8823+00	4.0406-05	1.3733-04
1370	5.74+04	1.0+00	2.60+04	6.25+05	2.3154+00	7.8670+00	4.0330-05	1.3706-04
1380	5.74+04	1.0+00	2.70+04	6.48+05	2.3109+00	7.8518+00	4.0248-05	1.3680-04
1390	5.74+04	1.0+00	2.80+04	6.72+05	2.3064+00	7.8367+00	4.0168-05	1.3653-04
1400	7.17+04	1.0+00	2.91+04	6.97+05	2.3020+00	7.8216+00	3.2077-05	1.0902-04
1410	7.17+04	1.0+00	3.01+04	7.23+05	2.2976+00	7.8065+00	3.2012-05	1.0881-04
1420	7.17+04	1.0+00	3.12+04	7.49+05	2.2931+00	7.7915+00	3.1951-05	1.0860-04
1430	7.17+04	1.0+00	3.24+04	7.77+05	2.2887+00	7.7765+00	3.1889-05	1.0839-04
1440	7.17+04	1.0+00	3.35+04	8.05+05	2.2843+00	7.7616+00	3.1832-05	1.0818-04
1450	7.17+04	1.0+00	3.47+04	8.34+05	2.2800+00	7.7467+00	3.1769-05	1.0797-04
1460	8.97+04	1.0+00	3.60+04	8.63+05	2.2756+00	7.7319+00	2.5367-05	8.6214-05
1470	8.97+04	1.0+00	3.73+04	8.94+05	2.2713+00	7.7171+00	2.5319-05	8.6049-05
1480	8.97+04	1.0+00	3.85+04	9.26+05	2.2669+00	7.7024+00	2.5270-05	8.5885-05
1490	8.97+04	1.0+00	3.99+04	9.58+05	2.2626+00	7.6877+00	2.5223-05	8.5721-05
1500	8.97+04	1.0+00	4.13+04	9.92+05	2.2583+00	7.6731+00	2.5173-05	8.5558-05

Таблица 3

Параметры циклической коррекции для  $F_0=75 \cdot 10^{-22}$  Вт/м<sup>2</sup> Гц и номинальной плотности атмосферы

Высота, км	Время существования, сут	Количество полных циклов	Средняя длина цикла		Средние затраты за цикл		Средние затраты за сутки	
			сут	ч	характеристическая скорость, м/с	топлива, кг	характеристическая скорость, м/с	топлива, кг
125	2.00+00	6.1+01	3.28-02	7.86-01	2.9211+00	9.9240+00	9.0424+01	3.0268+02
130	2.00+00	3.4+01	5.67-02	1.36+00	2.9581+00	1.0050+01	5.0696+01	1.7084+02
135	2.00+00	2.1+01	8.84-02	2.12+00	2.9743+00	1.0105+01	3.1381+01	1.0510+02
140	2.00+00	1.4+01	1.29-01	3.11+00	2.9815+00	1.0129+01	2.0934+01	7.0904+01
145	2.00+00	1.0+01	1.82-01	4.37+00	2.9842+00	1.0138+01	1.4951+01	5.0691+01
150	2.00+00	7.0+00	2.48-01	5.96+00	2.9853+00	1.0142+01	1.0462+01	3.5497+01
155	2.00+00	5.0+00	3.31-01	7.94+00	2.9849+00	1.0141+01	7.4679+00	2.5352+01
160	2.00+00	3.0+00	4.33-01	1.04+01	2.9844+00	1.0139+01	4.4778+00	1.5209+01
165	2.00+00	2.0+00	5.57-01	1.34+01	2.9825+00	1.0133+01	2.9825+00	1.0133+01
170	2.00+00	1.0+00	7.08-01	1.70+01	2.9804+00	1.0126+01	1.4898+00	5.0628+00
175	2.00+00	1.0+00	8.89-01	2.13+01	2.9770+00	1.0114+01	1.4881+00	5.0570+00
180	2.50+00	1.0+00	1.21+00	2.90+01	2.9736+00	1.0102+01	1.1891+00	4.0410+00
185	3.12+00	1.0+00	1.46+00	3.50+01	2.9702+00	1.0091+01	9.5015-01	3.2291+00
190	3.91+00	1.0+00	1.75+00	4.21+01	2.9669+00	1.0079+01	7.5922-01	2.5803+00
195	4.88+00	1.0+00	2.10+00	5.03+01	2.9634+00	1.0068+01	6.0667-01	2.0619+00
200	6.10+00	1.0+00	2.49+00	5.99+01	2.9601+00	1.0056+01	4.8477-01	1.6476+00
205	6.10+00	1.0+00	2.96+00	7.10+01	2.9567+00	1.0045+01	4.8422-01	1.6458+00
210	7.63+00	1.0+00	3.49+00	8.39+01	2.9533+00	1.0033+01	3.8693-01	1.3151+00

Высота, км	Время существования, сут	Количество полных циклов	Средняя длина цикла		Средние затраты за цикл		Средние затраты за сутки	
			сут	"	характеристическая скорость, м/с	топлива, кг	характеристическая скорость, м/с	топлива, кг
215	9.54+00	1.0+00	4.11+00	9.87+01	2.9500+00	1.0322+01	3.0919-01	1.0509+00
220	1.19+01	1.0+00	4.83+00	1.16+02	2.9465+00	1.0311+01	2.4707-01	8.3976-01
225	1.19+01	1.0+00	5.65+00	1.35+02	2.9133+00	9.9993+00	2.4679-01	8.3880-01
230	1.49+01	1.0+00	6.58+00	1.58+02	2.9399+00	9.9880+00	1.9720-01	6.7028-01
235	1.86+01	1.0+00	7.66+00	1.84+02	2.9365+00	9.9767+00	1.5758-01	5.3562-01
240	1.85+01	1.0+00	8.89+00	2.15+02	2.9333+00	9.9654+00	1.5740-01	5.3501-01
245	2.33+01	1.0+00	1.03+01	2.47+02	2.9299+00	9.9541+00	1.2578-01	4.2752-01
250	2.91+01	1.0+00	1.19+01	2.85+02	2.9265+00	9.9428+00	1.0051-01	3.4163-01
255	2.91+01	1.0+00	1.37+01	3.28+02	2.9233+00	9.9316+00	1.0040-01	3.4125-01
260	3.64+01	1.0+00	1.57+01	3.77+02	2.9200+00	9.9204+00	8.0226-02	2.7269-01
265	3.64+01	1.0+00	1.89+01	4.32+02	2.9167+00	9.9092+00	8.0135-02	2.7238-01
270	4.55+01	1.0+00	2.06+01	4.95+02	2.9134+00	9.8980+00	6.4036-02	2.1766-01
275	5.68+01	1.0+00	2.35+01	5.65+02	2.9101+00	9.8868+00	5.1171-02	1.7393-01
280	5.68+01	1.0+00	2.68+01	6.44+02	2.9069+00	9.8757+00	5.1113-02	1.7374-01
285	7.11+01	1.0+00	3.05+01	7.33+02	2.9036+00	9.8546+00	4.0841-02	1.3883-01
290	7.11+01	1.0+00	3.47+01	8.33+02	2.9003+00	9.8535+00	4.0799-02	1.3868-01
295	8.88+01	1.0+00	3.94+01	9.45+02	2.8971+00	9.8424+00	3.2602-02	1.1082-01
300	1.11+02	1.0+00	4.46+01	1.07+03	2.8938+00	9.8314+00	2.6052-02	8.8553-02
310	1.39+02	1.0+00	5.70+01	1.37+03	2.8873+00	9.8093+00	2.0795-02	7.0684-02
320	1.73+02	1.0+00	7.24+01	1.74+03	2.8809+00	9.7874+00	1.6599-02	5.6420-02
330	2.17+02	1.0+00	9.15+01	2.20+03	2.8744+00	9.7655+00	1.3249-02	4.5035-02
340	2.71+02	1.0+00	1.15+02	2.76+03	2.8680+00	9.7437+00	1.0576-02	3.5948-02
350	3.39+02	1.0+00	1.44+02	3.46+03	2.8616+00	9.7220+00	8.4419-03	2.8694-02
360	4.24+02	1.0+00	1.80+02	4.31+03	2.8552+00	9.7004+00	6.7385-03	2.2904-02
370	5.29+02	1.0+00	2.23+02	5.35+03	2.8489+00	9.6788+00	5.3788-03	1.8283-02
380	6.62+02	1.0+00	2.76+02	6.62+03	2.8426+00	9.6573+00	4.2935-03	1.4594-02
390	8.27+02	1.0+00	3.40+02	8.15+03	2.8363+00	9.6359+00	3.4272-03	1.1649-02
400	8.27+02	2.2+02	4.17+00	1.00+02	2.5513+00	8.6785+00	6.7297-01	2.2872+00
410	8.27+02	1.8+02	5.10+00	1.22+02	2.6007+00	8.8361+00	5.5003-01	1.8694+00
420	8.27+02	1.4+02	6.23+00	1.49+02	2.6370+00	8.9593+00	4.4933-01	1.5272+00
430	8.27+02	1.1+02	7.57+00	1.82+02	2.6651+00	9.0546+00	3.6715-01	1.2479+00
440	8.27+02	9.3+01	9.18+00	2.20+02	2.6858+00	9.1251+00	3.0185-01	1.0259+00
450	8.27+02	7.6+01	1.11+01	2.66+02	2.7017+00	9.1789+00	2.4812-01	8.4334-01
460	8.27+02	6.2+01	1.34+01	3.21+02	2.7137+00	9.2199+00	2.0332-01	6.9105-01
470	8.27+02	5.1+01	1.61+01	3.87+02	2.7220+00	9.2479+00	1.6775-01	5.7018-01
480	8.27+02	4.2+01	1.93+01	4.64+02	2.7277+00	9.2672+00	1.3814-01	4.7054-01
490	8.27+02	3.5+01	2.31+01	5.55+02	2.7308+00	9.2777+00	1.1549-01	3.9256-01
500	8.27+02	2.9+01	2.76+01	6.63+02	2.7326+00	9.2839+00	9.5758-02	3.2548-01
510	8.27+02	2.4+01	3.29+01	7.91+02	2.7331+00	9.2856+00	7.9263-02	2.6941-01
520	8.27+02	2.0+01	3.92+01	9.41+02	2.7323+00	9.2830+00	6.6033-02	2.2445-01
530	8.27+02	1.6+01	4.65+01	1.12+03	2.7315+00	9.2803+00	5.2811-02	1.7951-01
540	8.27+02	1.4+01	5.51+01	1.32+03	2.7282+00	9.2689+00	4.0153-02	1.5588-01
550	8.27+02	1.1+01	6.52+01	1.53+03	2.7261+00	9.2619+00	3.6230-02	1.2317-01
560	8.27+02	9.0+00	7.69+01	1.85+03	2.7227+00	9.2505+00	2.9611-02	1.0065-01
570	8.27+02	8.0+00	9.05+01	2.18+03	2.7181+00	9.2349+00	2.6276-02	8.9314-02
580	8.27+02	6.0+00	1.07+02	2.56+03	2.7148+00	9.2235+00	1.9683-02	6.6903-02
590	8.27+02	5.0+00	1.25+02	3.03+03	2.7102+00	9.2079+00	1.6375-02	5.5658-02
600	8.27+02	4.0+00	1.47+02	3.52+03	2.7059+00	9.1924+00	1.3078-02	4.4451-02
610	8.27+02	3.0+00	1.91+02	4.59+03	2.7010+00	9.1768+00	9.7916-03	3.3282-02
620	8.27+02	2.0+00	2.29+02	5.50+03	2.6964+00	9.1612+00	6.5166-03	2.2150-02
630	8.27+02	2.0+00	2.69+02	6.45+03	2.6907+00	9.1416+00	9.5027-03	2.2103-02
640	8.27+02	1.0+00	3.10+02	7.14+03	2.6860+00	9.1257+00	3.2457-03	1.1032-02
650	8.27+02	1.0+00	3.53+02	8.47+03	2.6833+00	9.1063+00	3.2388-03	1.1009-02
660	8.27+02	1.0+00	3.98+02	9.56+03	2.6746+00	9.0859+00	3.2319-03	1.0085-02
670	1.03+03	1.0+00	4.46+02	1.07+04	2.6689+00	9.0675+00	2.5800-03	8.7696-03
680	1.03+03	1.0+00	4.90+02	1.19+04	2.6632+00	9.0483+00	2.5745-03	8.7510-03
690	1.29+03	1.0+00	5.49+02	1.32+04	2.6576+00	9.0291+00	2.0533-03	6.9859-03
700	1.29+03	1.0+00	6.05+02	1.45+04	2.6519+00	9.0100+00	2.0509-03	6.9711-03
710	1.62+03	1.0+00	6.63+02	1.59+04	2.6463+00	8.9909+00	1.6372-03	5.5651-03
720	1.62+03	1.0+00	7.25+02	1.74+04	2.6407+00	8.9719+00	1.6338-03	5.5533-03
730	1.62+03	1.0+00	7.90+02	1.90+04	2.6351+00	8.9530+00	1.6303-03	5.5416-03
740	2.02+03	1.0+00	8.58+02	2.07+04	2.6295+00	8.9341+00	1.3015-03	4.4240-03

Продолжение табл. 3

Высота, км	Время существования, сут	Количество полных циклов	Средняя длина цикла		Средние затраты за цикл		Средние затраты за сутки	
			сут	ч	характеристическая скорость, м/с	топлива, кг	характеристическая скорость, м/с	топлива, кг
750	2.02+03	1.0+00	9.30+02	2.23+04	2.6241+00	8.9153+00	1.2988-03	4.4147-03
760	2.02+03	1.0+00	1.01+03	2.41+01	2.6185+00	8.8966+00	1.2931-03	4.4054-03
770	2.52+03	1.0+00	1.08-03	2.60+04	2.6190+00	8.8779+00	1.0347-03	3.5169-03
780	2.52+03	1.0+00	1.17+03	2.80+04	2.6073+00	8.8593+00	1.0325-03	3.5095-03
790	2.52+03	1.0+00	1.25+03	3.01+04	2.6021+00	8.8408+00	1.0303-03	3.5022-03
800	3.16+03	1.0+00	1.34+03	3.23+04	2.5967+00	8.8224+00	8.2256-01	2.7959-03
810	3.16+03	1.0+00	1.44+03	3.45+04	2.5913+00	8.8040+00	8.2084-04	2.7901-03
820	3.16+03	1.0+00	1.54+03	3.69+04	2.5859+00	8.7856+00	8.1913-01	2.7843-03
830	3.94+03	1.0+00	1.64+03	3.94+04	2.5805+00	8.7673+00	6.5395-04	2.2228-03
840	3.94+03	1.0+00	1.75+03	4.20+04	2.5751+00	8.7491+00	6.5259-04	2.2182-03
850	3.94+03	1.0+00	1.87+03	4.48+04	2.5698+00	8.7310+00	6.5123-04	2.2136-03
860	4.93+03	1.0+00	1.98-03	4.76+04	2.5644+00	8.7129+00	5.1990-04	1.7672-03
870	4.93+03	1.0+00	2.11+03	5.06+04	2.5591+00	8.6949+00	5.1883-04	1.7635-03
880	4.93+03	1.0+00	2.24+03	5.37+04	2.5538+00	8.6769+00	5.1776-04	1.7599-03
890	4.93+03	1.0+00	2.37+03	5.69+04	2.5486+00	8.6590+00	5.1670-04	1.7563-03
900	6.16+03	1.0+00	2.51+03	6.03+04	2.5433+00	8.6412+00	4.1250-04	1.4021-03
910	6.16+03	1.0+00	2.66+03	6.38+04	2.5381+00	8.6234+00	4.1166-04	1.3992-03
920	6.16+03	1.0+00	2.81+03	6.75+04	2.5329+00	8.6057+00	4.1081-04	1.3964-03
930	6.16+03	1.0+00	2.97+03	7.13+04	2.5277+00	8.5880+00	4.0997-04	1.3935-03
940	7.70+03	1.0+00	3.14+03	7.53+04	2.5225+00	8.5704+00	3.2730-04	1.1125-03
950	7.70+03	1.0+00	3.31+03	7.94+04	2.5173+00	8.5529+00	3.2683-04	1.1102-03
960	7.70+03	1.0+00	3.49+03	8.37+04	2.5122+00	8.5354+00	3.2596-04	1.1080-03
970	7.70+03	1.0+00	3.67+03	8.82+04	2.5071+00	8.5180+00	3.2529-04	1.1057-03
980	9.63+03	1.0+00	3.87+03	9.28+04	2.5019+00	8.5006+00	2.5971-04	8.8276-04
990	9.63+03	1.0+00	4.07+03	9.76+04	2.4969+00	8.4833+00	2.5918-04	8.8096-04
1000	9.63+03	1.0+00	4.28+03	1.03+05	2.4918+00	8.4661+00	2.5865-04	8.7917-04
1010	9.63+03	1.0+00	4.49+03	1.08+05	2.4867+00	8.4489+00	2.5813-04	8.7739-04
1020	9.63+03	1.0+00	4.72+03	1.13+05	2.4817+00	8.4318+00	2.5761-04	8.7561-04
1030	1.20+04	1.0+00	4.95+03	1.19+05	2.4767+00	8.4147+00	2.0567-04	6.9907-04
1040	1.20+04	1.0+00	5.19+03	1.25+05	2.4716+00	8.3977+00	2.0525-04	6.9766-04
1050	1.20+04	1.0+00	5.44+03	1.31+05	2.4667+00	8.3808+00	2.0481-04	6.9625-04
1060	1.20+04	1.0+00	5.70+03	1.37+05	2.4617+00	8.3639+00	2.0443-04	6.9481-04
1070	1.20+04	1.0+00	5.97+03	1.43+05	2.4567+00	8.3470+00	2.0402-04	6.9345-04
1080	1.50+04	1.0+00	6.25+03	1.50+05	2.4518+00	8.3303+00	1.6288-04	5.5364-04
1090	1.50+04	1.0+00	6.54+03	1.57+05	2.4469+00	8.3135+00	1.6256-04	5.5253-04
1100	1.50+04	1.0+00	6.84+03	1.64+05	2.4419+00	8.2969+00	1.6223-04	5.5142-04
1110	1.50+04	1.0+00	7.15+03	1.72+05	2.4371+00	8.2803+00	1.6190-04	5.5032-04
1120	1.50+04	1.0+00	7.47+03	1.79+05	2.4322+00	8.2637+00	1.6158-04	5.4922-04
1130	1.88+04	1.0+00	7.80+03	1.87+05	2.4273+00	8.2472+00	1.2901-04	4.3850-04
1140	1.88+04	1.0+00	8.15+03	1.96+05	2.4225+00	8.2307+00	1.2875-04	4.3762-04
1150	1.88+04	1.0+00	8.50+03	2.04+05	2.4177+00	8.2144+00	1.2850-04	4.3675-04
1160	1.88+04	1.0+00	8.87+03	2.13+05	2.4128+00	8.1980+00	1.2824-04	4.3588-04
1170	1.88+04	1.0+00	9.25+03	2.22+05	2.4080+00	8.1817+00	1.2799-04	4.3502-04
1180	2.35+04	1.0+00	9.65+03	2.32+05	2.4033+00	8.1655+00	1.0218-04	3.4732-04
1190	2.35+04	1.0+00	1.01+04	2.41+05	2.3985+00	8.1493+00	1.0198-04	3.4663-04
1200	2.35+04	1.0+00	1.05+04	2.51+05	2.3938+00	8.1332+00	1.0178-04	3.4595-04
1210	2.35+04	1.0+00	1.09+04	2.62+05	2.3890+00	8.1171+00	1.0158-04	3.4526-04
1220	2.35+04	1.0+00	1.14+04	2.72+05	2.3843+00	8.1011+00	1.0138-04	3.4458-04
1230	2.94+04	1.0+00	1.18+04	2.84+05	2.3795+00	8.0851+00	8.0949-05	2.7512-04
1240	2.94+04	1.0+00	1.23+04	2.95+05	2.3749+00	8.0692+00	8.0785-05	2.7458-04
1250	2.94+04	1.0+00	1.28+04	3.07+05	2.3703+00	8.0534+00	8.0625-05	2.7404-04
1260	2.94+04	1.0+00	1.33+04	3.19+05	2.3656+00	8.0376+00	8.0465-05	2.7350-04
1270	2.94+04	1.0+00	1.38+04	3.32+05	2.3610+00	8.0218+00	8.0312-05	2.7297-04
1280	2.94+04	1.0+00	1.44+04	3.45+05	2.3563+00	8.0061+00	8.0154-05	2.7243-04
1290	3.67+04	1.0+00	1.49+04	3.58+05	2.3517+00	7.9904+00	6.3993-05	2.1752-04
1300	3.67+04	1.0+00	1.55+04	3.72+05	2.3471+00	7.9748+00	6.3870-05	2.1710-04
1310	3.67+04	1.0+00	1.61+04	3.86+05	2.3425+00	7.9593+00	6.3749-05	2.1667-04
1320	3.67+04	1.0+00	1.67+04	4.01+05	2.3380+00	7.9438+00	6.3618-05	2.1625-04
1330	3.67+04	1.0+00	1.73+04	4.16+05	2.3334+00	7.9283+00	6.3502-05	2.1583-04
1340	3.67+04	1.0+00	1.80+04	4.32+05	2.3289+00	7.9129+00	6.3373-05	2.1541-04
1350	4.59+04	1.0+00	1.87+04	4.48+05	2.3244+00	7.8976+00	5.0602-05	1.7199-04
1360	4.59+04	1.0+00	1.94+04	4.64+05	2.3199+00	7.8823+00	5.0507-05	1.7166-04

Высота, км	Время существования, сут	Количество полных циклов	Средняя длина цикла		Средние затраты за цикл		Средние затраты за сутки	
			сут	ч	характеристическая скорость, м/с	топлива, кг	характеристическая скорость, м/с	топлива, кг
1370	4.59+04	1.0+00	2.01+04	4.82+05	2.3154+00	7.8670+00	5.0405-05	1.7133-04
1380	4.59+04	1.0-00	2.08+04	4.99+05	2.3109+00	7.8518+00	5.0310-05	1.7100-04
1390	4.59+04	1.0+00	2.16+04	5.17+05	2.3064+00	7.8367+00	5.0214-05	1.7067-04
1400	4.59+04	1.0+00	2.23+04	5.36+05	2.3020+00	7.8216+00	5.0112-05	1.7034-04
1410	5.74+04	1.0+00	2.31+04	5.55+05	2.2976+00	7.8065+00	4.0021-05	1.3601-04
1420	5.74+04	1.0+00	2.40+04	5.75+05	2.2931+00	7.7915+00	3.9941-05	1.3575-04
1430	5.74+04	1.0+00	2.48+04	5.95+05	2.2887+00	7.7765+00	3.9860-05	1.3549-04
1440	5.74+04	1.0+00	2.57+04	6.16+05	2.2843+00	7.7616+00	3.9784-05	1.3523-04
1450	5.74+04	1.0+00	2.66+04	6.38+05	2.2800+00	7.7467+00	3.9708-05	1.3497-04
1460	5.74+04	1.0+00	2.75+04	6.60+05	2.2756+00	7.7319+00	3.9633-05	1.3471-04
1470	5.74+04	1.0+00	2.83+04	6.83+05	2.2713+00	7.7171+00	3.9559-05	1.3445-04
1480	7.17+04	1.0+00	2.94+04	7.06+05	2.2669+00	7.7024+00	3.1587-05	1.0736-04
1490	7.17+04	1.0+00	3.04+04	7.30+05	2.2626+00	7.6877+00	3.1525-05	1.0715-04
1500	7.17+05	1.0+00	3.15+04	7.55+05	2.2583+00	7.6731+00	3.1468-05	1.0695-04

Таблица 4

Параметры циклической коррекции для  $F_0=100 \cdot 10^{-22}$  Вт/м<sup>2</sup>·Гц и номинальной плотности атмосферы

Высота, км	Время существования, сут	Количество полных циклов	Средняя длина цикла		Средние затраты за цикл		Средние затраты за сутки	
			сут	ч	характеристическая скорость, м/с	топлива, кг	характеристическая скорость, м/с	топлива, кг
125	2.00+00	6.3+01	3.21-02	7.70-01	2.9181+00	9.9139+00	9.3341+01	3.1229+02
130	2.00+00	3.5+01	5.45-02	1.31+00	2.9551+00	1.0039+01	5.3650+01	1.8071+02
135	2.00+00	2.3+01	8.41-02	2.02+00	2.9713+00	1.0094+01	3.4352+01	1.1609+02
140	2.00+00	1.5+01	1.22-01	2.94+00	2.9800+00	1.0124+01	2.2424+01	7.5930+01
145	2.00+00	1.0+01	1.71-01	4.11+00	2.9842+00	1.0138+01	1.4951+01	5.0691+01
150	2.00+00	7.0+00	2.33-01	5.60+00	2.9853+00	1.0142+01	1.0462+01	3.5497+01
155	2.00+00	5.0+00	3.10-01	7.44+00	2.9849+00	1.0141+01	7.4679+00	2.5352+01
160	2.00+00	3.0+00	4.05-01	9.72+00	2.9844+00	1.0139+01	4.4778+00	1.5209+01
165	2.00+00	2.0+00	5.21-01	1.25+01	2.9825+00	1.0133+01	2.9825+00	1.0133+01
170	2.00+00	2.0+00	6.61-01	1.59+01	2.9791+00	1.0121+01	2.9791+00	1.0121+01
175	2.00+00	1.0+00	8.30-01	1.99+01	2.9770+00	1.0114+01	1.4881+00	5.0570+00
180	2.50+00	1.0+00	1.09+00	2.62+01	2.9735+00	1.0102+01	1.1891+00	4.0410+00
185	3.12+00	1.0+00	1.30+00	3.13+01	2.9702+00	1.0091+01	9.5015-01	3.2291+00
190	3.22+00	1.0+00	1.55+00	3.71+01	2.9668+00	1.0079+01	9.1903-01	3.2234+00
195	3.91+00	1.0+00	1.83+00	4.39+01	2.9634+00	1.0068+01	7.5836-01	2.5774+00
200	4.88+00	1.0+00	2.16+00	5.18+01	2.9601+00	1.0056+01	6.0598-01	2.0595+00
205	6.10+00	1.0+00	2.53+00	6.07+01	2.9567+00	1.0045+01	4.8422-01	1.6458+00
210	6.10+00	1.0+00	2.96+00	7.10+01	2.9533+00	1.0033+01	4.8367-01	1.6439+00
215	7.63+00	1.0+00	3.45+00	8.28+01	2.9500+00	1.0022+01	3.8649-01	1.3136+00
220	9.54+00	1.0+00	4.01+00	9.62+01	2.9466+00	1.0011+01	3.0884-01	1.0497+00
225	9.54+00	1.0+00	4.64+00	1.11+02	2.9433+00	9.9993+00	3.0849-01	1.0485+00
230	1.19+01	1.0+00	5.36+00	1.29+02	2.9399+00	9.9880+00	2.4651-01	8.3785+01
235	1.49+01	1.0+00	6.18+00	1.48+02	2.9366+00	9.9767+00	1.9398-01	6.6952+01
240	1.49+01	1.0+00	7.10+00	1.70+02	2.9333+00	9.9654+00	1.9676-01	6.6876+01
245	1.86+01	1.0+00	8.14+00	1.95+02	2.9299+00	9.9541+00	1.5723-01	5.3441-01
250	2.33+01	1.0+00	9.32+00	2.24+02	2.9266+00	9.9428+00	1.2504-01	4.2704-01
255	2.33+01	1.0+00	1.06+01	2.55+02	2.9233+00	9.9316+00	1.2550-01	4.2656-01
260	2.91+01	1.0+00	1.21+01	2.91+02	2.9200+00	9.9204+00	1.0028-01	3.4086-01
265	2.91+01	1.0+00	1.38+01	3.31+02	2.9167+00	9.9092+00	1.0017-01	3.4048-01
270	3.64+01	1.0+00	1.56+01	3.75+02	2.9134+00	9.8980+00	8.0045-02	2.7207-01
275	3.64+01	1.0+00	1.77+01	4.25+02	2.9101+00	9.8868+00	7.9955-02	2.7177-01
280	4.55+01	1.0+00	2.00+01	4.81+02	2.9069+00	9.8757+00	6.3892-02	2.1717-01
285	4.55+01	1.0+00	2.26+01	5.43+02	2.9036+00	9.8646+00	6.3820-02	2.1692-01
290	5.68+01	1.0+00	2.55+01	6.12+02	2.9003+00	9.8535+00	5.0998-02	1.7334-01
295	7.11+01	1.0+00	2.87+01	6.89+02	2.8971+00	9.8424+00	4.0753-02	1.3852-01
300	7.11+01	1.0+00	3.23+01	7.74+02	2.8938+00	9.8314+00	4.0707-02	1.3836-01
310	8.88+01	1.0+00	4.06+01	9.74+02	2.8873+00	9.8093+00	3.2493-02	1.1044-01
320	1.11+02	1.0+00	5.08+01	1.22+03	2.8809+00	9.7874+00	2.5936-02	8.8157-02
330	1.39+02	1.0+00	6.32+01	1.52+03	2.8744+00	9.7655+00	2.0702-02	7.0368-02



Высота, км	Время существования, сут	Количество полных циклов	Средняя длина цикла		Средние затраты за цикл		Средние затраты за сутки	
			сут	г	характеристическая скорость, м/с	топлива, кг	характеристическая скорость, м/с	топлива, кг
340	1,73+02	1,0+00	7,81+01	1,88+03	2,8580+00	9,7437+00	1,6525-02	5,6169-02
350	2,17+02	1,0+00	9,68+01	2,32+03	2,8616+00	9,7220+00	1,3190-02	4,4835-02
360	2,71+02	1,0+00	1,19+02	2,85+03	2,8552+00	9,7004+00	1,0529-02	3,5788-02
370	3,39+02	1,0+00	1,46+02	3,49+03	2,8489+00	9,6788+00	8,4044-03	2,8567-02
380	4,24+02	1,0+00	1,78+02	4,26+03	2,8429+00	9,6573+00	6,7088-03	2,2803-02
390	5,29+02	1,0+00	2,16+02	5,18+03	2,8363+00	9,6359+00	5,3550-03	1,8202-02
400	5,29+02	2,2+02	2,62+00	6,28+01	2,5484+00	8,6584+00	1,0732+00	3,6472+00
410	5,29+02	1,8+02	3,16+00	7,59+01	2,5935+00	8,8115+00	8,8645-01	3,0126+00
420	5,29+02	1,5+02	3,81+00	9,14+01	2,6284+00	8,9300+00	7,3456-01	2,4965+00
430	5,29+02	1,2+02	4,57+00	1,10+02	2,6563+00	9,0249+00	6,0692-01	2,0628+00
440	5,29+02	1,0+02	5,48+00	1,31+02	2,6770+00	9,0952+00	5,0549-01	1,7180+00
450	5,29+02	8,3+01	6,54+00	1,57+02	2,6928+00	9,1488+00	4,2202-01	1,4344+00
460	5,29+02	6,9+01	7,80+00	1,87+02	2,7048+00	9,1896+00	3,5240-01	1,1978+00
470	5,29+02	5,7+01	9,27+00	2,22+02	2,7143+00	9,2219+00	2,9213-01	9,9292-01
480	5,29+02	4,8+01	1,10+01	2,64+02	2,7200+00	9,2412+00	2,4652-01	8,3789-01
490	5,29+02	4,0+01	1,30+01	3,12+02	2,7244+00	9,2560+00	2,0576-01	6,9937-01
490	5,29+02	3,4+01	1,54+01	3,69+02	2,7262+00	9,2622+00	1,7501-01	5,9486-01
500	5,29+02	2,8+01	1,81+01	4,35+02	2,7280+00	9,2683+00	1,4422-01	4,9020-01
510	5,29+02	2,4+01	2,13+01	5,11+02	2,7272+00	9,2657+00	1,2358-01	4,2006-01
520	5,29+02	2,0+01	2,50+01	6,00+02	2,7264+00	9,2630+00	1,0296-01	3,4995-01
530	5,29+02	1,7+01	2,93+01	7,03+02	2,7244+00	9,2560+00	8,7446-02	2,9723-01
540	5,29+02	1,4+01	3,43+01	8,23+02	2,7223+00	9,2490+00	7,1960-02	2,4459-01
550	5,29+02	1,2+01	4,00+01	9,61+02	2,7190+00	9,2377+00	6,1604-02	2,0939-01
560	5,29+02	1,0+01	4,67+01	1,12+03	2,7156+00	9,2263+00	5,1274-02	1,7428-01
570	5,29+02	8,0+00	5,43+01	1,30+03	2,7123+00	9,2150+00	4,0969-02	1,3925-01
580	5,29+02	7,0+00	6,31+01	1,51+03	2,7077+00	9,1995+00	3,5787-02	1,2164-01
590	5,29+02	6,0+00	7,32+01	1,76+03	2,7032+00	9,1840+00	3,0623-02	1,0409-01
600	5,29+02	5,0+00	8,67+01	2,08+03	2,6986+00	9,1685+00	2,5476-02	8,6594-02
610	5,29+02	4,0+00	1,02+02	2,44+03	2,6941+00	9,1530+00	2,0346-02	6,9158-02
620	5,29+02	3,0+00	1,18+02	2,82+03	2,6895+00	9,1376+00	1,5234-02	5,1781-02
630	5,29+02	2,0+00	1,35+02	3,23+03	2,6849+00	9,1221+00	1,0139-02	3,4462-02
640	5,29+02	2,0+00	1,53+02	3,68+03	2,6792+00	9,1026+00	1,0117-02	3,4389-02
650	5,29+02	2,0+00	1,73+02	4,15+03	2,6735+00	9,0832+00	1,0096-02	3,4316-02
660	5,29+02	1,0+00	1,94+02	4,65+03	2,6689+00	9,0675+00	5,0391-03	1,7128-02
670	5,29+02	1,0+00	2,16+02	5,19+03	2,6632+00	9,0483+00	5,0284-03	1,7092-02
680	5,29+02	1,0+00	2,40+02	5,77+03	2,6576+00	9,0291+00	5,0177-03	1,7055-02
690	5,29+02	1,0+00	2,66+02	6,39+03	2,6519+00	9,0100+00	4,0057-03	1,3615-02
700	6,62+02	1,0+00	2,93+02	7,04+03	2,6463+00	8,9909+00	3,9972-03	1,3587-02
710	6,62+02	1,0+00	3,23+02	7,74+03	2,6407+00	8,9719+00	3,9888-03	1,3558-02
720	6,62+02	1,0+00	3,54+02	8,48+03	2,6351+00	8,9530+00	3,1843-03	1,0823-02
730	8,27+02	1,0+00	3,86+02	9,27+03	2,6296+00	8,9341+00	3,1776-03	1,0801-02
740	8,27+02	1,0+00	4,21+02	1,01+04	2,6241+00	8,9153+00	2,5367-03	8,6224-03
750	1,03+03	1,0+00	4,58+02	1,10+04	2,6185+00	8,8966+00	2,5314-03	8,6043-03
760	1,03+03	1,0+00	4,98+02	1,19+04	2,6130+00	8,8779+00	2,5261-03	8,5862-03
770	1,03+03	1,0+00	5,39+02	1,29+04	2,6076+00	8,8593+00	2,0166-03	6,8546-03
780	1,29+03	1,0+00	5,83+02	1,40+04	2,6021+00	8,8408+00	2,0124-03	6,8403-03
790	1,29+03	1,0+00	6,30+02	1,51+04	2,5967+00	8,8224+00	2,0082-03	6,8260-03
800	1,29+03	1,0+00	6,79+02	1,63+04	2,5913+00	8,8040+00	1,6032-03	5,4494-03
810	1,62+03	1,0+00	7,31+02	1,75+04	2,5859+00	8,7856+00	1,5999-03	5,4380-03
820	1,62+03	1,0+00	7,85+02	1,88+04	2,5805+00	8,7673+00	1,5965-03	5,4267-03
830	2,02+03	1,0+00	8,43+02	2,02+04	2,5751+00	8,7491+00	1,2746-03	4,3324-03
840	2,02+03	1,0+00	9,04+02	2,17+04	2,5698+00	8,7310+00	1,2719-03	4,3234-03
850	2,02+03	1,0+00	9,68+02	2,32+04	2,5644+00	8,7129+00	1,2693-03	4,3144-03
860	2,02+03	1,0+00	1,03+03	2,48+04	2,5591+00	8,6949+00	1,0133-03	3,4444-03
870	2,52+03	1,0+00	1,11+03	2,65+04	2,5538+00	8,6769+00	1,0112-03	3,4373-03
880	2,52+03	1,0+00	1,18+03	2,83+04	2,5486+00	8,6590+00	1,0092-03	3,4302-03
890	2,52+03	1,0+00	1,26+03	3,02+04	2,5433+00	8,6412+00	1,0071-03	3,4231-03
900	3,16+03	1,0+00	1,34+03	3,22+04	2,5381+00	8,6234+00	8,0401-04	2,7329-03
910	3,16+03	1,0+00	1,43+03	3,42+04	2,5329+00	8,6057+00	8,0235-04	2,7272-03
920	3,16+03	1,0+00	1,43+03	3,42+04	2,5329+00	8,6057+00	8,0235-04	2,7272-03

Высота, км	Время существования, сут	Количество полных циклов	Средняя длина цикла		Средние затраты за цикл		Средние затраты за сутки	
			сут	%	характеристическая скорость, м/с	топлива, кг	характеристическая скорость, м/с	топлива, кг
930	3.16+03	1.0+00	1.52+03	3.64+04	2.5277+00	8.5880+00	8.0071-04	2.7217-03
940	3.94+03	1.0+00	1.61-03	3.87+04	2.5225+00	8.5704+00	6.3925-04	2.1729-03
950	3.94+03	1.0+00	1.71+03	4.11+04	2.5173+00	8.5529+00	6.3795-04	2.1681-03
960	3.94+03	1.0+00	1.81+03	4.36+04	2.5122+00	8.5354+00	6.3664-04	2.1640-03
970	3.94+03	1.0+00	1.92+03	4.62+04	2.5071+00	8.5180+00	6.3535-04	2.1596-03
980	4.93+03	1.0+00	2.04+03	4.89+04	2.5019+00	8.5006+00	5.0725-04	1.7241-03
990	4.93+03	1.0+00	2.16+03	5.18+04	2.4969+00	8.4833+00	5.0621-04	1.7206-03
1000	4.93+03	1.0+00	2.28+03	5.48+04	2.4918+00	8.4661+00	5.0518-04	1.7171-03
1010	4.93+03	1.0+00	2.41+03	5.79+04	2.4867+00	8.4489+00	5.0416-04	1.7136-03
1020	6.16+03	1.0+00	2.55+03	6.12+04	2.4817+00	8.4318+00	4.0251-04	1.3681-03
1030	6.16+03	1.0+00	2.69+03	6.46+04	2.4767+00	8.4147+00	4.0169-04	1.3654-03
1040	6.16+03	1.0+00	2.84+03	6.81+04	2.4716+00	8.3977+00	4.0088-04	1.3626-03
1050	6.16+03	1.0+00	2.99+03	7.19+04	2.4667+00	8.3808+00	4.0008-04	1.3599-03
1060	7.70+03	1.0+00	3.16+03	7.58+04	2.4617+00	8.3639+00	3.1941-04	1.0857-03
1070	7.70+03	1.0+00	3.33+03	7.98+04	2.4567+00	8.3470+00	3.1876-04	1.0835-03
1080	7.70+03	1.0+00	3.50+03	8.40+04	2.4518+00	8.3303+00	3.1813-04	1.0813-03
1090	7.70+03	1.0+00	3.69+03	8.84+04	2.4469+00	8.3135+00	3.1749-04	1.0792-03
1100	9.63+03	1.0+00	3.88+03	9.30+04	2.4419+00	8.2969+00	2.5318-04	8.6160-04
1110	9.63+03	1.0+00	4.08+03	9.78+04	2.4371+00	8.2803+00	2.5298-04	8.5987-04
1120	9.63+03	1.0+00	4.28+03	1.03+05	2.4322+00	8.2637+00	2.5247-04	8.5815-04
1130	9.63+03	1.0+00	4.50+03	1.08+05	2.4273+00	8.2472+00	2.5197-04	8.5644-04
1140	9.63+03	1.0+00	4.73+03	1.13+05	2.4225+00	8.2307+00	2.5147-04	8.5473-04
1150	1.20+04	1.0+00	4.96+03	1.19+05	2.4177+00	8.2144+00	2.0077-04	6.8242-04
1160	1.20+04	1.0+00	5.20+03	1.25+05	2.4128+00	8.1980+00	2.0037-04	6.8106-04
1170	1.20+04	1.0+00	5.46+03	1.31+05	2.4080+00	8.1817+00	1.9997-04	6.7971-04
1180	1.20+04	1.0+00	5.72+03	1.37+05	2.4033+00	8.1655+00	1.9958-04	6.7836-04
1190	1.20+04	1.0+00	5.99+03	1.44+05	2.3985+00	8.1493+00	1.9918-04	6.7702-04
1200	1.50+04	1.0+00	6.28+03	1.51+05	2.3938+00	8.1332+00	1.5903-04	5.4054-04
1210	1.50+04	1.0+00	6.58+03	1.58+05	2.3890+00	8.1171+00	1.5871-04	5.3948-04
1220	1.50+04	1.0+00	6.88+03	1.65+05	2.3843+00	8.1011+00	1.5810-04	5.3841-04
1230	1.50+04	1.0+00	7.20+03	1.73+05	2.3796+00	8.0851+00	1.5809-04	5.3735-04
1240	1.88+04	1.0+00	7.53+03	1.81+05	2.3749+00	8.0693+00	1.2622-04	4.2903-04
1250	1.88+04	1.0+00	7.88+03	1.89+05	2.3703+00	8.0534+00	1.2597-04	4.2819-04
1260	1.88+04	1.0+00	8.24+03	1.98+05	2.3656+00	8.0376+00	1.2573-04	4.2735-04
1270	1.88+04	1.0+00	8.61+03	2.07+05	2.3610+00	8.0218+00	1.2548-04	4.2651-04
1280	1.88+04	1.0+00	8.99+03	2.16+05	2.3563+00	8.0061+00	1.2523-04	4.2568-04
1290	1.88+04	1.0+00	9.39+03	2.25+05	2.3517+00	7.9904+00	1.2499-04	4.2484-04
1300	2.35+04	1.0+00	9.80+03	2.35+05	2.3471+00	7.9748+00	9.9794-05	3.3921-04
1310	2.35+04	1.0+00	1.02+04	2.46+05	2.3425+00	7.9593+00	9.9601-05	3.3855-04
1320	2.35+04	1.0+00	1.07+04	2.56+05	2.3380+00	7.9438+00	9.9410-05	3.3789-04
1330	2.35+04	1.0+00	1.11+04	2.67+05	2.3334+00	7.9283+00	9.9219-05	3.3723-04
1340	2.35+04	1.0+00	1.16+04	2.79+05	2.3289+00	7.9129+00	9.9025-05	3.3658-04
1350	2.94+04	1.0+00	1.21+04	2.91+05	2.3244+00	7.8976+00	7.9062-05	2.6874-04
1360	2.94+04	1.0+00	1.26+04	3.03+05	2.3199+00	7.8823+00	7.8914-05	2.6822-04
1370	2.94+04	1.0+00	1.32+04	3.16+05	2.3154+00	7.8670+00	7.8764-05	2.6770-04
1380	2.94+04	1.0+00	1.37+04	3.29+05	2.3109+00	7.8518+00	7.8606-05	2.6718-04
1390	2.94+04	1.0+00	1.43+04	3.43+05	2.3064+00	7.8367+00	7.8454-05	2.6667-04
1400	3.67+04	1.0+00	1.49+04	3.57+05	2.3020+00	7.8216+00	6.2646-05	2.1292-04
1410	3.67+04	1.0+00	1.55+04	3.71+05	2.2976+00	7.8065+00	6.2528-05	2.1251-04
1420	3.67+04	1.0+00	1.61+04	3.86+05	2.2931+00	7.7915+00	6.2403-05	2.1210-04
1430	3.67+04	1.0+00	1.68+04	4.02+05	2.2887+00	7.7765+00	6.2282-05	2.1170-04
1440	3.67+04	1.0+00	1.74+04	4.18+05	2.2843+00	7.7616+00	6.2164-05	2.1129-04
1450	3.67+04	1.0+00	1.81+04	4.35+05	2.2800+00	7.7467+00	6.2045-05	2.1089-04
1460	4.59+04	1.0+00	1.88+04	4.52+05	2.2756+00	7.7319+00	4.9545-05	1.6839-04
1470	4.59+04	1.0+00	1.96+04	4.70+05	2.2713+00	7.7171+00	4.9449-05	1.6806-04
1480	4.59+04	1.0+00	2.04+04	4.89+05	2.2669+00	7.7024+00	4.9351-05	1.6774-04
1490	4.59+04	1.0+00	2.12+04	5.08+05	2.2626+00	7.6877+00	4.9255-05	1.6742-04
1500	4.59+04	1.0+00	2.20+04	5.28+05	2.2583+00	7.6731+00	4.9164-05	1.6711-04



Параметры циклической коррекции для  $F_0=125 \cdot 10^{-22}$  Вт/м<sup>2</sup>·Гц и номинальной  
 плотности атмосферы

Высота, км	Время существования, сут	Количество полных циклов	Среднее время цикла		Средние затраты за цикл		Средние затраты за сутки	
			сут	ч	характеристическая скорость, м/с	топлива, кг	характеристическая скорость, м/с	топлива, кг
125	2.00+00	6.2+01	3.25-02	7.79-01	2.9196-00	9.9190+00	9.1883+01	3.0749+02
130	2.00+00	3.6+01	5.49-02	1.32+00	2.9551+00	1.0039+01	5.3650+01	1.8071+02
135	2.00+00	2.3+01	8.33-02	2.00+00	2.9713+00	1.0094+01	3.4352+01	1.1609+02
140	2.00+00	1.5+01	1.19-01	2.85+00	2.9800+00	1.0124+01	2.2424+01	7.5930+01
145	2.00+00	1.1+01	1.64-01	3.93+00	2.9826+00	1.0133+01	1.6442+01	5.5732+01
150	2.00+00	8.0+00	2.18-01	5.24+00	2.9838+00	1.0137+01	1.1953+01	4.0547+01
155	2.00+00	6.0-00	2.85-01	6.84+00	2.9834+00	1.0136+01	8.9592+00	3.0407+01
160	2.00+00	4.0-00	3.65-01	8.77+00	2.9830+00	1.0134+01	5.9689+00	2.0268+01
165	2.00+00	3.0+00	4.62-01	1.11+01	2.9810+00	1.0128+01	4.4727+00	1.5191+01
170	2.00+00	2.0+00	5.76-01	1.38+01	2.9791+00	1.0121+01	2.9791+00	1.0121+01
175	2.00+00	1.0-00	7.12-01	1.71+01	2.9770+00	1.0114+01	1.4881+00	5.0570+00
180	2.00+00	1.0-00	9.05-01	2.17+01	2.9736+00	1.0102+01	1.4864+00	5.0512+00
185	2.50+00	1.0-00	1.07+00	2.57+01	2.9702+00	1.0091+01	1.1877+00	4.0363+00
190	3.12+00	1.0+00	1.26-00	3.02+01	2.9668+00	1.0079+01	9.4906-01	3.2254+00
195	3.12+00	1.0+00	1.48+00	3.54+01	2.9634+00	1.0068+01	9.4798-01	3.2217+00
200	3.91+00	1.0+00	1.72-00	4.14+01	2.9601+00	1.0056+01	7.5749-01	2.5744+00
205	4.88+00	1.0+00	2.01-00	4.81+01	2.9567+00	1.0045+01	6.0529-01	2.0572+00
210	4.88+00	1.0+00	2.33-00	5.58+01	2.9533+00	1.0033+01	6.0460-01	2.0549+00
215	6.10+00	1.0+00	2.69+00	6.45+01	2.9500+00	1.0022+01	4.8312-01	1.6420+00
220	7.63+00	1.0+00	3.10+00	7.43+01	2.9466+00	1.0011+01	3.8605-01	1.3121+00
225	7.63+00	1.0+00	3.56+00	8.54+01	2.9433+00	9.9993+00	3.8561-01	1.3106+00
230	9.54+00	1.0-00	4.08+00	9.79+01	2.9399+00	9.9883+00	3.0814-01	1.0473+00
235	9.54+00	1.0-00	4.67+00	1.12+02	2.9366+00	9.9767+00	3.0779-01	1.0461+00
240	1.19+01	1.0+00	5.32+00	1.28+02	2.9333+00	9.9654+00	2.4595-01	8.3595-01
245	1.49+01	1.0+00	6.06+00	1.45+02	2.9299+00	9.9511+00	1.9653-01	6.6801-01
250	1.49+01	1.0+00	6.88+00	1.65+02	2.9266+00	9.9428+00	1.9631-01	6.6725-01
255	1.86+01	1.0+00	7.79+00	1.87+02	2.9233+00	9.9316+00	1.5687-01	5.3320-01
260	1.83+01	1.0+00	8.82+00	2.12+02	2.9200+00	9.9204+00	1.5669-01	5.3260-01
265	2.33+01	1.0+00	9.96+00	2.39+02	2.9167+00	9.9092+00	1.2521-01	4.2560-01
270	2.33+01	1.0+00	1.12-01	2.69+02	2.9134+00	9.8980+00	1.2507-01	4.2512-01
275	2.91+01	1.0+00	1.26+01	3.03+02	2.9101+00	9.8868+00	9.9944-02	3.3971-01
280	2.91+01	1.0+00	1.42+01	3.40+02	2.9069+00	9.8757+00	9.9831-02	3.3933-01
285	3.64+01	1.0+00	1.59+01	3.82+02	2.9036+00	9.8646+00	7.9775-02	2.7116-01
290	3.64+01	1.0+00	1.78+01	4.28+02	2.9003+00	9.8535+00	7.9685-02	2.7085-01
295	4.55+01	1.0+00	1.99+01	4.78+02	2.8971+00	9.8424+00	6.3676-02	2.1644-01
300	4.55+01	1.0+00	2.22+01	5.34+02	2.8938+00	9.8314+00	6.3605-02	2.1619-01
310	5.68+01	1.0-00	2.76+01	6.63+02	2.8873+00	9.8093+00	5.0770-02	1.7257-01
320	7.11+01	1.0+00	3.42+01	8.20+02	2.8809+00	9.7874+00	4.0525-02	1.3775-01
330	8.88+01	1.0+00	4.20+01	1.01+03	2.8744+00	9.7655+00	3.2347-02	1.0995-01
340	1.11+02	1.0+00	5.15+01	1.24+03	2.8580+00	9.7437+00	2.5820-02	8.7764-02
350	1.39+02	1.0+00	6.28+01	1.51+03	2.8516+00	9.7220+00	2.0610-02	7.0054-02
360	1.73+02	1.0+00	7.63+01	1.83+03	2.8552+00	9.7004+00	1.6451-02	5.5919-02
370	2.17+02	1.0+00	9.24+01	2.22+03	2.8489+00	9.6788+00	1.3132-02	4.4636-02
380	2.71+02	1.0+00	1.11+02	2.68+03	2.8426+00	9.6573+00	1.0482-02	3.5629-02
390	2.71+02	1.0+00	1.34+02	3.22+03	2.8363+00	9.6359+00	1.0459-02	3.5550-02
400	2.71+02	1.8-02	1.61+00	3.86+01	2.8295+00	8.8252+00	1.7439+00	5.9258+00
410	2.71+02	1.5-02	1.92+00	4.61+01	2.8313+00	8.9400+00	1.4559+00	4.9474+00
420	2.71+02	1.2+02	2.29+00	5.50+01	2.8581+00	9.0310+00	1.2157+00	4.1315+00
430	2.71+02	1.0+02	2.72+00	6.54+01	2.8789+00	9.1015+00	1.0177+00	3.4583+00
440	2.71+02	8.6+01	3.23+00	7.75+01	2.6947+00	9.1552+00	8.5471-01	2.9048+00
450	2.71+02	7.2+01	3.82+00	9.17+01	2.7068+00	9.1962+00	7.1876-01	2.4428+00
460	2.71+02	6.0+01	4.51+00	1.08+02	2.7163+00	9.2286+00	6.0106-01	2.0428+00
470	2.71+02	5.1+01	5.31+00	1.27+02	2.7220+00	9.2479+00	5.1197-01	1.7401+00
480	2.71+02	4.3+01	6.24+00	1.50+02	2.7264+00	9.2629+00	4.3235-01	1.4695+00
490	2.71+02	3.6+01	7.31+00	1.76+02	2.7295+00	9.2734+00	3.6238-01	1.2317+00
500	2.71+02	3.1+01	8.56+00	2.05+02	2.7300+00	9.2752+00	3.1210-01	1.0608+00
510	2.71+02	2.6+01	9.99+00	2.40+02	2.7305+00	9.2769+00	2.6181-01	8.8987-01
520	2.71+02	2.2+01	1.16+01	2.83+02	2.7298+00	9.2743+00	2.2147-01	7.5275-01
530	2.71+02	1.9+01	1.36+01	3.25+02	2.7277+00	9.2673+00	1.9112-01	6.4962-01
540	2.71+02	1.6+01	1.57+01	3.78+02	2.7256+00	9.2603+00	1.6082-01	5.4663-01

Высота, км	Время существования, сут	Количество полных циклов	Средняя длина цикла		Средние затраты за цикл		Средние затраты за сутки	
			сут	ч	характеристическая скорость, м/с	топлива, кг	характеристическая скорость, м/с	топлива, кг
550	2.71+02	1.3+01	1.83+01	4.38+02	2.7236+00	9.2533+00	1.3057-01	4.4383-01
560	2.71+02	1.1+01	2.11+01	5.07+02	2.7202+00	9.2419+00	1.1035-01	3.7506-01
570	2.71+02	1.0+01	2.44+01	5.86+02	2.7156+00	9.2263+00	1.0014-01	3.4039-01
580	2.71+02	8.0+00	2.82+01	6.77+02	2.7123+00	9.2150+00	8.0017-02	2.7198-01
590	2.71+02	7.0+00	3.25+01	7.80+02	2.7077+00	9.1995+00	6.9897-02	2.3758-01
600	2.71+02	6.0+00	3.74+01	8.98+02	2.7032+00	9.1840+00	5.9811-02	2.0330-01
610	2.71+02	5.0+00	4.24+01	1.02+03	2.6986+00	9.1685+00	4.9758-02	1.6913-01
620	2.71+02	4.0+00	4.83+01	1.16+03	2.6941+00	9.1530+00	3.9739-02	1.3507-01
630	2.71+02	3.0+00	5.47+01	1.31+03	2.6895+00	9.1376+00	2.9754-02	1.0114-01
640	2.71+02	3.0+00	6.17+01	1.48+03	2.6838+00	9.1181+00	2.9691-02	1.0092-01
650	2.71+02	2.0+00	6.94+01	1.66+03	2.6792+00	9.1026+00	1.9760-02	6.7165-02
660	2.71+02	2.0+00	7.77+01	1.86+03	2.6735+00	9.0832+00	1.9718-02	6.7022-02
670	2.71+02	2.0+00	8.67+01	2.08+03	2.6678+00	9.0639+00	1.9676-02	6.6883-02
680	2.71+02	1.0+00	9.65+01	2.32+03	2.6632+00	9.0483+00	9.8211-03	3.3382-02
690	2.71+02	1.0+00	1.07+02	2.57+03	2.6576+00	9.0291+00	9.8002-03	3.3311-02
700	2.71+02	1.0+00	1.19+02	2.84+03	2.6519+00	9.0100+00	9.7795-03	3.3241-02
710	2.71+02	1.0+00	1.31+02	3.14+03	2.6463+00	8.9909+00	9.7588-03	3.3171-02
720	3.39+02	1.0+00	1.44+02	3.46+03	2.6407+00	8.9719+00	7.7905-03	2.6480-02
730	3.39+02	1.0+00	1.59+02	3.81+03	2.6351+00	8.9530+00	7.7741-03	2.6425-02
740	4.24+02	1.0+00	1.74+02	4.18+03	2.6296+00	8.9341+00	6.2062-03	2.1095-02
750	4.24+02	1.0+00	1.91+02	4.58+03	2.6241+00	8.9153+00	6.1931-03	2.1051-02
760	4.24+02	1.0+00	2.08+02	5.00+03	2.6185+00	8.8966+00	6.1801-03	2.1007-02
770	5.29+02	1.0+00	2.28+02	5.46+03	2.6130+00	8.8779+00	4.9337-03	1.6770-02
780	5.29+02	1.0+00	2.48+02	5.95+03	2.6076+00	8.8593+00	4.9234-03	1.6735-02
790	6.62+02	1.0+00	2.70+02	6.48+03	2.6021+00	8.8408+00	3.9305-03	1.3360-02
800	6.62+02	1.0+00	2.94+02	7.05+03	2.5967+00	8.8224+00	3.9223-03	1.3332-02
810	6.62+02	1.0+00	3.19+02	7.65+03	2.5913+00	8.8040+00	3.9141-03	1.3304-02
820	8.27+02	1.0+00	3.45+02	8.29+03	2.5859+00	8.7856+00	3.1247-03	1.0621-02
830	8.27+02	1.0+00	3.74+02	8.98+03	2.5805+00	8.7673+00	3.1182-03	1.0599-02
840	8.27+02	1.0+00	4.05+02	9.71+03	2.5751+00	8.7491+00	3.1118-03	1.0577-02
850	1.03+03	1.0+00	4.37+02	1.05+04	2.5698+00	8.7310+00	2.4842-03	8.4441-03
860	1.03+03	1.0+00	4.72+02	1.13+04	2.5644+00	8.7129+00	2.4791-03	8.4266-03
870	1.03+03	1.0+00	5.09+02	1.22+04	2.5591+00	8.6949+00	2.4740-03	8.4092-03
880	1.29+03	1.0+00	5.48+02	1.31+04	2.5538+00	8.6769+00	1.9751-03	6.7134-03
890	1.29+03	1.0+00	5.89+02	1.41+04	2.5483+00	8.6590+00	1.9710-03	6.6996-03
900	1.29+03	1.0+00	6.34+02	1.52+04	2.5433+00	8.6412+00	1.9670-03	6.6858-03
910	1.62+03	1.0+00	6.80+02	1.63+04	2.5381+00	8.6234+00	1.5703-03	5.3376-03
920	1.62+03	1.0+00	7.30+02	1.75+04	2.5329+00	8.6057+00	1.5671-03	5.3267-03
930	1.62+03	1.0+00	7.83+02	1.88+04	2.5277+00	8.5880+00	1.5639-03	5.3157-03
940	2.02+03	1.0+00	8.39+02	2.01+04	2.5225+00	8.5704+00	1.2485-03	4.2439-03
950	2.02+03	1.0+00	8.98+02	2.16+04	2.5173+00	8.5529+00	1.2460-03	4.2352-03
960	2.02+03	1.0+00	9.61+02	2.31+04	2.5122+00	8.5354+00	1.2434-03	4.2265-03
970	2.52+03	1.0+00	1.03+03	2.47+04	2.5071+00	8.5180+00	9.9273-04	3.3743-03
980	2.52+03	1.0+00	1.10+03	2.63+04	2.5019+00	8.5006+00	9.9071-04	3.3675-03
990	2.52+03	1.0+00	1.17+03	2.81+04	2.4969+00	8.4833+00	9.8869-04	3.3606-03
1000	2.52+03	1.0+00	1.25+03	3.00+04	2.4918+00	8.4661+00	9.8668-04	3.3538-03
1010	3.16+03	1.0+00	1.33+03	3.20+04	2.4867+00	8.4489+00	7.8774-04	2.6776-03
1020	3.16+03	1.0+00	1.42+03	3.41+04	2.4817+00	8.4318+00	7.8615-04	2.6721-03
1030	3.16+03	1.0+00	1.51+03	3.63+04	2.4767+00	8.4147+00	7.8456-04	2.6667-03
1040	3.94+03	1.0+00	1.61+03	3.86+04	2.4716+00	8.3977+00	6.2638-04	2.1291-03
1050	3.94+03	1.0+00	1.71+03	4.11+04	2.4667+00	8.3808+00	6.2511-04	2.1248-03
1060	3.94+03	1.0+00	1.82+03	4.37+04	2.4617+00	8.3639+00	6.2385-04	2.1205-03
1070	3.94+03	1.0+00	1.93+03	4.64+04	2.4567+00	8.3470+00	6.2260-04	2.1162-03
1080	4.93+03	1.0+00	2.05+03	4.93+04	2.4518+00	8.3303+00	4.9708-04	1.6896-03
1090	4.93+03	1.0+00	2.18+03	5.23+04	2.4469+00	8.3135+00	4.9608-04	1.6862-03
1100	4.93+03	1.0+00	2.31+03	5.55+04	2.4419+00	8.2969+00	4.9508-04	1.6828-03
1110	4.93+03	1.0+00	2.45+03	5.89+04	2.4371+00	8.2803+00	4.9409-04	1.6794-03
1120	6.16+03	1.0+00	2.60+03	6.24+04	2.4322+00	8.2637+00	3.9448-04	1.3409-03
1130	6.16+03	1.0+00	2.76+03	6.61+04	2.4273+00	8.2472+00	3.9370-04	1.3382-03
1140	6.16+03	1.0+00	2.92+03	7.00+04	2.4225+00	8.2307+00	3.9291-04	1.3355-03
1150	7.70+03	1.0+00	3.09+03	7.41+04	2.4177+00	8.2144+00	3.1370-04	1.0663-03
1160	7.70+03	1.0+00	3.27+03	7.84+04	2.4128+00	8.1980+00	3.1308-04	1.0642-03
1170	7.70+03	1.0+00	3.46+03	8.29+04	2.4080+00	8.1817+00	3.1246-04	1.0620-03
1180	7.70+03	1.0+00	3.65+03	8.77+04	2.4033+00	8.1655+00	3.1184-04	1.0599-03

Продолжение табл. 5

Высота, км	Время существования, сут	Количество полных циклов	Средняя длина цикла		Средние затраты за цикл		Средние затраты за сутки	
			сут	ч	характеристическая скорость, м/с	топлива, кг	характеристическая скорость, м/с	топлива, кг
1190	9.63+03	1.0+00	3.86+03	9.27-04	2.3985+00	8.1493+00	2.4897-04	8.4627-04
1200	9.63+03	1.0+00	4.08+03	9.79+04	2.3938+00	8.1332+00	2.4848-04	8.4460-04
1210	9.63+03	1.0+00	4.31+03	1.03+05	2.3890+00	8.1171+00	2.4799-04	8.4293-04
1220	9.63+03	1.0+00	4.55+03	1.09+05	2.3843+00	8.1011+00	2.4750-04	8.4127-04
1230	9.63+03	1.0+00	4.80+03	1.15+05	2.3796+00	8.0851+00	2.4702-04	8.3961-04
1240	1.20+04	1.0+00	5.06+03	1.21+05	2.3749+00	8.0692+00	1.9722-04	6.7037-04
1250	1.20+04	1.0+00	5.33+03	1.28+05	2.3703+00	8.0534+00	1.9684-04	6.6905-04
1260	1.20+04	1.0+00	5.62+03	1.35+05	2.3656+00	8.0376+00	1.9645-04	6.6773-04
1270	1.20+04	1.0+00	5.92+03	1.42+05	2.3610+00	8.0218+00	1.9607-04	6.6643-04
1280	1.50+04	1.0+00	6.24+03	1.50+05	2.3563+00	8.0061+00	1.9564-04	6.6510-04
1290	1.50+04	1.0+00	6.57+03	1.58+05	2.3517+00	7.9904+00	1.9524-04	6.6376-04
1300	1.50+04	1.0+00	6.91+03	1.66+05	2.3471+00	7.9748+00	1.9593-04	6.6242-04
1310	1.50+04	1.0+00	7.27+03	1.75+05	2.3425+00	7.9593+00	1.9563-04	6.6108-04
1320	1.88+04	1.0+00	7.65+03	1.84+05	2.3380+00	7.9438+00	1.9426-04	6.5974-04
1330	1.88+04	1.0+00	8.05+03	1.93+05	2.3334+00	7.9283+00	1.9402-04	6.5840-04
1340	1.88+04	1.0+00	8.46+03	2.03+05	2.3289+00	7.9129+00	1.9278-04	6.5706-04
1350	1.88+04	1.0+00	8.89+03	2.13+05	2.3244+00	7.8976+00	1.9254-04	6.5572-04
1360	1.88+04	1.0+00	9.34+03	2.24+05	2.3199+00	7.8823+00	1.9230-04	6.5438-04
1370	2.35+04	1.0+00	9.81+03	2.35+05	2.3154+00	7.8670+00	1.9207-04	6.5304-04
1380	2.35+04	1.0+00	1.03+04	2.47+05	2.3109+00	7.8518+00	1.9183-04	6.5170-04
1390	2.35+04	1.0+00	1.08+04	2.60+05	2.3064+00	7.8367+00	1.9159-04	6.5036-04
1400	2.35+04	1.0+00	1.14+04	2.72+05	2.3020+00	7.8216+00	1.9135-04	6.4902-04
1410	2.94+04	1.0+00	1.19+04	2.86+05	2.2976+00	7.8065+00	1.9111-04	6.4768-04
1420	2.94+04	1.0+00	1.25+04	3.00+05	2.2931+00	7.7915+00	1.9087-04	6.4634-04
1430	2.94+04	1.0+00	1.31+04	3.14+05	2.2887+00	7.7765+00	1.9063-04	6.4500-04
1440	2.94+04	1.0+00	1.37+04	3.30+05	2.2843+00	7.7616+00	1.9039-04	6.4366-04
1450	2.94+04	1.0+00	1.44+04	3.45+05	2.2800+00	7.7467+00	1.9015-04	6.4232-04
1460	3.67+04	1.0+00	1.51+04	3.62+05	2.2756+00	7.7319+00	1.8991-04	6.4098-04
1470	3.67+04	1.0+00	1.58+04	3.79+05	2.2713+00	7.7171+00	1.8967-04	6.3964-04
1480	3.67+04	1.0+00	1.66+04	3.97+05	2.2669+00	7.7024+00	1.8943-04	6.3830-04
1490	3.67+04	1.0+00	1.73+04	4.16+05	2.2626+00	7.6877+00	1.8919-04	6.3696-04
1500	3.67+04	1.0+00	1.81+04	4.35+05	2.2583+00	7.6731+00	1.8895-04	6.3562-04

Таблица 6

Параметры циклической коррекции для  $F_0 = 150 \cdot 10^{-22}$  Вт/м<sup>2</sup>·Гц и номинальной плотности атмосферы

Высота, км	Время существования, сут	Количество полных циклов	Средняя длина цикла		Средние затраты за цикл		Средние затраты за сутки	
			сут	ч	характеристическая скорость, м/с	топлива, кг	характеристическая скорость, м/с	топлива, кг
125	2.00+00	6.2+01	3.25-02	7.80 01	2.9196+00	9.9190+00	9.1883+01	3.0749+02
130	2.00+00	3.6+01	5.46-02	1.31+00	2.9551+00	1.0039+01	5.3650+01	1.8071+02
135	2.00+00	2.3+01	8.21-02	1.97+00	2.9713+00	1.0094+01	3.4352+01	1.1609+02
140	2.00+00	1.6+01	1.16-01	2.79+00	2.9785+00	1.0119+01	2.3913+01	8.0851+01
145	2.00+00	1.1+01	1.58-01	3.79+00	2.9826+00	1.0133+01	1.6442+01	5.5732+01
150	2.00+00	8.0+00	2.09-01	5.02+00	2.9838+00	1.0137+01	1.1953+01	4.0547+01
155	2.00+00	6.0+00	2.70-01	6.49+00	2.9834+00	1.0136+01	8.9592+00	3.0407+01
160	2.00+00	4.0+00	3.44-01	8.25+00	2.9830+00	1.0134+01	5.9689+00	2.0268+01
165	2.00+00	3.0+00	4.31-01	1.03+01	2.9810+00	1.0128+01	4.4727+00	1.5191+01
170	2.00+00	2.0+00	5.34-01	1.28+01	2.9791+00	1.0121+01	2.9791+00	1.0121+01
175	2.00+00	2.0+00	6.54-01	1.57+01	2.9757+00	1.0109+01	2.9757+00	1.0109+01
180	2.00+00	1.0+00	8.06-01	1.93+01	2.9736+00	1.0102+01	1.4894+00	5.0512+00
185	2.00+00	1.0+00	9.56-01	2.29+01	2.9702+00	1.0091+01	1.4847+00	5.0454+00
190	2.50+00	1.0+00	1.13+00	2.71+01	2.9668+00	1.0079+01	1.1884+00	4.0317+00
195	3.12+00	1.0+00	1.32+00	3.17+01	2.9634+00	1.0068+01	9.4798-01	3.2217-00
200	3.12+00	1.0+00	1.54+00	3.71+01	2.9601+00	1.0056-01	9.4690-01	3.2180+00
205	3.91+00	1.0+00	1.80+00	4.31+01	2.9567+00	1.0045+01	7.5693-01	2.5715+00
210	4.88+00	1.0+00	2.08+00	4.99+01	2.9533+00	1.0033+01	6.0160-01	2.0549+00
215	4.88+00	1.0+00	2.40+00	5.76+01	2.9500+00	1.0022+01	6.0391-01	2.0525+00
220	6.10+00	1.0+00	2.76+00	6.62+01	2.9466+00	1.0011+01	4.8257-01	1.6402+00
225	7.63+00	1.0+00	3.16+00	7.58+01	2.9433+00	9.9993+00	3.8561-01	1.3106+00
230	7.63+00	1.0+00	3.61+00	8.66+01	2.9399+00	9.9890+00	3.8517-01	1.3091-00
235	9.54+00	1.0+00	4.11+00	9.86+01	2.9366+00	9.9767+00	3.0779-01	1.0461+00

Высота, км	Время существования, сут	Количество полных циклов	Средняя длина цикла		Средние затраты на цикл		Средние затраты за сутки	
			сут	ч	характеристическая скорость, м/с	топлива, кг	характеристическая скорость, м/с	топлива, кг
240	9.54+00	1.0+00	4.67+00	1.12+02	2.9333+00	9.9654+00	3.0744-01	1.0449+00
245	1.19+01	1.0+00	5.29+00	1.27+02	2.9299+00	9.9541+00	2.4567-01	8.3501-01
250	1.49+01	1.0+00	5.98+00	1.44+02	2.9266+00	9.9428+00	1.9631-01	6.6725-01
255	1.49+01	1.0+00	6.75+00	1.62+02	2.9233+00	9.9316+00	1.9609-01	6.6650-01
260	1.86+01	1.0+00	7.60+00	1.82+02	2.9200+00	9.9204+00	1.5669-01	5.3260-01
265	1.86+01	1.0+00	8.54+00	2.05+02	2.9167+00	9.9092+00	1.5652-01	5.3199-01
270	2.33+01	1.0+00	9.57+00	2.30+02	2.9134+00	9.8980+00	1.2507-01	4.2512-01
275	2.33+01	1.0+00	1.07+01	2.57+02	2.9101+00	9.8868+00	1.2493-01	4.2464-01
280	2.91+01	1.0+00	1.20+01	2.87+02	2.9069+00	9.8757+00	9.9831-02	3.3933-01
285	2.91+01	1.0+00	1.34+01	3.21+02	2.9036+00	9.8646+00	9.9719-02	3.3894-01
290	3.64+01	1.0+00	1.49+01	3.57+02	2.9003+00	9.8535+00	7.9385-02	2.7085-01
295	3.64+01	1.0+00	1.65+01	3.97+02	2.8971+00	9.8424+00	7.9596-02	2.7055-01
300	4.55+01	1.0+00	1.84+01	4.41+02	2.8938+00	9.8314+00	6.3605-02	2.1619-01
310	4.55+01	1.0+00	2.26+01	5.41+02	2.8873+00	9.8093+00	6.3462-02	2.1571-01
320	5.68+01	1.0+00	2.76+01	6.62+02	2.8809+00	9.7874+00	5.0856-02	1.7218-01
330	7.11+01	1.0+00	3.35+01	8.04+02	2.8744+00	9.7655+00	4.0434-02	1.3744-01
340	8.88+01	1.0+00	4.06+01	9.74+02	2.8680+00	9.7437+00	3.2375-02	1.0970-01
350	1.11+02	1.0+00	4.89+01	1.17+03	2.8616+00	9.7220+00	2.5763-02	8.7568-02
360	1.39+02	1.0+00	5.87+01	1.41+03	2.8552+00	9.7004+00	2.0564-02	6.9898-02
370	1.73+02	1.0+00	7.02+01	1.69+03	2.8489+00	9.6788+00	1.6415-02	5.5795-02
380	1.73+02	1.0+00	8.37+01	2.01+03	2.8426+00	9.6573+00	1.6378-02	5.5671-02
390	2.17+02	1.0+00	9.95+01	2.39+03	2.8363+00	9.6359+00	1.3074-02	4.4438-02
400	2.17+02	2.0+02	1.18+00	2.83+01	2.8300+00	9.6145+00	2.3864+00	8.1084+00
410	2.17+02	1.7+02	1.39+00	3.34+01	2.8237+00	9.5931+00	2.0103+00	6.8306+00
420	2.17+02	1.4+02	1.64+00	3.94+01	2.8174+00	9.5717+00	1.7031+00	5.7872+00
430	2.17+02	1.2+02	1.93+00	4.62+01	2.8111+00	9.5503+00	1.4473+00	4.9181+00
440	2.17+02	9.9+01	2.26+00	5.42+01	2.8048+00	9.5289+00	1.2225+00	4.1544+00
450	2.17+02	8.4+01	2.64+00	6.33+01	2.7985+00	9.5075+00	1.0424+00	3.5242+00
460	2.17+02	7.1+01	3.08+00	7.38+01	2.7922+00	9.4861+00	8.8454-01	3.0061+00
470	2.17+02	6.1+01	3.58+00	8.59+01	2.7859+00	9.4647+00	7.6189-01	2.5894+00
480	2.17+02	5.2+01	4.16+00	9.98+01	2.7796+00	9.4433+00	6.5083-01	2.2119+00
490	2.17+02	4.4+01	4.82+00	1.16+02	2.7733+00	9.4219+00	5.5158-01	1.8747+00
500	2.17+02	3.8+01	5.57+00	1.34+02	2.7670+00	9.4005+00	4.7667-01	1.6201+00
510	2.17+02	3.3+01	6.43+00	1.54+02	2.7607+00	9.3791+00	4.1403-01	1.4072+00
520	2.17+02	2.8+01	7.41+00	1.78+02	2.7544+00	9.3577+00	3.5136-01	1.1942+00
530	2.17+02	2.4+01	8.52+00	2.05+02	2.7481+00	9.3363+00	3.0108-01	1.0233+00
540	2.17+02	2.1+01	9.79+00	2.35+02	2.7418+00	9.3149+00	2.6324-01	8.9474-01
550	2.17+02	1.8+01	1.12+01	2.69+02	2.7355+00	9.2935+00	2.2546-01	7.6634-01
560	2.17+02	1.6+01	1.28+01	3.08+02	2.7292+00	9.2721+00	2.0017-01	6.8036-01
570	2.17+02	1.3+01	1.47+01	3.52+02	2.7229+00	9.2507+00	1.6251-01	5.5237-01
580	2.17+02	1.2+01	1.68+01	4.02+02	2.7166+00	9.1981+00	1.4976-01	5.0902-01
590	2.17+02	1.0+01	1.91+01	4.58+02	2.7103+00	9.1868+00	1.2465-01	4.2367-01
600	2.17+02	9.0+00	2.17+01	5.22+02	2.7040+00	9.1754+00	1.1199-01	3.8056-01
610	2.17+02	8.0+00	2.39+01	5.73+02	2.6977+00	9.1540+00	9.9381-02	3.3780-01
620	2.17+02	7.0+00	2.68+01	6.42+02	2.6914+00	9.1326+00	8.6812-02	2.9507-01
630	2.17+02	6.0+00	2.99+01	7.18+02	2.6851+00	9.1112+00	7.4285-02	2.5250-01
640	2.17+02	5.0+00	3.34+01	8.02+02	2.6788+00	9.0898+00	6.1800-02	2.1006-01
650	2.17+02	4.0+00	3.72+01	8.93+02	2.6725+00	9.0684+00	4.9357-02	1.6777-01
660	2.17+02	4.0+00	4.14+01	9.93+02	2.6662+00	9.0470+00	4.9252-02	1.6741-01
670	2.17+02	3.0+00	4.59+01	1.10+03	2.6599+00	9.0256+00	3.6877-02	1.2535-01
680	2.17+02	3.0+00	5.08+01	1.22+03	2.6536+00	9.0042+00	3.6799-02	1.2508-01
690	2.17+02	2.0+00	5.62+01	1.35+03	2.6473+00	8.9828+00	2.4491-02	8.3246-02
700	2.17+02	2.0+00	6.21+01	1.49+03	2.6410+00	8.9614+00	2.4439-02	8.3069-02
710	2.17+02	2.0+00	6.84+01	1.64+03	2.6347+00	8.9400+00	2.4387-02	8.2834-02
720	2.17+02	1.0+00	7.53+01	1.81+03	2.6284+00	8.9186+00	1.2173-02	4.1376-02
730	2.17+02	1.0+00	8.28+01	1.99+03	2.6221+00	8.8972+00	1.2147-02	4.1288-02
740	2.17+02	1.0+00	9.09+01	2.18+03	2.6158+00	8.8758+00	1.2121-02	4.1201-02
750	2.17+02	1.0+00	9.96+01	2.39+03	2.6095+00	8.8544+00	1.2096-02	4.1115-02
760	2.71+02	1.0+00	1.09+02	2.62+03	2.6032+00	8.8330+00	9.6564-03	3.2823-02
770	2.71+02	1.0+00	1.19+02	2.85+03	2.5969+00	8.8116+00	9.6332-03	3.2754-02
780	2.71+02	1.0+00	1.30+02	3.13+03	2.5906+00	8.7902+00	9.6100-03	3.2685-02
790	3.39+02	1.0+00	1.42+02	3.42+03	2.5843+00	8.7688+00	7.6767-03	2.6093-02
800	3.39+02	1.0+00	1.55+02	3.72+03	2.5780+00	8.7474+00	7.6607-03	2.6039-02
810	3.39+02	1.0+00	1.69+02	4.06+03	2.5717+00	8.7260+00	7.6447-03	2.5985-02



Высота, км	Время существования, сут	Количество полных циклов	Средняя длина цикла		Средние затраты за цикл		Средние затраты за сутки	
			сут	ч	характеристической скорости, м/с	топлива, кг	характеристической скорости, м/с	топлива, кг
820	4.24+02	1.0+00	1.81+02	4.41+03	2.5839+00	8.7856+00	6.1030-03	2.0744-02
830	4.24+02	1.0+00	2.00+02	4.80+03	2.5805+00	8.7673+00	6.0903-03	2.0701-02
840	5.29+02	1.0+00	2.17+02	5.21+03	2.5751+00	8.7491+00	4.8521-03	1.6527-02
850	5.29+02	1.0+00	2.36+02	5.65+03	2.5698+00	8.7310+00	4.8520-03	1.6492-02
860	5.29+02	1.0+00	2.55+02	6.13+03	2.5644+00	8.7129+00	4.8120-03	1.6458-02
870	6.62+02	1.0+00	2.77+02	6.64+03	2.5591+00	8.6949+00	3.8656-03	1.3139-02
880	6.62+02	1.0+00	3.00+02	7.19+03	2.5538+00	8.6769+00	3.8576-03	1.3112-02
890	6.62+02	1.0+00	3.24+02	7.78+03	2.5485+00	8.6590+00	3.8193-03	1.3085-02
900	8.27+02	1.0+00	3.50+02	8.40+03	2.5433+00	8.6412+00	3.0734-03	1.0147-02
910	8.27+02	1.0+00	3.78+02	9.08+03	2.5381+00	8.6234+00	3.0670-03	1.0425-02
920	8.27+02	1.0+00	4.08+02	9.80+03	2.5329+00	8.6057+00	3.0607-03	1.0404-02
930	1.03-03	1.0+00	4.40+02	1.06+04	2.5277+00	8.5880+00	2.4436-03	8.3058-03
940	1.03+03	1.0+00	4.74+02	1.14+04	2.5225+00	8.5704+00	2.4388-03	8.2888-03
950	1.03+03	1.0+00	5.11+02	1.23+04	2.5173+00	8.5529+00	2.4336-03	8.2718-03
960	1.29+03	1.0+00	5.50+02	1.32+04	2.5122+00	8.5354+00	1.9429-03	6.6010-03
970	1.29+03	1.0+00	5.91+02	1.42+04	2.5071+00	8.5180+00	1.9389-03	6.5905-03
980	1.29+03	1.0+00	6.36+02	1.53+04	2.5019+00	8.5006+00	1.9350-03	6.5771-03
990	1.62+03	1.0+00	6.83+02	1.64+04	2.4969+00	8.4833+00	1.5448-03	5.2509-03
1000	1.62+03	1.0+00	7.33+02	1.76+04	2.4918+00	8.4661+00	1.5417-03	5.2403-03
1010	1.62+03	1.0+00	7.87+02	1.89+04	2.4867+00	8.4489+00	1.5385-03	5.2296-03
1020	2.02+03	1.0+00	8.44+02	2.03+04	2.4817+00	8.4318+00	1.2281-03	4.1752-03
1030	2.02+03	1.0+00	9.05+02	2.17+04	2.4767+00	8.4147+00	1.2259-03	4.1668-03
1040	2.02+03	1.0+00	9.69+02	2.33+04	2.4716+00	8.3977+00	1.2234-03	4.1581-03
1050	2.52+03	1.0+00	1.04+03	2.49+04	2.4667+00	8.3808+00	9.7674-04	3.3200-03
1050	2.52+03	1.0+00	1.11+03	2.67+04	2.4617+00	8.3639+00	9.7477-04	3.3133-03
1070	2.52+03	1.0+00	1.19+03	2.85+04	2.4567+00	8.3470+00	9.7280-04	3.3066-03
1080	3.16+03	1.0+00	1.27+03	3.05+04	2.4518+00	8.3303+00	7.7668-04	2.6400-03
1090	3.16+03	1.0+00	1.36+03	3.26+04	2.4469+00	8.3135+00	7.7512-04	2.6347-03
1100	3.16+03	1.0+00	1.45+03	3.48+04	2.4419+00	8.2969+00	7.7357-04	2.6294-03
1110	3.16+03	1.0+00	1.55+03	3.72+04	2.4371+00	8.2803+00	7.7201-04	2.6241-03
1120	3.94+03	1.0+00	1.65+03	3.97+04	2.4322+00	8.2637+00	6.1638-04	2.0951-03
1130	3.94+03	1.0+00	1.76+03	4.23+04	2.4273+00	8.2472+00	6.1515-04	2.0909-03
1140	3.94+03	1.0+00	1.88+03	4.51+04	2.4225+00	8.2307+00	6.1392-04	2.0857-03
1150	4.93+03	1.0+00	2.00+03	4.81+04	2.4177+00	8.2144+00	4.9016-04	1.6661-03
1160	4.93+03	1.0+00	2.14+03	5.13+04	2.4128+00	8.1983+00	4.8918-04	1.6628-03
1170	4.93+03	1.0+00	2.27+03	5.46+04	2.4080+00	8.1817+00	4.8821-04	1.6595-03
1180	4.93+03	1.0+00	2.42+03	5.81+04	2.4033+00	8.1655+00	4.8724-04	1.6562-03
1190	6.16+03	1.0+00	2.58+03	6.18+04	2.3985+00	8.1493+00	3.8302-04	1.3223-03
1200	6.16+03	1.0+00	2.74+03	6.58+04	2.3938+00	8.1332+00	3.8825-04	1.3197-03
1210	6.16+03	1.0+00	2.91+03	7.00+04	2.3890+00	8.1171+00	3.8749-04	1.3171-03
1220	7.70+03	1.0+00	3.10+03	7.44+04	2.3843+00	8.1011+00	3.0938-04	1.0516-03
1230	7.70+03	1.0+00	3.29+03	7.90+04	2.3796+00	8.0851+00	3.0877-04	1.0495-03
1240	7.70+03	1.0+00	3.50+03	8.39+04	2.3749+00	8.0692+00	3.0816-04	1.0474-03
1250	7.70+03	1.0+00	3.71+03	8.91+04	2.3703+00	8.0534+00	3.0756-04	1.0454-03
1260	9.63+03	1.0+00	3.94+03	9.46+04	2.3656+00	8.0376+00	2.4556-04	8.3467-04
1270	9.63+03	1.0+00	4.18+03	1.00+05	2.3610+00	8.0218+00	2.4508-04	8.3303-04
1280	9.63+03	1.0+00	4.44+03	1.06+05	2.3563+00	8.0061+00	2.4460-04	8.3140-04
1290	9.63+03	1.0+00	4.70+03	1.13+05	2.3517+00	7.9904+00	2.4412-04	8.2977-04
1300	1.20+04	1.0+00	4.99+03	1.20+05	2.3471+00	7.9748+00	1.9492-04	6.6252-04
1310	1.20+04	1.0+00	5.29+03	1.27+05	2.3425+00	7.9593+00	1.9454-04	6.6123-04
1320	1.20+04	1.0+00	5.60+03	1.34+05	2.3380+00	7.9438+00	1.9416-04	6.5994-04
1330	1.20+04	1.0+00	5.93+03	1.42+05	2.3334+00	7.9283+00	1.9378-04	6.5866-04
1340	1.50+04	1.0+00	6.28+03	1.51+05	2.3289+00	7.9129+00	1.5472-04	5.2590-04
1350	1.50+04	1.0+00	6.65+03	1.60+05	2.3244+00	7.8976+00	1.5442-04	5.2488-04
1360	1.50+04	1.0+00	7.03+03	1.69+05	2.3199+00	7.8823+00	1.5412-04	5.2387-04
1370	1.50+04	1.0+00	7.44+03	1.79+05	2.3154+00	7.8670+00	1.5382-04	5.2285-04
1380	1.88+04	1.0+00	7.87+03	1.89+05	2.3109+00	7.8518+00	1.2282-04	4.1747-04
1390	1.88+04	1.0+00	8.32+03	2.00+05	2.3064+00	7.8367+00	1.2259-04	4.1667-04
1400	1.88+04	1.0+00	8.79+03	2.11+05	2.3020+00	7.8216+00	1.2235-04	4.1586-04
1410	1.88+04	1.0+00	9.29+03	2.23+05	2.2976+00	7.8065+00	1.2211-04	4.1506-04
1420	2.35+04	1.0+00	9.81+03	2.36+05	2.2931+00	7.7915+00	9.7504-05	3.3141-04
1430	2.35+04	1.0+00	1.04+04	2.49+05	2.2887+00	7.7765+00	9.7318-05	3.3078-04
1440	2.35+04	1.0+00	1.09+04	2.63+05	2.2843+00	7.7616+00	9.7130-05	3.3014-04
1450	2.35+04	1.0+00	1.16+04	2.77+05	2.2800+00	7.7467+00	9.6944-05	3.2951-04
1460	2.91+04	1.0+00	1.22+04	2.93+05	2.2756+00	7.7319+00	7.7403-05	2.6310-04
1470	2.91+04	1.0+00	1.29+04	3.09+05	2.2713+00	7.7171+00	7.7259-05	2.6260-04
1480	2.91+04	1.0+00	1.36+04	3.26+05	2.2669+00	7.7024+00	7.7116-05	2.6210-04
1490	2.94+04	1.0+00	1.43+04	3.43+05	2.2626+00	7.6877+00	7.6965-05	2.6160-04
1500	3.67+04	1.0+00	1.51+04	3.62+05	2.2583+00	7.6731+00	6.1457-05	2.6888-04

Параметры циклической коррекции для  $F_0 = 175 \cdot 10^{-22}$  Вт/м<sup>2</sup>·Гц и номинальной плотности атмосферы

Высота, км	Время существования, сут	Количество полных циклов	Средняя длина цикла		Средние затраты за цикл		Средние затраты за сутки	
			сут	ч	характеристическая скорость, м/с	топлива, кг	характеристическая скорость, м/с	топлива, кг
125	2.00+00	6.2+01	3.725-02	7.79-01	2.9196+00	9.9190+00	9.1883+01	3.0749+02
130	2.00+00	3.6+01	5.42-02	1.30+00	2.9551+00	1.0039+01	5.3650+01	1.8071+02
135	2.01+00	2.4+01	8.10-02	1.94+00	2.9698+00	1.0089+01	3.5817+01	1.2107+02
140	2.00+00	1.6+01	1.14-01	2.73+00	2.9785+00	1.0119+01	2.3913+01	8.0951+01
145	2.00+00	1.2+01	1.54-01	3.69+00	2.9811+00	1.0128+01	1.7932+01	6.0767+01
150	2.00+00	8.0+00	2.02-01	4.85+00	2.9838+00	1.0137+01	1.1953+01	4.0547+01
155	2.00+00	6.0+00	2.60-01	6.24+00	2.9834+00	1.0136+01	8.9592+00	3.0407+01
160	2.00+00	5.0+00	3.29-01	7.89+00	2.9815+00	1.0129+01	7.4593+00	2.5323+01
165	2.00+00	3.0+00	4.10-01	9.84+00	2.9810+00	1.0128+01	4.4727+00	1.5191+01
170	2.00+00	2.0+00	5.05-01	1.21+01	2.9791+00	1.0121+01	2.9791+00	1.0121+01
175	2.00+00	2.0+00	6.16-01	1.48+01	2.9757+00	1.0109+01	2.9757+00	1.0109+01
180	2.00+00	1.0+00	7.55-01	1.81+01	2.9736+00	1.0102+01	1.4854+00	5.0512+00
185	2.00+00	1.0+00	8.91-01	2.14+01	2.9702+00	1.0091+01	1.4847+00	5.0454+00
190	2.50+00	1.0+00	1.04+00	2.51+01	2.9658+00	1.0079+01	1.1874+00	4.0317+00
195	2.50+00	1.0+00	1.22+00	2.92+01	2.9634+00	1.0068+01	1.1850+00	4.0277+00
200	3.12+00	1.0+00	1.41+00	3.39+01	2.9601+00	1.0056+01	9.4090-01	3.2180+00
205	3.91+00	1.0+00	1.63+00	3.92+01	2.9567+00	1.0045+01	7.5693-01	2.5715+00
210	3.91+00	1.0+00	1.88+00	4.52+01	2.9533+00	1.0033+01	7.5577-01	2.5686+00
215	4.88+00	1.0+00	2.16+00	5.18+01	2.9500+00	1.0022+01	6.0391-01	2.0325+00
220	6.10+00	1.0+00	2.47+00	5.92+01	2.9469+00	1.0011+01	4.8257-01	1.6402+00
225	6.10+00	1.0+00	2.81+00	6.74+01	2.9433+00	9.9993+00	4.8202-01	1.6383+00
230	7.63+00	1.0+00	3.19+00	7.56+01	2.9399+00	9.9880+00	3.8517-01	1.3091+00
235	7.63+00	1.0+00	3.62+00	8.68+01	2.9366+00	9.9767+00	3.8174-01	1.3077+00
240	9.54+00	1.0+00	4.09+00	9.81+01	2.933+00	9.9654+00	3.0744-01	1.0449+00
245	9.54+00	1.0+00	4.60+00	1.11+02	2.9299+00	9.9541+00	3.0709-01	1.0438+00
250	1.19+01	1.0+00	5.18+00	1.24+02	2.9266+00	9.9428+00	2.4539-01	8.3406-01
255	1.19+01	1.0+00	5.81+00	1.39+02	2.9233+00	9.9316+00	2.4511-01	8.3312-01
260	1.49+01	1.0+00	6.51+00	1.56+02	2.9200+00	9.9204+00	1.9587-01	6.6574-01
265	1.49+01	1.0+00	7.27+00	1.74+02	2.9167+00	9.9092+00	1.9565-01	6.6499-01
270	1.86+01	1.0+00	8.11+00	1.95+02	2.9134+00	9.8980+00	1.5634-01	5.3139-01
275	1.86+01	1.0+00	9.03+00	2.17+02	2.9101+00	9.8868+00	1.5616-01	5.3080-01
280	2.33+01	1.0+00	1.00+01	2.41+02	2.9069+00	9.8757+00	1.2479-01	4.2416-01
285	2.33+01	1.0+00	1.11+01	2.67+02	2.9036+00	9.8646+00	1.2465-01	4.2368-01
290	2.91+01	1.0+00	1.23+01	2.95+02	2.9003+00	9.8535+00	9.9607-02	3.3855-01
295	2.91+01	1.0+00	1.37+01	3.28+02	2.8971+00	9.8421+00	9.9495-02	3.3818-01
300	3.64+01	1.0+00	1.51+01	3.62+02	2.8938+00	9.8311+00	7.9506-02	2.7024-01
310	4.55+01	1.0+00	1.84+01	4.41+02	2.8903+00	9.8093+00	6.3462-02	2.1571-01
320	4.55+01	1.0+00	2.22+01	5.33+02	2.8869+00	9.7874+00	6.3320-02	2.1523-01
330	5.68+01	1.0+00	2.68+01	6.42+02	2.8744+00	9.7655+00	5.0543-02	1.7180-01
340	7.11+01	1.0+00	3.21+01	7.70+02	2.8580+00	9.7437+00	4.0344-02	1.3713-01
350	8.88+01	1.0+00	3.83+01	9.20+02	2.8516+00	9.7220+00	3.2203-02	1.0946-01
360	1.11+02	1.0+00	4.56+01	1.09+03	2.8552+00	9.7004+00	2.5705-02	8.7373-02
370	1.11+02	1.0+00	5.41+01	1.30+03	2.8489+00	9.6788+00	2.5648-02	8.7179-02
380	1.39+02	1.0+00	6.39+01	1.53+03	2.8426+00	9.6573+00	2.0473-02	6.9588-02
390	1.73+02	1.0+00	7.53+01	1.81+03	2.8363+00	9.6359+00	1.6342-02	5.5547-02
400	1.73+02	2.2+02	8.84+01	2.12+03	2.8567+00	8.6856+00	3.1878+00	1.0816+01
410	1.73+02	1.8+02	1.04+02	2.49+01	2.5935+00	8.8115+00	2.7051+00	9.1938+00
420	1.73+02	1.5+02	1.21+02	2.90+01	2.6222+00	8.9092+00	2.3127+00	7.8578+00
430	1.73+02	1.3+02	1.41+02	3.38+01	2.6464+00	8.9912+00	1.9677+00	6.6861+00
440	1.73+02	1.1+02	1.64+02	3.93+01	2.6645+00	9.0527+00	1.6893+00	5.7404+00
450	1.73+02	9.4+01	1.90+02	4.56+01	2.6789+00	9.1017+00	1.4513+00	4.9320+00
460	1.73+02	8.0+01	2.20+02	5.28+01	2.6909+00	9.1423+00	1.2407+00	4.2162+00
470	1.73+02	6.9+01	2.54+02	6.09+01	2.6991+00	9.1701+00	1.0733+00	3.6475+00
480	1.73+02	5.9+01	2.93+02	7.01+01	2.7060+00	9.1936+00	9.2007-01	3.1269+00
490	1.73+02	5.1+01	3.36+02	8.07+01	2.7104+00	9.2085+00	7.9658-01	2.7072+00
500	1.73+02	4.4+01	3.85+02	9.27+01	2.7135+00	9.2190+00	6.8801-01	2.3283+00
510	1.73+02	3.8+01	4.43+02	1.05+02	2.7153+00	9.2251+00	5.9158-01	2.0208+00
520	1.73+02	3.3+01	5.03+02	1.21+02	2.7158+00	9.2269+00	5.1644-01	1.7552+00
530	1.73+02	2.9+01	5.78+02	1.39+02	2.7150+00	9.2243+00	4.5371-01	1.5421+00
540	1.73+02	2.5+01	6.59+02	1.58+02	2.7143+00	9.2217+00	3.9101-01	1.3290+00
550	1.73+02	2.2+01	7.50+02	1.80+02	2.7122+00	9.2147+00	3.4383-01	1.1686+00
560	1.73+02	1.9+01	8.53+02	2.05+02	2.7102+00	9.2078+00	2.9672-01	1.0085+00
570	1.73+02	1.7+01	9.68+02	2.32+02	2.7069+00	9.1966+00	2.6516-01	9.0125-01



Продолжение табл. 7

Высота, км	Время существования, сут	Количество полных циклов	Средняя длина цикла		Средние затраты на цикл		Средние затраты за сутки	
			сут	ч	характеристическая скорость, м/с	топлива, кг	характеристическая скорость, м/с	топлива, кг
580	1.73+02	1.4+01	1.10+01	2.63+02	2.7048+00	9.1896+00	2.1820-01	7.4164-01
590	1.73+02	1.3+01	1.24+01	2.98+02	2.7003+00	9.1742+00	2.0227-01	6.8751-01
600	1.73+02	1.1+01	1.40+01	3.37+02	2.6970+00	9.1630+00	1.7094-01	5.8103-01
610	1.73+02	1.0+01	1.55+01	3.72+02	2.6924+00	9.1476+00	1.5514-01	5.2732-01
620	1.73+02	9.0+00	1.72+01	4.13+02	2.6879+00	9.1322+00	1.3939-01	4.7379-01
630	1.73+02	8.0+00	1.91+01	4.57+02	2.6834+00	9.1169+00	1.2370-01	4.2044-01
640	1.73+02	7.0+00	2.11+01	5.05+02	2.6789+00	9.1016+00	1.0805-01	3.6727-01
650	1.73+02	6.0+00	2.33+01	5.59+02	2.6744+00	9.0834+00	9.2462-02	3.1428-01
660	1.73+02	5.0+00	2.57+01	6.17+02	2.6699+00	9.0712+00	7.6922-02	2.6146-01
670	1.73+02	5.0+00	2.83+01	6.80+02	2.6643+00	9.0519+00	7.6759-02	2.6090-01
680	1.73+02	4.0+00	3.12+01	7.48+02	2.6598+00	9.0368+00	6.1304-02	2.0837-01
690	1.73+02	4.0+00	3.43+01	8.23+02	2.6542+00	9.0176+00	6.1174-02	2.0793-01
700	1.73+02	3.0+00	3.76+01	9.03+02	2.6497+00	9.0025+00	4.5804-02	1.5569-01
710	1.73+02	3.0+00	4.13+01	9.91+02	2.6441+00	8.9835+00	4.5707-02	1.5536-01
720	1.73+02	2.0+00	4.53+01	1.09+03	2.6397+00	8.9681+00	3.0420-02	1.0340-01
730	1.73+02	2.0+00	4.93+01	1.19+03	2.6341+00	8.9495+00	3.0356-02	1.0318-01
740	1.73+02	2.0+00	5.42+01	1.30+03	2.6286+00	8.9306+00	3.0292-02	1.0296-01
750	1.73+02	1.0+00	5.93+01	1.42+03	2.6241+00	8.9153+00	1.5120-02	5.1393-02
760	1.73+02	1.0+00	6.48+01	1.55+03	2.6185+00	8.8966+00	1.5088-02	5.1285-02
770	1.73+02	1.0+00	7.07+01	1.70+03	2.6130+00	8.8779+00	1.5057-02	5.1178-02
780	1.73+02	1.0+00	7.70+01	1.85+03	2.6076+00	8.8593+00	1.5025-02	5.1071-02
790	1.73+02	1.0+00	8.39+01	2.01+03	2.6021+00	8.8408+00	1.4994-02	5.0964-02
800	2.17+02	1.0+00	9.13+01	2.19+03	2.5967+00	8.8224+00	1.1970-02	4.0686-02
810	2.17+02	1.0+00	9.93+01	2.38+03	2.5913+00	8.8040+00	1.1945-02	4.0601-02
820	2.17+02	1.0+00	1.08+02	2.59+03	2.5859+00	8.7856+00	1.1920-02	4.0516-02
830	2.17+02	1.0+00	1.17+02	2.81+03	2.5805+00	8.7673+00	9.5161-03	3.2346-02
840	2.17+02	1.0+00	1.27+02	3.05+03	2.5751+00	8.7491+00	9.4964-03	3.2279-02
850	3.39+02	1.0+00	1.38+02	3.31+03	2.5698+00	8.7310+00	7.5813-03	2.5769-02
860	3.39+02	1.0+00	1.50+02	3.59+03	2.5644+00	8.7129+00	7.5666-03	2.5716-02
870	3.39+02	1.0+00	1.62+02	3.89+03	2.5591+00	8.6949+00	7.5500-03	2.5663-02
880	4.24+02	1.0+00	1.75+02	4.21+03	2.5538+00	8.6769+00	6.0275-03	2.0489-02
890	4.24+02	1.0+00	1.90+02	4.55+03	2.5486+00	8.6590+00	6.0151-03	2.0446-02
900	4.24+02	1.0+00	2.05+02	4.92+03	2.5433+00	8.6412+00	6.0027-03	2.0403-02
910	5.29+02	1.0+00	2.22+02	5.32+03	2.5381+00	8.6234+00	4.7923-03	1.6289-02
920	5.29+02	1.0+00	2.39+02	5.74+03	2.5329+00	8.6057+00	4.7824-03	1.6256-02
930	5.29+02	1.0+00	2.58+02	6.20+03	2.5277+00	8.5880+00	4.7726-03	1.6222-02
940	6.62+02	1.0+00	2.79+02	6.69+03	2.5225+00	8.5704+00	3.8103-03	1.2951-02
950	6.62+02	1.0+00	3.00+02	7.21+03	2.5173+00	8.5529+00	3.8025-03	1.2925-02
960	6.62+02	1.0+00	3.24+02	7.76+03	2.5122+00	8.5354+00	3.7947-03	1.2898-02
970	8.27+02	1.0+00	3.48+02	8.36+03	2.5071+00	8.5180+00	3.0296-03	1.0298-02
980	8.27+02	1.0+00	3.75+02	9.00+03	2.5019+00	8.5006+00	3.0234-03	1.0277-02
990	8.27+02	1.0+00	4.03+02	9.68+03	2.4969+00	8.4833+00	3.0172-03	1.0256-02
1000	1.03+03	1.0+00	4.34+02	1.04+04	2.4918+00	8.4661+00	2.4089-03	8.1879-03
1010	1.03+03	1.0+00	4.66+02	1.12+04	2.4867+00	8.4489+00	2.4040-03	8.1713-03
1020	1.03+03	1.0+00	5.01+02	1.21+04	2.4817+00	8.4318+00	2.3991-03	8.1547-03
1030	1.29+03	1.0+00	5.38+02	1.29+04	2.4767+00	8.4147+00	1.9154-03	6.5106-03
1040	1.29+03	1.0+00	5.77+02	1.38+04	2.4717+00	8.3977+00	1.9115-03	6.4974-03
1050	1.29+03	1.0+00	6.19+02	1.49+04	2.4667+00	8.3808+00	1.9077-03	6.4843-03
1060	1.62+03	1.0+00	6.64+02	1.59+04	2.4617+00	8.3639+00	1.5231-03	5.1770-03
1070	1.62+03	1.0+00	7.11+02	1.71+04	2.4567+00	8.3470+00	1.5200-03	5.1666-03
1080	1.62+03	1.0+00	7.62+02	1.83+04	2.4518+00	8.3303+00	1.5169-03	5.1562-03
1090	2.02+03	1.0+00	8.16+02	1.96+04	2.4469+00	8.3135+00	1.2111-03	4.1167-03
1100	2.02+03	1.0+00	8.74+02	2.10+04	2.4419+00	8.2969+00	1.2087-03	4.1084-03
1110	2.02+03	1.0+00	9.35+02	2.24+04	2.4371+00	8.2803+00	1.2053-03	4.1002-03
1120	2.02+03	1.0+00	1.00+03	2.40+04	2.4322+00	8.2637+00	1.2039-03	4.0920-03
1130	2.52+03	1.0+00	1.07+03	2.57+04	2.4273+00	8.2472+00	9.6117-04	3.2671-03
1140	2.52+03	1.0+00	1.14+03	2.74+04	2.4225+00	8.2307+00	9.5925-04	3.2605-03
1150	2.52+03	1.0+00	1.22+03	2.93+04	2.4177+00	8.2144+00	9.5734-04	3.2540-03
1160	3.16+03	1.0+00	1.30+03	3.13+04	2.4128+00	8.1980+00	7.6435-04	2.5981-03
1170	3.16+03	1.0+00	1.39+03	3.34+04	2.4080+00	8.1817+00	7.6283-04	2.5929-03
1180	3.16+03	1.0+00	1.49+03	3.57+04	2.4033+00	8.1655+00	7.6132-04	2.5878-03
1190	3.94+03	1.0+00	1.38+03	3.80+04	2.3985+00	8.1493+00	6.0785-04	2.0661-03
1200	3.94+03	1.0+00	1.69+03	4.06+04	2.3939+00	8.1332+00	6.0364-04	2.0620-03
1210	3.94+03	1.0+00	1.80+03	4.32+04	2.3890+00	8.1171+00	6.0544-04	2.0579-03

Высота, км	Время существования, сут	Количество полных циклов	Средняя длина цикла		Средние затраты за цикл		Средние затраты за сутки	
			сут	ч	характеристическая скорость, м/с	топлива, кг	характеристическая скорость, м/с	топлива, кг
1220	3.94+03	1.0+00	1.92+03	4.61+04	2.3813+00	8.1011+00	6.0425-04	2.0539-03
1230	4.93+03	1.0+00	2.05+03	4.91+04	2.3796+00	8.0871+00	4.8245-04	1.6399-03
1240	4.93+03	1.0+00	2.18+03	5.23+04	2.3749+00	8.0692+00	4.8150-04	1.6366-03
1250	4.93+03	1.0+00	2.32+03	5.57+04	2.3703+00	8.0534+00	4.8955-04	1.6334-03
1260	6.16+03	1.0+00	2.47+03	5.93+04	2.3656+00	8.0376+00	3.8369-04	1.3012-03
1270	6.16+03	1.0+00	2.63+03	6.31+04	2.3610+00	8.0218+00	3.8293-04	1.3015-03
1280	6.16+03	1.0+00	2.89+03	6.71+04	2.3563+00	8.0061+00	3.8219-04	1.2991-03
1290	6.16+03	1.0+00	2.97+03	7.14+04	2.3517+00	7.9904+00	3.8144-04	1.2965-03
1300	7.70+03	1.0+00	3.16+03	7.59+04	2.3471+00	7.9748+00	3.0455-04	1.0352-03
1310	7.70+03	1.0+00	3.36+03	8.06+04	2.3425+00	7.9593+00	3.0396-04	1.0332-03
1320	7.70+03	1.0+00	3.57+03	8.57+04	2.3380+00	7.9438+00	3.0337-04	1.0312-03
1330	7.70+03	1.0+00	3.79+03	9.10+04	2.3334+00	7.9283+00	3.0277-04	1.0292-03
1340	9.63+03	1.0+00	4.03+03	9.63+04	2.3289+00	7.9129+00	2.4175-04	8.2173-04
1350	9.63+03	1.0+00	4.27+03	1.03+05	2.3244+00	7.8976+00	2.4129-04	8.2013-04
1260	9.63+03	1.0+00	4.54+03	1.09+05	2.3199+00	7.8823+00	2.4082-04	8.1854-04
1370	9.63+03	1.0+00	4.81+03	1.13+05	2.3154+00	7.8570+00	2.4035-04	8.1696-04
1380	1.20+04	1.0+00	5.11+03	1.23+05	2.3109+00	7.8518+00	1.9191-04	6.5230-04
1390	1.20+04	1.0+00	5.41+03	1.30+05	2.3064+00	7.8367+00	1.9151-04	6.5101-04
1400	1.20+04	1.0+00	5.74+03	1.38+05	2.3020+00	7.8216+00	1.9117-04	6.4979-04
1410	1.50+04	1.0+00	6.08+03	1.46+05	2.2976+00	7.8065+00	1.5265-04	5.1883-04
1420	1.50+04	1.0+00	6.45+03	1.55+05	2.2931+00	7.7915+00	1.5235-04	5.1781-04
1430	1.50+04	1.0+00	6.81+03	1.64+05	2.2887+00	7.7765+00	1.5206-04	5.1681-04
1440	1.50+04	1.0+00	7.23+03	1.74+05	2.2843+00	7.7616+00	1.5176-04	5.1585-04
1450	1.88+04	1.0+00	7.66+03	1.84+05	2.2800+00	7.7467+00	1.2118-04	4.1189-04
1460	1.88+04	1.0+00	8.11+03	1.95+05	2.2756+00	7.7319+00	1.2091-04	4.1110-04
1470	1.88+04	1.0+00	8.58+03	2.06+05	2.2713+00	7.7171+00	1.2072-04	4.1031-04
1480	1.88+04	1.0+00	9.08+03	2.18+05	2.2669+00	7.7024+00	1.2049-04	4.0953-04
1490	2.35+04	1.0+00	9.61+03	2.31+05	2.2626+00	7.6877+00	9.6211-05	3.2700-04
1500	2.35+04	1.0+00	1.02+04	2.44+05	2.2583+00	7.6731+00	9.6024-05	3.2638-04

Таблица 8

Параметры циклической коррекции для  $F_0=200-10^{22}$  Вт/м<sup>2</sup>·Гц и номинальной плотности атмосферы

Высота, км	Время существования, сут	Количество полных циклов	Средняя длина цикла		Средние затраты за цикл		Средние затраты за сутки	
			сут	ч	характеристическая скорость, м/с	топлива, кг	характеристическая скорость, м/с	топлива, кг
125	2.00+00	6.3+01	3.21-02	7.69-01	2.9181+00	9.9139+00	9.3341+01	3.1229+02
130	2.00+00	3.7+01	5.30-02	1.27-00	2.9536+00	1.0034+01	5.5127+01	1.8563+02
135	2.00+00	2.4+01	7.88-02	1.89-00	2.9698+00	1.0089+01	3.5837+01	1.2107+02
140	2.00+00	1.7+01	1.11-01	2.66-00	2.9770+00	1.0114+01	2.5401+01	8.5967+01
145	2.00+00	1.2+01	1.49-01	3.59-00	2.9811+00	1.0128+01	1.7932+01	6.0767+01
150	2.00+00	9.0+00	1.96-01	4.71+00	2.9823+00	1.0132+01	1.3444+01	4.5593+01
155	2.00+00	6.0+00	2.53-01	6.06+00	2.9834+00	1.0136+01	8.9592+00	3.0407+01
160	2.00+00	5.0+00	3.20-01	7.67+00	2.9815+00	1.0129+01	7.4593+00	2.5323+01
165	2.00+00	4.0+00	3.99-01	9.57+00	2.9795+00	1.0123+01	5.9621+00	2.0245+01
170	2.00+00	3.0+00	4.91-01	1.18+01	2.9776+00	1.0116+01	4.4676+00	1.5174+01
175	2.00+00	2.0+00	6.00-01	1.44+01	2.9757+00	1.0109+01	2.9757+00	1.0109+01
180	2.00+00	1.0+00	7.15-01	1.72+01	2.9736+00	1.0102+01	1.4834+00	5.0512+00
185	2.00+00	1.0+00	8.44-01	2.03+01	2.9702+00	1.0091+01	1.4847+00	5.0454+00
190	2.00+00	1.0+00	9.89-01	2.37+01	2.9668+00	1.0079+01	1.4830+00	5.0397+00
195	2.50+00	1.0+00	1.15+00	2.76+01	2.9634+00	1.0068+01	1.1850+00	4.0271+00
200	3.12+00	1.0+00	1.33+00	3.20+01	2.9601+00	1.0056+01	9.4690+00	3.2180+00
205	3.12+00	1.0+00	1.54+00	3.69+01	2.9567+00	1.0045+01	9.4582+00	3.2144+00
210	3.91+00	1.0+00	1.77+00	4.24+01	2.9533+00	1.0033+01	7.5577-01	2.5688+00
215	4.88+00	1.0+00	2.02+00	4.85+01	2.9500+00	1.0022+01	6.0391-01	2.0625+00
220	4.88+00	1.0+00	2.30+00	5.52+01	2.9466+00	1.0011+01	6.0323-01	2.0502+00
225	6.10+00	1.0+00	2.61+00	6.27+01	2.9433+00	9.9993+00	4.8202-01	1.6383+00
230	6.10+00	1.0+00	2.96+00	7.09+01	2.9399+00	9.9880+00	4.8148-01	1.6364+00
235	7.63+00	1.0+00	3.34+00	8.00+01	2.9366+00	9.9767+00	3.8474-01	1.3077+00
240	7.63+00	1.0+00	3.75+00	9.01+01	2.9333+00	9.9654+00	3.8430+01	1.3062+00
245	9.54+00	1.0+00	4.21+00	1.01+02	2.9299+00	9.9541+00	3.0709-01	1.0438+00
250	9.54+00	1.0+00	4.72+00	1.13+02	2.9266+00	9.9428+00	3.0674+01	1.0426+00
255	1.19+01	1.0+00	5.27+00	1.27+02	2.9233+00	9.9316+00	2.4511-01	8.3312-01

Продолжение табл. 8

Высота, км	Время существования, сут	Количество полных циклов	Средняя длина цикла		Средние затраты за цикл		Средние затраты за сутки	
			сут	ч	характеристическая скорость, м/с	топлива, кг	характеристическая скорость, м/с	топлива, кг
260	1.19+01	1.0+00	5.88+00	1.41+02	2.9200+00	9.9204+00	2.4481-01	8.3218-01
265	1.49+01	1.0+00	5.54+00	1.57+02	2.9167+00	9.9092+00	1.9565-01	6.6499-01
270	1.49+01	1.0+00	7.26+00	1.74+02	2.9134+00	9.8980+00	1.9543-01	6.6424-01
275	1.85+01	1.0+00	8.05+00	1.93+02	2.9101+00	9.8858+00	1.5616-01	5.3080-01
280	1.85+01	1.0+00	8.91+00	2.14+02	2.9069+00	9.8757+00	1.5599-01	5.3020-01
285	2.33+01	1.0+00	9.85+00	2.36+02	2.9036+00	9.8646+00	1.2465-01	4.2368-01
290	2.33+01	1.0+00	1.03+01	2.61+02	2.9003+00	9.8535+00	1.2451-01	4.2320-01
295	2.91+01	1.0+00	1.20+01	2.87+02	2.8971+00	9.8424+00	9.9495-02	3.3818-01
300	2.91+01	1.0+00	1.32+01	3.16+02	2.8938+00	9.8314+00	9.9383-02	3.3780-01
310	3.64+01	1.0+00	1.59+01	3.81+02	2.8873+00	9.8093+00	7.9328-02	2.6964-01
320	4.55+01	1.0+00	1.90+01	4.57+02	2.8809+00	9.7874+00	6.3390-02	2.1523-01
330	4.55+01	1.0+00	2.27+01	5.45+02	2.8744+00	9.7655+00	6.3179-02	2.1475-01
340	5.68+01	1.0+00	2.70+01	6.48+02	2.8680+00	9.7437+00	5.0430-02	1.7141-01
350	7.11+01	1.0+00	3.20+01	7.67+02	2.8616+00	9.7220+00	4.0954-02	1.3683-01
360	8.88+01	1.0+00	3.77+01	9.05+02	2.8552+00	9.7004+00	3.2132-02	1.0972-01
370	8.88+01	1.0+00	4.43+01	1.06+03	2.8489+00	9.6788+00	3.2060-02	1.0897-01
380	1.11+02	1.0+00	5.19+01	1.25+03	2.8426+00	9.6573+00	2.5591-02	8.6986-02
390	1.39+02	1.0+00	6.06+01	1.45+03	2.8363+00	9.6359+00	2.0428-02	6.9431-02
400	1.39+02	2.2+02	7.06+01	1.69+03	2.8300+00	9.6145+00	3.9802+00	1.3520+01
410	1.39+02	1.8+02	8.20+01	1.97+03	2.8237+00	9.5931+00	3.4172+00	1.1608+01
420	1.39+02	1.6+02	0.49-01	2.28+03	2.8174+00	9.5717+00	2.9437+00	1.0001+01
430	1.39+02	1.3+02	1.10+00	2.63+03	2.8111+00	9.5503+00	2.5214+00	8.6007+00
440	1.39+02	1.1+02	1.26+00	3.03+03	2.8048+00	9.5289+00	2.1845+00	7.4925+00
450	1.39+02	9.8+01	1.45+00	3.49+03	2.7985+00	9.5075+00	1.8880+00	6.4153+00
460	1.39+02	8.5+01	1.67+00	4.00+03	2.7922+00	9.4861+00	1.6440+00	5.5855+00
470	1.39+02	7.4+01	1.91+00	4.59+03	2.7859+00	9.4647+00	1.4256+00	4.8783+00
480	1.39+02	6.4+01	2.18+00	5.24+03	2.7796+00	9.4433+00	1.2447+00	4.2999+00
490	1.39+02	5.6+01	2.49+00	5.98+03	2.7733+00	9.4219+00	1.0998+00	3.7072+00
500	1.39+02	4.9+01	2.84+00	6.81+03	2.7670+00	9.4005+00	9.5556-01	3.2475+00
510	1.39+02	4.2+01	3.23+00	7.74+03	2.7607+00	9.3791+00	8.1996-01	2.7867+00
520	1.39+02	3.7+01	3.66+00	8.79+03	2.7544+00	9.3577+00	7.2247-01	2.4554+00
530	1.39+02	3.2+01	4.15+00	9.98+03	2.7481+00	9.3363+00	6.2495-01	2.1240+00
540	1.39+02	2.8+01	4.69+00	1.13+04	2.7418+00	9.3149+00	5.4667-01	1.8580+00
550	1.39+02	2.5+01	5.20+00	1.27+04	2.7355+00	9.2935+00	4.8773-01	1.6577+00
560	1.39+02	2.2+01	5.78+00	1.44+04	2.7292+00	9.2721+00	4.2887-01	1.4577+00
570	1.39+02	1.9+01	6.74+00	1.62+04	2.7229+00	9.2507+00	3.7011-01	1.2579+00
580	1.39+02	1.7+01	7.58+00	1.83+04	2.7166+00	9.2293+00	3.2074-01	1.1242+00
590	1.39+02	1.5+01	8.52+00	2.04+04	2.7103+00	9.2079+00	2.9148-01	9.9669-01
600	1.39+02	1.3+01	9.56+00	2.29+04	2.7040+00	9.1865+00	2.5230-01	8.5755-01
610	1.39+02	1.3+01	9.66+00	2.32+04	2.6977+00	9.1651+00	2.5176-01	8.5572-01
620	1.39+02	1.2+01	1.07+01	2.58+04	2.6914+00	9.1437+00	2.3201-01	7.8858-01
630	1.39+02	1.0+01	1.18+01	2.83+04	2.6851+00	9.1223+00	1.9310-01	6.5635-01
640	1.39+02	9.0+00	1.30+01	3.12+04	2.6788+00	9.1009+00	1.7350-01	5.8972-01
650	1.39+02	8.0+00	1.43+01	3.44+04	2.6725+00	9.0795+00	1.5390-01	5.2332-01
660	1.39+02	7.0+00	1.58+01	3.79+04	2.6662+00	9.0581+00	1.3440-01	4.5714-01
670	1.39+02	7.0+00	1.74+01	4.17+04	2.6599+00	9.0367+00	1.3421-01	4.5617-01
680	1.39+02	6.0+00	1.91+01	4.59+04	2.6536+00	9.0153+00	1.1484-01	3.9035-01
690	1.39+02	5.0+00	2.10+01	5.04+04	2.6473+00	8.9939+00	9.5542-02	3.2475-01
700	1.39+02	5.0+00	2.31+01	5.54+04	2.6410+00	8.9725+00	9.5340-02	3.2406-01
710	1.39+02	4.0+00	2.54+01	6.09+04	2.6347+00	8.9511+00	7.6145-02	2.5882-01
720	1.39+02	3.0+00	2.79+01	6.68+04	2.6284+00	8.9297+00	5.7013-02	1.9379-01
730	1.39+02	3.0+00	3.06+01	7.33+04	2.6221+00	8.9083+00	5.6893-02	1.9338-01
740	1.39+02	3.0+00	3.35+01	8.04+04	2.6158+00	8.8869+00	5.6773-02	1.9297-01
750	1.39+02	2.0+00	3.67+01	8.81+04	2.6095+00	8.8655+00	3.7785-02	1.2843-01
760	1.39+02	2.0+00	4.02+01	9.66+04	2.6032+00	8.8441+00	3.7706-02	1.2816-01
770	1.39+02	2.0+00	4.40+01	1.06+05	2.5969+00	8.8227+00	3.7627-02	1.2790-01
780	1.39+02	1.0+00	4.82+01	1.16+05	2.5906+00	8.8013+00	1.8781-02	6.3838-02
790	1.39+02	1.0+00	5.27+01	1.27+05	2.5843+00	8.7799+00	1.8742-02	6.3705-02
800	1.39+02	1.0+00	5.76+01	1.38+05	2.5780+00	8.7585+00	1.8703-02	6.3572-02
810	1.39+02	1.0+00	6.30+01	1.51+05	2.5717+00	8.7371+00	1.8664-02	6.3439-02
820	1.39+02	1.0+00	6.89+01	1.65+05	2.5654+00	8.7157+00	1.8625-02	6.3307-02
830	1.73+02	1.0+00	7.51+01	1.80+05	2.5591+00	8.6943+00	1.8586-02	5.0540-02
840	1.73+02	1.0+00	8.19+01	1.97+05	2.5528+00	8.6729+00	1.8547-02	5.0435-02
850	2.17+02	1.0+00	8.93+01	2.14+05	2.5465+00	8.6515+00	1.8508-02	4.0265-02

Высота, км	Время существования, сут	Количество полных циклов	Средняя длина цикла		Средние затраты за цикл		Средние затраты за сутки	
			сут	ч	характеристическая скорость, м/с	топлива, кг	характеристическая скорость, м/с	топлива, кг
860	2.17+02	1.0+00	9.74+01	2.34+03	2.5644+00	8.7129+00	1.1821-02	4.0181-02
870	2.17+02	1.0+00	1.03+02	2.55+03	2.5591+00	8.6949+00	1.1797-02	4.0098-02
880	2.71+02	1.0+00	1.16+02	2.77+03	2.5538+00	8.6769+00	9.4180-03	3.2012-02
890	2.71+02	1.0+00	1.26+02	3.02+03	2.5485+00	8.6590+00	9.3985-03	3.1946-02
900	3.39+02	1.0+00	1.37+02	3.19+03	2.5433+00	8.6412+00	7.5033-03	2.5504-02
910	3.39+02	1.0+00	1.49+02	3.58+03	2.5381+00	8.6234+00	7.4879-03	2.5452-02
920	3.39+02	1.0+00	1.62+02	3.89+03	2.5329+00	8.6057+00	7.4725-03	2.5299-02
930	4.24+02	1.0+00	1.76+02	4.23+03	2.5277+00	8.5880+00	5.9658-03	2.0278-02
940	4.24+02	1.0+00	1.91+02	4.59+03	2.5225+00	8.5704+00	5.9535-03	2.0236-02
950	4.24+02	1.0+00	2.08+02	4.99+03	2.5173+00	8.5529+00	5.9414-03	2.0195-02
960	5.29+02	1.0+00	2.26+02	5.42+03	2.5122+00	8.5354+00	4.7434-03	1.6123-02
970	5.29+02	1.0+00	2.45+02	5.88+03	2.5071+00	8.5180+00	4.7337-03	1.6090-02
980	6.62+02	1.0+00	2.66+02	6.38+03	2.5019+00	8.5006+00	3.7792-03	1.2846-02
990	6.62+02	1.0+00	2.88+02	6.91+03	2.4969+00	8.4833+00	3.7715-03	1.2820-02
1000	6.62+02	1.0+00	3.12+02	7.50+03	2.4918+00	8.4661+00	3.7639-03	1.2794-02
1010	8.27+02	1.0+00	3.38+02	8.12+03	2.4867+00	8.4489+00	3.0050-03	1.0214-02
1020	8.27+02	1.0+00	3.67+02	8.80+03	2.4817+00	8.4318+00	2.9989-03	1.0193-02
1030	8.27+02	1.0+00	3.97+02	9.53+03	2.4767+00	8.4147+00	2.9928-03	1.0173-02
1040	1.03+03	1.0+00	4.30+02	1.03+04	2.4716+00	8.3977+00	2.3894-03	8.1218-03
1050	1.03+03	1.0+00	4.65+02	1.12+04	2.4667+00	8.3808+00	2.3846-03	8.1054-03
1060	1.03+03	1.0+00	5.03+02	1.21+04	2.4617+00	8.3639+00	2.3798-03	8.0890-03
1070	1.29+03	1.0+00	5.44+02	1.31+04	2.4567+00	8.3470+00	1.9000-03	6.4582-03
1080	1.29+03	1.0+00	5.88+02	1.41+04	2.4518+00	8.3303+00	1.8952-03	6.4452-03
1090	1.29+03	1.0+00	6.36+02	1.53+04	2.4469+00	8.3135+00	1.8924-03	6.4323-03
1100	1.62+03	1.0+00	6.87+02	1.65+04	2.4419+00	8.2969+00	1.5109-03	5.1355-03
1110	1.62+03	1.0+00	7.42+02	1.78+04	2.4371+00	8.2803+00	1.5078-03	5.1252-03
1120	1.62+03	1.0+00	8.01+02	1.92+04	2.4322+00	8.2637+00	1.5048-03	5.1150-03
1130	2.02+03	1.0+00	8.65+02	2.07+04	2.4273+00	8.2472+00	1.2015-03	4.0838-03
1140	2.02+03	1.0+00	9.33+02	2.24+04	2.4225+00	8.2307+00	1.1991-03	4.0757-03
1150	2.02+03	1.0+00	1.01+03	2.42+04	2.4177+00	8.2144+00	1.1967-03	4.0676-03
1160	2.52+03	1.0+00	1.09+03	2.60+04	2.4128+00	8.1980+00	9.5543-04	3.2476-03
1170	2.52+03	1.0+00	1.17+03	2.81+04	2.4080+00	8.1817+00	9.5353-04	3.2411-03
1180	2.52+03	1.0+00	1.26+03	3.03+04	2.4033+00	8.1655+00	9.5165-04	3.2347-03
1190	3.16+03	1.0+00	1.36+03	3.26+04	2.3985+00	8.1493+00	7.5981-04	2.5826-03
1200	3.16+03	1.0+00	1.46+03	3.51+04	2.3938+00	8.1332+00	7.5830-04	2.5775-03
1210	3.16+03	1.0+00	1.58+03	3.78+04	2.3890+00	8.1171+00	7.5680-04	2.5724-03
1220	3.94+03	1.0+00	1.70+03	4.07+04	2.3843+00	8.1011+00	6.0425-04	2.0539-03
1230	3.94+03	1.0+00	1.83+03	4.38+04	2.3796+00	8.0851+00	6.0306-04	2.0498-03
1240	3.94+03	1.0+00	1.96+03	4.71+04	2.3749+00	8.0692+00	6.0188-04	2.0458-03
1250	4.93+03	1.0+00	2.11+03	5.07+04	2.3703+00	8.0534+00	4.8055-04	1.6334-03
1260	4.93+03	1.0+00	2.27+03	5.45+04	2.3656+00	8.0376+00	4.7961-04	1.6302-03
1270	4.93+03	1.0+00	2.44+03	5.86+04	2.3610+00	8.0218+00	4.7867-04	1.6270-03
1280	6.16+03	1.0+00	2.63+03	6.30+04	2.3563+00	8.0061+00	3.8219-04	1.2991-03
1290	6.16+03	1.0+00	2.82+03	6.77+04	2.3517+00	7.9904+00	3.8144-04	1.2955-03
1300	6.16+03	1.0+00	3.03+03	7.27+04	2.3471+00	7.9748+00	3.8069-04	1.2940-03
1310	7.70+03	1.0+00	3.25+03	7.81+04	2.3425+00	7.9593+00	3.0396-04	1.0332-03
1320	7.70+03	1.0+00	3.49+03	8.39+04	2.3380+00	7.9438+00	3.0337-04	1.0312-03
1330	7.70+03	1.0+00	3.75+03	9.00+04	2.3334+00	7.9283+00	3.0277-04	1.0292-03
1340	9.63-03	1.0+00	4.03+03	9.66+04	2.3289+00	7.9129+00	2.4175-04	8.2173-04
1350	9.63-03	1.0+00	4.32+03	1.04+05	2.3244+00	7.8976+00	2.4129-04	8.2013-04
1360	9.63-03	1.0+00	4.63+03	1.11+05	2.3199+00	7.8823+00	2.4082-04	8.1854-04
1370	1.20+04	1.0+00	4.97+03	1.19+05	2.3154+00	7.8670+00	1.9228-04	6.5357-04
1380	1.20+04	1.0+00	5.33+03	1.28+05	2.3109+00	7.8518+00	1.9191-04	6.5230-04
1390	1.20+04	1.0+00	5.71+03	1.37+05	2.3064+00	7.8367+00	1.9154-04	6.5104-04
1400	1.50+04	1.0+00	6.12+03	1.47+05	2.3020+00	7.8216+00	1.5294-04	5.1983-04
1410	1.50+04	1.0+00	6.56+03	1.57+05	2.2976+00	7.8065+00	1.5265-04	5.1883-04
1420	1.50+04	1.0+00	7.02+03	1.69+05	2.2931+00	7.7915+00	1.5235-04	5.1783-04
1430	1.50+04	1.0+00	7.52+03	1.81+05	2.2887+00	7.7765+00	1.5206-04	5.1684-04
1440	1.88+04	1.0+00	8.05+03	1.93+05	2.2843+00	7.7616+00	1.2142-04	4.1268-04
1450	1.88+04	1.0+00	8.62+03	2.07+05	2.2800+00	7.7467+00	1.2118-04	4.1189-04
1460	1.88+04	1.0+00	9.23+03	2.21+05	2.2756+00	7.7319+00	1.2094-04	4.1110-04
1470	2.35+04	1.0+00	9.87+03	2.37+05	2.2713+00	7.7171+00	9.6575-05	3.2825-04
1480	2.35+04	1.0+00	1.06+04	2.54+05	2.2669+00	7.7024+00	9.6393-05	3.2762-04
1490	2.35+04	1.0+00	1.13+04	2.71+05	2.2626+00	7.6877+00	9.6211-05	3.2700-04
1500	2.94+04	1.0+00	1.21+04	2.90+05	2.2583+00	7.6731+00	7.6815-05	2.6110-04



Таблица 9

Параметры циклической коррекции для  $F_0=225 \cdot 10^{-22}$  Вт/м<sup>2</sup>·Гц и номинальной плотности атмосферы

Высота, км	Время существования, сут	Количество полных циклов	Средняя длина цикла		Средние затраты эя цикл		Средние затраты за сутки	
			сут	ч	характеристическая скорость, м/с	топлива, кг	характеристическая скорость, м/с	топлива, кг
125	2.00+00	6.3±01	3.20-02	7.69-01	2.9181+00	9.9139+00	9.3341+01	3.1229+02
130	2.00+00	3.7+01	5.27-02	1.27+00	2.9536+00	1.0034-01	5.5127+01	1.8553-02
135	2.00+00	2.4+01	7.79-02	1.87+00	2.9398+00	1.0089+01	3.5837+01	1.2107-02
140	2.00+00	1.7+01	1.09-01	2.61+00	2.9770+00	1.0114+01	2.5401+01	8.5937+01
145	2.00+00	1.2+01	1.46-01	3.51+00	2.9811+00	1.0128+01	1.7932+01	6.0767+01
150	2.00+00	9.0+00	1.91-01	4.58+00	2.9823+00	1.0132+01	1.3444+01	4.5593+01
155	2.00+00	7.0+00	2.44-01	5.87+00	2.9819+00	1.0130+01	1.0450+01	3.5456+01
160	2.00+00	5.0+00	3.08-01	7.38+00	2.9815+00	1.0129+01	7.4593+00	2.5323+01
165	2.00+00	4.0+00	3.82-01	9.17+00	2.9795+00	1.0123+01	5.9621+00	2.0245+01
170	2.00+00	3.0+00	4.69-01	1.13+01	2.9776+00	1.0116+01	4.4676+00	1.5174+01
175	2.00+00	2.0+00	5.70-01	1.37+01	2.9757+00	1.0109+01	2.9757+00	1.0109+01
180	2.00+00	1.0+00	6.73-01	1.62+01	2.9736+00	1.0102+01	1.4854+00	5.0512+00
185	2.00+00	1.0+00	7.92-01	1.90+01	2.9702+00	1.0091+01	1.4847+00	5.0454+00
190	2.00+00	1.0+00	9.24-01	2.22+01	2.9668+00	1.0079+01	1.4830+00	5.0397+00
195	2.50+00	1.0+00	1.07+00	2.57+01	2.9634+00	1.0068+01	1.1850+00	4.0271+00
200	2.50+00	1.0+00	1.24+00	2.97+01	2.9601+00	1.0056+01	1.1837+00	4.0226+00
205	3.12+00	1.0+00	1.42+00	3.41+01	2.9567+00	1.0045+01	9.4582-01	3.2144-00
210	3.91+00	1.0+00	1.63+00	3.90+01	2.9533+00	1.0033+01	7.3577-01	2.5685+00
215	3.91+00	1.0+00	1.85+00	4.44+01	2.9500+00	1.0022+01	7.5491-01	2.5657+00
220	4.88+00	1.0+00	2.10+00	5.04+01	2.9466+00	1.0011+01	6.0323-01	2.0502+00
225	4.88+00	1.0+00	2.38+00	5.70+01	2.9433+00	9.9993+00	6.0254-01	2.0479+00
230	6.10+00	1.0+00	2.68+00	6.43+01	2.9399+00	9.9880+00	4.8148-01	1.6364+00
235	6.10+00	1.0+00	3.01+00	7.22+01	2.9366+00	9.9767+00	4.8093-01	1.6340+00
240	7.63+00	1.0+00	3.37+00	8.09+01	2.9333+00	9.9654+00	3.8430-01	1.3062+00
245	7.63+00	1.0+00	3.77+00	9.05+01	2.9299+00	9.9541+00	3.8387-01	1.3047+00
250	9.54+00	1.0+00	4.20+00	1.01+02	2.9266+00	9.9428+00	3.0674-01	1.0426+00
255	9.54+00	1.0+00	4.68+00	1.12+02	2.9233+00	9.9316+00	3.0640-01	1.0414+00
260	1.19+01	1.0+00	5.19+00	1.25+02	2.9200+00	9.9204+00	2.4484-01	8.3218-01
265	1.19+01	1.0+00	5.76+00	1.38+02	2.9167+00	9.9092+00	2.4456-01	8.3124-01
270	1.49+01	1.0+00	6.37+00	1.53+02	2.9134+00	9.8980+00	1.9543-01	6.6424-01
275	1.49+01	1.0+00	7.03+00	1.69+02	2.9101+00	9.8868+00	1.9521-01	6.6349-01
280	1.86+01	1.0+00	7.75+00	1.86+02	2.9069+00	9.8757+00	1.5599-01	5.3020-01
285	1.86+01	1.0+00	8.53+00	2.05+02	2.9036+00	9.8646+00	1.5581-01	5.2950-01
290	2.33+01	1.0+00	9.37+00	2.25+02	2.9003+00	9.8535+00	1.2451-01	4.2320-01
295	2.33+01	1.0+00	1.03+01	2.47+02	2.8971+00	9.8424+00	1.2437-01	4.2273-01
300	2.33+01	1.0+00	1.13+01	2.70+02	2.8938+00	9.8314+00	1.2423-01	4.2225-01
310	2.91+01	1.0+00	1.35+01	3.23+02	2.8873+00	9.8093+00	9.9160-02	3.3705-01
320	3.64+01	1.0+00	1.60+01	3.85+02	2.8809+00	9.7874+00	7.9151-02	2.6903-01
330	4.55+01	1.0+00	1.90+01	4.56+02	2.8744+00	9.7655+00	6.3179-02	2.1475-01
340	4.55+01	1.0+00	2.24+01	5.38+02	2.8680+00	9.7437+00	6.3038-02	2.1427-01
350	5.68+01	1.0+00	2.63+01	6.32+02	2.8616+00	9.7220+00	5.0318-02	1.7103-01
360	7.11+01	1.0+00	3.09+01	7.40+02	2.8552+00	9.7004+00	4.0165-02	1.3652-01
370	8.88+01	1.0+00	3.60+01	8.64+02	2.8489+00	9.6788+00	3.2060-02	1.0897-01
380	8.88+01	1.0+00	4.19+01	1.01+03	2.8426+00	9.6573+00	3.1989-02	1.0873-01
390	1.11+02	1.0+00	4.86+01	1.17+03	2.8363+00	9.6359+00	2.5535-02	8.6793-02
400	1.11+02	2.2+02	5.62-01	1.35+01	2.5555+00	8.6826+00	4.9970+00	1.6971+01
410	1.11+02	1.9+02	6.48-01	1.55+01	2.5886+00	8.7951+00	4.3148+00	1.4655+01
420	1.11+02	1.6+02	7.46-01	1.79+01	2.6149+00	8.8842+00	3.7455+00	1.2724+01
430	1.11+02	1.4+02	8.56-01	2.05+01	2.6365+00	8.9576+00	3.2537+00	1.1054+01
440	1.11+02	1.2+02	9.80-01	2.35+01	2.6545+00	9.0188+00	2.8214+00	9.5857+00
450	1.11+02	1.0+02	1.12+00	2.69+01	2.6677+00	9.0634+00	2.4748+00	8.4085+00
460	1.11+02	8.9+01	1.28+00	3.07+01	2.6796+00	9.1039+00	2.1479+00	7.2980+00
470	1.11+02	7.8+01	1.45+00	3.49+01	2.6877+00	9.1316+00	1.8880+00	6.4155+00
480	1.11+02	6.8+01	1.65+00	3.96+01	2.6946+00	9.1550+00	1.6501+00	5.6074+00
490	1.11+02	5.9+01	1.87+00	4.49+01	2.7003+00	9.1741+00	1.4347+00	4.8754+00
500	1.11+02	5.2+01	2.12+00	5.09+01	2.7033+00	9.1846+00	1.2659+00	4.3018+00
510	1.11+02	4.6+01	2.40+00	5.75+01	2.7052+00	9.1907+00	1.1205+00	3.8080+00
520	1.11+02	4.0+01	2.70+00	6.49+01	2.7069+00	9.1958+00	9.7499-01	3.3135+00
530	1.11+02	3.6+01	3.04+00	7.31+01	2.7062+00	9.1943+00	8.7724-01	2.9813+00
540	1.11+02	3.1+01	3.42+00	8.22+01	2.7067+00	9.1960+00	7.5552-01	2.5677+00

Высота, к1	Время существования, сут	Количество полных циклов	Средняя длина цикла		Средние затраты за цикл		Средние затраты за сутки	
			сут	ч	характеристическая скорость, м/с	топлива, кг	характеристическая скорость, м/с	топлива, кг
550	1.11+02	2.8+01	3.85+00	9.23+01	2.7047+00	9.1891+00	6.8189-01	2.3175+00
560	1.11+02	2.5+01	4.32+00	1.04+02	2.7027+00	9.1823+00	6.0837-01	2.0577+00
570	1.11+02	2.2+01	4.83+00	1.16+02	2.7006+00	9.1754+00	5.3495-01	1.8182+00
580	1.11+02	1.9+01	5.41+00	1.30+02	2.6986+00	9.1684+00	4.6165-01	1.5591+00
590	1.11+02	1.7+01	6.04+00	1.45+02	2.6953+00	9.1573+00	4.1255-01	1.4322+00
600	1.11+02	1.5+01	6.74+00	1.62+02	2.6920+00	9.1462+00	3.6357-01	1.2357+00
610	1.11+02	1.5+01	6.75+00	1.62+02	2.6853+00	9.1267+00	3.6280-01	1.2331+00
620	1.11+02	1.4+01	7.40+00	1.78+02	2.6818+00	9.1114+03	3.3834-01	1.1490+00
630	1.11+02	1.2+01	8.11+00	1.95+02	2.6785+00	9.1003+00	2.8940-01	9.8362-01
640	1.11+02	1.1+01	8.89+00	2.13+02	2.6741+00	9.0851+00	2.6483-01	9.0015-01
650	1.11+02	1.0+01	9.73+00	2.34+02	2.6696+00	9.0699+00	2.4036-01	8.1695-01
660	1.11+02	9.0+00	1.07+01	2.56+02	2.6651+00	9.0548+00	2.1595-01	7.3403-01
670	1.11+02	8.0+00	1.17+01	2.80+02	2.6607+00	9.0397+00	1.9164-01	6.5138-01
680	1.11+02	7.0+00	1.28+01	3.06+02	2.6562+00	9.0246+00	1.6741-01	5.6900-01
690	1.11+02	6.0+00	1.40+01	3.35+02	2.6518+00	9.0096+00	1.4325-01	4.8391-01
700	1.11+02	6.0+00	1.53+01	3.66+02	2.6462+00	8.9905+00	1.4295-01	4.8588-01
710	1.11+02	5.0+00	1.67+01	4.00+02	2.6418+00	8.9755+00	1.1892-01	4.0422-01
720	1.11+02	5.0+00	1.82+01	4.37+02	2.6362+00	8.9566+00	1.1857-01	4.0337-01
730	1.11+02	4.0+00	1.99+01	4.78+02	2.6318+00	8.9417+00	9.4781-02	3.2215-01
740	1.11+02	4.0+00	2.17+01	5.22+02	2.6263+00	8.9229+00	9.4581-02	3.2148-01
750	1.11+02	3.0+00	2.37+01	5.69+02	2.6219+00	8.9081+00	7.0818-02	2.4071-01
760	1.11+02	3.0+00	2.59+01	6.21+02	2.6164+00	8.8934+00	7.0669-02	2.4020-01
770	1.11+02	2.0+00	2.82+01	6.78+02	2.6120+00	8.8743+00	4.7034-02	1.5987-01
780	1.11+02	2.0+00	3.08+01	7.39+02	2.6066+00	8.8559+00	4.6935-02	1.5953-01
790	1.11+02	2.0+00	3.36+01	8.06+02	2.6011+00	8.8374+00	4.6837-02	1.5920-01
800	1.11+02	2.0+00	3.66+01	8.79+02	2.5957+00	8.8190+00	4.6739-02	1.5887-01
810	1.11+02	1.0+00	3.99+01	9.58+02	2.5913+00	8.8040+00	2.3330-02	7.9299-02
820	1.11+02	1.0+00	4.35+01	1.04+03	2.5859+00	8.7835+00	2.3281-02	7.9134-02
830	1.11+02	1.0+00	4.74+01	1.14+03	2.5805+00	8.7673+00	2.3233-02	7.8969-02
840	1.11+02	1.0+00	5.16+01	1.24+03	2.5751+00	8.7491+00	2.3185-02	7.8805-02
850	1.39+02	1.0+00	5.61+01	1.35+03	2.5698+00	8.7310+00	1.8709-02	6.2913-02
860	1.39+02	1.0+00	6.11+01	1.47+03	2.5644+00	8.7129+00	1.8471-02	6.2783-02
870	1.39+02	1.0+00	6.64+01	1.59+03	2.5591+00	8.6949+00	1.8433-02	6.2653-02
880	1.73+02	1.0+00	7.23+01	1.73+03	2.5538+00	8.6739+00	1.4716-02	5.0019-02
890	1.73+02	1.0+00	7.86+01	1.89+03	2.5483+00	8.6590+00	1.4655-02	4.9916-02
900	1.73+02	1.0+00	8.54+01	2.05+03	2.5433+00	8.6412+00	1.4655-02	4.9813-02
910	2.17+02	1.0+00	9.29+01	2.23+03	2.5381+00	8.6234+00	1.1700-02	3.9768-02
920	2.17+02	1.0+00	1.01+02	2.42+03	2.5329+00	8.6057+00	1.1676-02	3.9687-02
930	2.71+02	1.0+00	1.10+02	2.63+03	2.5277+00	8.5880+00	9.3215-03	3.1684-02
940	2.71+02	1.0+00	1.19+02	2.86+03	2.5225+00	8.5704+00	9.3024-03	3.1619-02
950	2.71+02	1.0+00	1.29+02	3.10+03	2.5173+00	8.5529+00	9.2834-03	3.1555-02
960	3.39+02	1.0+00	1.40+02	3.37+03	2.5122+00	8.5354+00	7.4115-03	2.5192-02
970	3.39+02	1.0+00	1.52+02	3.65+03	2.5071+00	8.5180+00	7.3934-03	2.5141-02
980	3.39+02	1.0+00	1.65+02	3.96+03	2.5019+00	8.5006+00	7.3813-03	2.5089-02
990	4.24+02	1.0+00	1.79+02	4.30+03	2.4969+00	8.4833+00	5.8930-03	2.0031-02
1000	4.24+02	1.0+00	1.94+02	4.66+03	2.4918+00	8.4651+00	5.8811-03	1.9990-02
1010	4.24+02	1.0+00	2.11+02	5.05+03	2.4867+00	8.4489+00	5.8391-03	1.9949-02
1020	5.29+02	1.0+00	2.28+02	5.48+03	2.4817+00	8.4318+00	4.6858-03	1.5927-02
1030	5.29+02	1.0+00	2.47+02	5.94+03	2.4767+00	8.4147+00	4.6763-03	1.5895-02
1040	5.62+02	1.0+00	2.68+02	6.43+03	2.4716+00	8.3977+00	3.7335-03	1.2690-02
1050	6.62+02	1.0+00	2.90+02	6.97+03	2.4667+00	8.3808+00	3.7259-03	1.2665-02
1060	6.62+02	1.0+00	3.14+02	7.54+03	2.4617+00	8.3539+00	3.7184-03	1.2639-02
1070	8.27+02	1.0+00	3.40+02	8.17+03	2.4567+00	8.3470+00	2.9688-03	1.0091-02
1080	8.27+02	1.0+00	3.68+02	8.84+03	2.4518+00	8.3303+00	2.9628-03	1.0071-02
1090	8.27+02	1.0+00	3.99+02	9.57+03	2.4469+00	8.3135+00	2.9568-03	1.0050-02
1100	1.03+03	1.0+00	4.31+02	1.04+04	2.4419+00	8.2969+00	2.3507-03	8.0242-03
1110	1.03+03	1.0+00	4.67+02	1.12+04	2.4371+00	8.2803+00	2.3560-03	8.0082-03
1120	1.03+03	1.0+00	5.05+02	1.21+04	2.4322+00	8.2637+00	2.3513-03	7.9922-03
1130	1.29+03	1.0+00	5.46+02	1.31+04	2.4273+00	8.2472+00	1.8773-03	6.3810-02
1140	1.29+03	1.0+00	5.90+02	1.42+04	2.4225+00	8.2307+00	1.8735-03	6.3682-03



Продолжение табл. 9

Высота, км	Время существования, сут	Количество полных циклов	Средняя длина цикла		Средние затраты за цикл		Средние затраты за сутки	
			сут	ч	характеристическая скорость, м/с	топлива, кг	характеристическая скорость, м/с	топлива, кг
1150	1.29+03	1.0+00	6.38+02	1.53+04	2.4177+00	8.2144+00	1.8698-03	6.3555-03
1160	1.62+03	1.0+00	6.89+02	1.65+04	2.4128+00	8.1980+00	1.4929-03	5.0743-03
1170	1.62+03	1.0+00	7.44+02	1.79+04	2.4080+00	8.1817+00	1.4899-03	5.0642-03
1180	1.62+03	1.0+00	8.04+02	1.93+04	2.4033+00	8.1655+00	1.4859-03	5.0542-03
1190	2.02+03	1.0+00	8.68+02	2.08+04	2.3985+00	8.1493+00	1.1872-03	4.0353-03
1200	2.02+03	1.0+00	9.37+02	2.25+04	2.3938+00	8.1332+00	1.1849-03	4.0274-03
1210	2.52+03	1.0+00	1.01+03	2.43+04	2.390+00	8.1171+00	9.4601-04	3.2155-03
1220	2.52+03	1.0+00	1.09+03	2.62+04	2.3843+00	8.1011+00	9.4414-04	3.2092-03
1230	2.52+03	1.0+00	1.18+03	2.83+04	2.3796+00	8.0851+00	9.4228-04	3.2029-03
1240	3.16+03	1.0+00	1.27+03	3.05+04	2.3749+00	8.0692+00	7.5234-04	2.5572-03
1250	3.16+03	1.0+00	1.37+03	3.29+04	2.3703+00	8.0534+00	7.5086-04	2.5522-03
1260	3.16+03	1.0+00	1.48+03	3.55+04	2.3656+00	8.0376+00	7.4939-04	2.5472-03
1270	3.94+03	1.0+00	1.59+03	3.83+04	2.3610+00	8.0218+00	5.9834-04	2.0338-03
1280	3.94+03	1.0+00	1.72+03	4.13+04	2.3563+00	8.0061+00	5.9717-04	2.0298-03
1290	3.94+03	1.0+00	1.85+03	4.45+04	2.3517+00	7.9904+00	5.9600-04	2.0258-03
1300	4.93+03	1.0+00	2.00+03	4.79+04	2.3471+00	7.9748+00	4.7586-04	1.6175-03
1310	4.93+03	1.0+00	2.15+03	5.16+04	2.3425+00	7.9593+00	4.7494-04	1.6143-03
1320	4.93+03	1.0+00	2.32+03	5.55+04	2.3380+00	7.9438+00	4.7401-04	1.6112-03
1330	6.16+03	1.0+00	2.50+03	5.99+04	2.3334+00	7.9283+00	3.7848-04	1.2864-03
1340	6.16+03	1.0+00	2.69+03	6.45+04	2.3289+00	7.9129+00	3.7774-04	1.2839-03
1350	6.16+03	1.0+00	2.89+03	6.95+04	2.3244+00	7.8976+00	3.7700-04	1.2815-03
1360	7.70+03	1.0+00	3.12+03	7.48+04	2.3199+00	7.8823+00	3.0102-04	1.0232-03
1370	7.70+03	1.0+00	3.35+03	8.05+04	2.3154+00	7.8670+00	3.0044-04	1.0212-03
1380	7.70+03	1.0+00	3.61+03	8.66+04	2.3109+00	7.8518+00	2.9985-04	1.0192-03
1390	9.63+03	1.0+00	3.88+03	9.32+04	2.3064+00	7.8367+00	2.3942-04	8.1381-04
1400	9.63+03	1.0+00	4.18+03	1.00+05	2.3020+00	7.8216+00	2.3896-04	8.1224-04
1410	9.63+03	1.0+00	4.49+03	1.08+05	2.2976+00	7.8065+00	2.3850-04	8.1057-04
1420	1.20+04	1.0+00	4.83+03	1.16+05	2.2931+00	7.7915+00	1.9044-04	6.4729-04
1430	1.20+04	1.0+00	5.19+03	1.25+05	2.2887+00	7.7765+00	1.9007-04	6.4505-04
1440	1.20+04	1.0+00	5.58+03	1.34+05	2.2843+00	7.7616+00	1.8971-04	6.4481-04
1450	1.20+04	1.0+00	6.00+03	1.44+05	2.2800+00	7.7467+00	1.8934-04	6.4357-04
1460	1.50+04	1.0+00	6.45+03	1.55+05	2.2756+00	7.7319+00	1.5119-04	5.1387-04
1470	1.50+04	1.0+00	6.93+03	1.66+05	2.2713+00	7.7171+00	1.5090-04	5.1289-04
1480	1.50+04	1.0+00	7.44+03	1.79+05	2.2669+00	7.7024+00	1.5061-04	5.1191-04
1490	1.88+04	1.0+00	7.99+03	1.92+05	2.2626+00	7.6877+00	1.2026-04	4.0875-04
1500	1.88+04	1.0+00	8.58+03	2.06+05	2.2583+00	7.6731+00	1.2003-04	4.0797-04

Параметры циклической коррекции для  $F_0=250\cdot 10^{-22}$  Вт/м<sup>2</sup>·Гц и номинальной плотности атмосферы

Высота, км	Время существования, сут	Количество полных циклов	Средняя длина цикла		Средние затраты за цикл		Средние затраты за сутки	
			сут	ч	характеристическая скорость, м/с	толщина, кг	характеристическая скорость, м/с	толщина, кг
125	2.00+00	6.3+01	3.19-02	7.66-01	2.9181+00	9.9139+00	9.3341+01	3.1229+02
130	2.00+00	3.8+01	5.22-02	1.25+00	2.9321+00	1.0029+01	5.6502+01	1.9055+02
135	2.00+00	2.5+01	7.68-02	1.84+00	2.9683+00	1.0084+01	3.7320+01	1.2605+02
140	2.00+00	1.7+01	1.07-01	2.55+00	2.9770+00	1.0114+01	2.5401+01	8.5967+01
145	2.00+00	1.3+01	1.43-01	3.43+00	2.9793+00	1.0123+01	1.9422+01	6.5798+01
150	2.00+00	9.0+00	1.86-01	4.45+00	2.9823+00	1.0132+01	1.3444+01	4.5593+01
155	2.00+00	7.0+00	2.37-01	5.69+00	2.9819+00	1.0130+01	1.0450+01	3.5456+01
160	2.00+00	5.0+00	2.98-01	7.15+00	2.9815+00	1.0129+01	7.4593+00	2.5323+01
165	2.00+00	4.0+00	3.69-01	8.85+00	2.9795+00	1.0123+01	5.9621+00	2.0245+01
170	2.00+00	3.0+00	4.51-01	1.06+01	2.9776+00	1.0116+01	4.4676+00	1.5174+01
175	2.00+00	2.0+00	5.47-01	1.31+01	2.9757+00	1.0109+01	2.9757+00	1.0109+01
180	2.00+00	2.0+00	6.47-01	1.55+01	2.9723+00	1.0098+01	2.9723+00	1.0098+01
185	2.00+00	1.0+00	7.61-01	1.83+01	2.9702+00	1.0091+01	1.4847+00	5.0454+00
190	2.00+00	1.0+00	8.88-01	2.13+01	2.9668+00	1.0079+01	1.4830+00	5.0397+00
195	2.50+00	1.0+00	1.03+00	2.47+01	2.9534+00	1.0068+01	1.1850+00	4.0271+00
200	2.50+00	1.0+00	1.19+00	2.85+01	2.9501+00	1.0056+01	1.1837+00	4.0226+00
205	3.12+00	1.0+00	1.36+00	3.26+01	2.9567+00	1.0045+01	9.4582-01	3.2144+00
210	3.12+00	1.0+00	1.55+00	3.72+01	2.9533+00	1.0033+01	9.4474-01	3.2107+00
215	3.91+00	1.0+00	1.76+00	4.23+01	2.9500+00	1.0022+01	7.5491-01	2.5657+00
220	4.88+00	1.0+00	1.99+00	4.78+01	2.9456+00	1.0011+01	6.0323-01	2.0502+00
225	4.88+00	1.0+00	2.24+00	5.39+01	2.9433+00	9.9933+00	6.0254-01	2.0479+00
230	6.10+00	1.0+00	2.52+00	6.05+01	2.9399+00	9.9880+00	4.8148-01	1.6364+00
235	6.10+00	1.0+00	2.82+00	6.77+01	2.9366+00	9.9767+00	4.8093-01	1.6346+00
240	7.63+00	1.0+00	3.15+00	7.55+01	2.9333+00	9.9654+00	3.8430-01	1.3062+00
245	7.63+00	1.0+00	3.51+00	8.42+01	2.9299+00	9.9541+00	3.8387-01	1.3047+00
250	9.54+00	1.0+00	3.90+00	9.35+01	2.9266+00	9.9428+00	3.0674-01	1.0426+00
255	9.54+00	1.0+00	4.32+00	1.04+02	2.9233+00	9.9316+00	3.0640-01	1.0414+00
260	1.19+01	1.0+00	4.78+00	1.15+02	2.9200+00	9.9204+00	2.4484-01	8.3218-01
265	1.19+01	1.0+00	5.27+00	1.27+02	2.9167+00	9.9092+00	2.4456-01	8.3124-01
270	1.19+01	1.0+00	5.81+00	1.39+02	2.9134+00	9.8980+00	2.4428-01	8.3030-01
275	1.49+01	1.0+00	6.39+00	1.53+02	2.9101+00	9.8868+00	1.9521-01	6.6349-01
280	1.49+01	1.0+00	7.01+00	1.68+02	2.9069+00	9.8757+00	1.9499-01	6.6275-01
285	1.85+01	1.0+00	7.68+00	1.84+02	2.9035+00	9.8645+00	1.5581-01	5.2960-01
290	1.85+01	1.0+00	8.41+00	2.02+02	2.9003+00	9.8535+00	1.5564-01	5.2901-01
295	1.85+01	1.0+00	9.19+00	2.21+02	2.8971+00	9.8424+00	1.5546-01	5.2841-01
300	2.33+01	1.0+00	1.00+01	2.41+02	2.8938+00	9.8314+00	1.2423-01	4.2225-01
310	2.91+01	1.0+00	1.19+01	2.85+02	2.8873+00	9.8093+00	9.9160-02	3.3705-01
320	2.91+01	1.0+00	1.40+01	3.37+02	2.8809+00	9.7874+00	9.8939-02	3.3629-01
330	3.64+01	1.0+00	1.65+01	3.96+02	2.8744+00	9.7655+00	7.8974-02	2.6843-01
340	4.55+01	1.0+00	1.93+01	4.63+02	2.8580+00	9.7437+00	6.3038-02	2.1427-01
350	4.55+01	1.0+00	2.25+01	5.40+02	2.8516+00	9.7220+00	6.2897-02	2.1379-01
360	5.68+01	1.0+00	2.62+01	6.28+02	2.8552+00	9.7004+00	5.0206-02	1.7065-01
370	7.11+01	1.0+00	3.03+01	7.27+02	2.8489+00	9.6788+00	4.0075-02	1.3622-01
380	7.11+01	1.0+00	3.50+01	8.39+02	2.8425+00	9.6573+00	3.9986-02	1.3591-01
390	8.88+01	1.0+00	4.02+01	9.65+02	2.8363+00	9.6359+00	3.1918-02	1.0849-01
400	8.88+01	2.1+02	4.62-01	1.11+01	2.5626+00	8.7068+00	6.0916+00	2.0384+01
410	8.88+01	1.8+02	5.28-01	1.27+01	2.5923+00	8.8074+00	5.3144+00	1.8047+01
420	8.88+01	1.6+02	6.03-01	1.45+01	2.6173+00	8.8925+00	4.6282+00	1.5719+01
430	8.88+01	1.4+02	6.88-01	1.65+01	2.6377+00	8.9618+00	4.0399+00	1.3722+01
440	8.88+01	1.2+02	7.82-01	1.88+01	2.6533+00	9.0146+00	3.5555+00	1.2078+01
450	8.88+01	1.0+02	8.87-01	2.13+01	2.6664+00	9.0592+00	3.1224+00	1.0508+01
460	8.88+01	9.1+01	1.00+00	2.41+01	2.6771+00	9.0954+00	2.7429+00	9.3188+00
470	8.88+01	8.0+01	1.13+00	2.72+01	2.6852+00	9.1231+00	2.4185+00	8.2173+00
480	8.88+01	7.0+01	1.28+00	3.07+01	2.6921+00	9.1465+00	2.1215+00	7.2086+00
490	8.88+01	6.2+01	1.44+00	3.46+01	2.6965+00	9.1613+00	1.8820+00	6.3951+00
500	8.88+01	5.5+01	1.62+00	3.89+01	2.6995+00	9.1718+00	1.7114+00	5.6793+00
510	8.88+01	4.9+01	1.82+00	4.36+01	2.7014+00	9.1779+00	1.4900+00	5.0634+00
520	8.88+01	4.3+01	2.04+00	4.89+01	2.7032+00	9.1840+00	1.3084+00	4.4453+00
530	8.88+01	3.8+01	2.28+00	5.47+01	2.7037+00	9.1858+00	1.1564+00	3.9301+00
540	8.88+01	3.4+01	2.54+00	6.11+01	2.7029+00	9.1832+00	1.0344+00	3.5154+00

Продолжение табл. 10

Высота, км	Время существования, сут	Количество полных циклов	Средняя длина цикла		Средние затраты за цикл		Средние затраты на сутки	
			сут	ч	характеристическая скорость, м/с	топлива, кг	характеристическая скорость, м/с	топлива, кг
550	8.88+01	3.0+01	2.84+00	6.81+01	2.7022+00	9.1806+00	9.1244-01	3.1009+00
560	8.88+01	2.7+01	3.16+00	7.59+01	2.7002+00	9.1738+00	8.2057-01	2.7888+00
570	8.88+01	2.4+01	3.52+00	8.45+01	2.6981+00	9.1669+00	7.2883-01	2.4770+00
580	8.88+01	2.1+01	3.91+00	9.39+01	2.6961+00	9.1600+00	6.3724-01	2.1658+00
590	8.88+01	1.9+01	4.34+00	1.04+02	2.6928+00	9.1489+00	5.7585-01	1.9571+00
600	8.88+01	1.7+01	4.82+00	1.16+02	2.6895+00	9.1378+00	5.1460-01	1.7490+00
610	8.88+01	1.7+01	4.72+00	1.13+02	2.6838+00	9.1183+00	5.1350-01	1.7453+00
620	8.88+01	1.6+01	5.17+00	1.24+02	2.6793+00	9.1031+00	4.8249-01	1.6399+00
630	8.88+01	1.4+01	5.66+00	1.35+02	2.6761+00	9.0920+00	4.2166-01	1.4331+00
640	8.88+01	1.3+01	6.19+00	1.49+02	2.6716+00	9.0769+00	3.9089-01	1.3283+00
650	8.88+01	1.2+01	6.78+00	1.63+02	2.6772+00	9.0617+00	3.6021-01	1.2243+00
660	8.88+01	1.1+01	7.41+00	1.78+02	2.6627+00	9.0466+00	3.2954-01	1.1204+00
670	8.88+01	1.0+01	8.11+00	1.95+02	2.6583+00	9.0315+00	2.9917-01	1.0169+00
680	8.88+01	9.0+00	8.86+00	2.13+02	2.6538+00	9.0165+00	2.6881-01	9.1355-01
690	8.88+01	8.0+00	9.69+00	2.33+02	2.6494+00	9.0015+00	2.3854-01	8.1078-01
700	8.88+01	7.0+00	1.03+01	2.54+02	2.6450+00	8.9865+00	2.0837-01	7.0825-01
710	8.88+01	6.0+00	1.16+01	2.78+02	2.6406+00	8.9715+00	1.7831-01	6.0606-01
720	8.88+01	6.0+00	1.26+01	3.03+02	2.6350+00	8.9526+00	1.7793-01	6.0479-01
730	8.88+01	5.0+00	1.38+01	3.31+02	2.6307+00	8.9378+00	1.4803-01	5.0315-01
740	8.88+01	4.0+00	1.51+01	3.62+02	2.6263+00	8.9229+00	1.1823-01	4.0185-01
750	8.88+01	4.0+00	1.65+01	3.95+02	2.6208+00	8.9042+00	1.1798-01	4.0101-01
760	8.88+01	3.0+00	1.80+01	4.31+02	2.6164+00	8.8914+00	8.8336-02	3.0026-01
770	8.88+01	3.0+00	1.93+01	4.70+02	2.6109+00	8.8707+00	8.8151-02	2.9983-01
780	8.88+01	3.0+00	2.14+01	5.13+02	2.6055+00	8.8522+00	8.7967-02	2.9900-01
790	8.88+01	2.0+00	2.33+01	5.59+02	2.6011+00	8.8374+00	5.8547-02	1.9900-01
800	8.88+01	2.0+00	2.54+01	6.10+02	2.5957+00	8.8190+00	5.8424-02	1.9859-01
810	8.88+01	2.0+00	2.77+01	6.65+02	2.5903+00	8.8006+00	5.8302-02	1.9817-01
820	8.88+01	1.0+00	3.02+01	7.25+02	2.5859+00	8.7856+00	2.9102-02	9.8917-02
830	8.88+01	1.0+00	3.29+01	7.90+02	2.5805+00	8.7673+00	2.9041-02	9.8711-02
840	8.88+01	1.0+00	3.58+01	8.60+02	2.5751+00	8.7491+00	2.8981-02	9.8505-02
850	8.88+01	1.0+00	3.90+01	9.37+02	2.5698+00	8.7310+00	2.8921-02	9.8302-02
860	8.88+01	1.0+00	4.25+01	1.02+03	2.5644+00	8.7129+00	2.8861-02	9.8098-02
870	1.11+02	1.0+00	4.63+01	1.11+03	2.5591+00	8.6949+00	2.3041-02	7.8315-02
880	1.11+02	1.0+00	5.04+01	1.21+03	2.5538+00	8.6769+00	2.2993-02	7.8155-02
890	1.11+02	1.0+00	5.48+01	1.32+03	2.5486+00	8.6590+00	2.2946-02	7.7993-02
900	1.39+02	1.0+00	5.95+01	1.43+03	2.5433+00	8.6412+00	1.8319-02	6.2266-02
910	1.39+02	1.0+00	6.49+01	1.56+03	2.5381+00	8.6234+00	1.8281-02	6.2138-02
920	1.73+02	1.0+00	7.05+01	1.69+03	2.5329+00	8.6057+00	1.4595-02	4.9608-02
930	1.73+02	1.0+00	7.67+01	1.84+03	2.5277+00	8.5880+00	1.4555-02	4.9507-02
940	1.73+02	1.0+00	8.34+01	2.00+03	2.5225+00	8.5704+00	1.4535-02	4.9405-02
950	2.17+02	1.0+00	9.06+01	2.17+03	2.5173+00	8.5529+00	1.1604-02	3.9443-02
960	2.17+02	1.0+00	9.85+01	2.36+03	2.5122+00	8.5354+00	1.1580-02	3.9363-02
970	2.17+02	1.0+00	1.07+02	2.57+03	2.5071+00	8.5180+00	1.1557-02	3.9282-02
980	2.71+02	1.0+00	1.16+02	2.79+03	2.5019+00	8.5006+00	9.2267-03	3.1352-02
990	2.71+02	1.0+00	1.26+02	3.03+03	2.4969+00	8.4833+00	9.2079-03	3.1298-02
1000	3.39+02	1.0+00	1.37+02	3.29+03	2.4918+00	8.4661+00	7.3513-03	2.4988-02
1010	3.39+02	1.0+00	1.49+02	3.57+03	2.4867+00	8.4489+00	7.3364-03	2.4937-02
1020	3.39+02	1.0+00	1.61+02	3.87+03	2.4817+00	8.4318+00	7.3215-03	2.4886-02
1030	4.24+02	1.0+00	1.75+02	4.20+03	2.4767+00	8.4147+00	5.8454-03	1.9869-02
1040	4.24+02	1.0+00	1.90+02	4.56+03	2.4716+00	8.3977+00	5.8336-03	1.9829-02
1050	4.24+02	1.0+00	2.06+02	4.95+03	2.4667+00	8.3808+00	5.8218-03	1.9789-02
1060	5.29+02	1.0+00	2.24+02	5.33+03	2.4617+00	8.3639+00	4.6480-03	1.5790-02
1070	5.29+02	1.0+00	2.42+02	5.82+03	2.4567+00	8.3470+00	4.6387-03	1.5767-02
1080	5.29+02	1.0+00	2.63+02	6.31+03	2.4518+00	8.3303+00	4.6294-03	1.5735-02
1090	6.62+02	1.0+00	2.85+02	6.83+03	2.4469+00	8.3135+00	3.6961-03	1.2533-02
1100	6.62+02	1.0+00	3.09+02	7.41+03	2.4419+00	8.2969+00	3.6886-03	1.2538-02
1110	8.27+02	1.0+00	3.34+02	8.03+03	2.4371+00	8.2803+00	2.9450-03	1.0010-02
1120	8.27+02	1.0+00	3.62+02	8.69+03	2.4322+00	8.2637+00	2.9391-03	9.9902-03
1130	8.27+02	1.0+00	3.92+02	9.42+03	2.4273+00	8.2472+00	2.9332-03	9.9702-03
1140	1.03+03	1.0+00	4.25+02	1.02+04	2.4225+00	8.2307+00	2.3419-03	7.9603-03

Высота, км	Время существования, сут	Количество полных циклов	Средняя длина цикла		Средние затраты за цикл		Средние затраты за сутки	
			сут	ч	характеристическая скорость, м/с	топлива, кг	характеристическая скорость, м/с	топлива, кг
1150	1.03+03	1.0+00	4.60+02	1.10+04	2.4177+00	8.2144+00	2.3373-03	7.9444-03
1160	1.03+03	1.0+00	4.98+02	1.20+04	2.4128+00	8.1980+00	2.3326-03	7.9286-03
1170	1.29+03	1.0+00	5.39+02	1.29+04	2.4080+00	8.1817+00	1.8624-03	6.3303-03
1180	1.29+03	1.0+00	5.83+02	1.40+04	2.4033+00	8.1655+00	1.8587-03	6.3177-03
1190	1.29+03	1.0+00	6.31+02	1.51+04	2.3985+00	8.1493+00	1.8550-03	6.3052-03
1200	1.62+03	1.0+00	6.83+02	1.64+04	2.3938+00	8.1332+00	1.4811-03	5.0342-03
1210	1.62+03	1.0+00	7.38+02	1.77+04	2.3890+00	8.1171+00	1.4781-03	5.0243-03
1220	1.62+03	1.0+00	7.99+02	1.92+04	2.3843+00	8.1011+00	1.4752-03	5.0143-03
1230	2.02+03	1.0+00	8.63+02	2.07+04	2.3795+00	8.0851+00	1.1779-03	4.0036-03
1240	2.02+03	1.0+00	9.33+02	2.24+04	2.3749+00	8.0692+00	1.1755-03	3.9957-03
1250	2.02-03	1.0+00	1.01+03	2.42+04	2.3703+00	8.0534+00	1.1732-03	3.9878-03
1260	2.52+03	1.0+00	1.00+03	2.62+04	2.3656+00	8.0376+00	9.3574-04	3.1840-03
1270	2.52+03	1.0+00	1.18+03	2.83+04	2.3510+00	8.0218+00	9.3490-04	3.1778-03
1280	3.16+03	1.0+00	1.27+03	3.05+04	2.3563+00	8.0061+00	7.4645-04	2.5372-03
1290	3.16+03	1.0+00	1.37+03	3.30+04	2.3517+00	7.9904+00	7.4500-04	2.5323-03
1300	3.16+03	1.0+00	1.43+03	3.56+04	2.3471+00	7.9748+00	7.4354-04	2.5273-03
1310	3.94+03	1.0+00	1.60+03	3.85+04	2.3425+00	7.9593+00	5.9367-04	2.0179-03
1320	3.94+03	1.0+00	1.73+03	4.15+04	2.3380+00	7.9438+00	5.9251-04	2.0140-03
1330	3.94+03	1.0+00	1.87+03	4.48+04	2.3334+00	7.9283+00	5.9136-04	2.0101-03
1340	4.93+03	1.0+00	2.02+03	4.84+04	2.3289+00	7.9129+00	4.7217-04	1.6049-03
1350	4.93+03	1.0+00	2.18+03	5.22+04	2.3244+00	7.8976+00	4.7126-04	1.6018-03
1360	4.93+03	1.0+00	2.35+03	5.64+04	2.3199+00	7.8823+00	4.7034-04	1.5987-03
1370	6.16+03	1.0+00	2.53+03	6.08+04	2.3154+00	7.8670+00	3.7555-04	1.2765-03
1380	6.16+03	1.0+00	2.73+03	6.56+04	2.3109+00	7.8518+00	3.7482-04	1.2740-03
1390	6.16+03	1.0+00	2.95+03	7.07+04	2.3064+00	7.8367+00	3.7410-04	1.2716-03
1400	7.70+03	1.0+00	3.18+03	7.63+04	2.3020+00	7.8216+00	2.9870-04	1.0153-03
1410	7.70+03	1.0+00	3.43+03	8.22+04	2.2976+00	7.8065+00	2.9812-04	1.0133-03
1420	7.70+03	1.0+00	3.69+03	8.86+04	2.2931+00	7.7915+00	2.9755-04	1.0114-03
1430	9.63+03	1.0+00	3.98+03	9.55+04	2.2887+00	7.7765+00	2.3758-04	8.0756-04
1440	9.63+03	1.0+00	4.29+03	1.03+05	2.2843+00	7.7616+00	2.3713-04	8.0601-04
1450	9.63+03	1.0+00	4.62+03	1.11+05	2.2800+00	7.7467+00	2.3667-04	8.0447-04
1460	1.20+04	1.0+00	4.98+03	1.20+05	2.2756+00	7.7319+00	1.8898-04	6.4234-04
1470	1.20+04	1.0+00	5.36+03	1.29+05	2.2713+00	7.7171+00	1.8852-04	6.4112-04
1480	1.20+04	1.0+00	5.78+03	1.39+05	2.2669+00	7.7024+00	1.8825-04	6.3989-04
1490	1.50+04	1.0+00	6.22+03	1.49+05	2.2626+00	7.6877+00	1.5032-04	5.1094-04
1500	1.50+04	1.0+00	6.70+03	1.61+05	2.2583+00	7.6731+00	1.5003-04	5.0997-04

Параметры циклической коррекции для  $F_0=275\cdot 10^{-22}$  Вт/м<sup>2</sup>·Гц и номинальной плотности атмосферы

Высота, км	Время существования, сут	Количество полных циклов	Средняя длина цикла		Средние затраты за цикл		Средние затраты за сутки	
			сут	ч	характеристическая скорость, м/с	топлива, кг	характеристическая скорость, м/с	топлива, кг
125	2.00+00	6.3+01	3.19-02	7.65-01	2.9181+00	9.9139+00	9.3341+01	3.1229+02
130	2.00+00	3.8+01	5.20-02	1.25+00	2.9521+00	1.0929+01	5.6602+01	1.9055+02
135	2.00+00	2.5+01	7.62-02	1.83+00	2.9683+00	1.0084+01	3.7320+01	1.2605+02
140	2.00+00	1.8+01	1.05-01	2.53+00	2.9754+00	1.0109+01	2.6888+01	9.0977+01
145	2.00+00	1.3+01	1.41-01	3.37+00	2.9796+00	1.0123+01	1.9422+01	6.5798+01
150	2.00+00	1.0+01	1.82-01	4.38+00	2.9807+00	1.0127+01	1.4934+01	5.0633+01
155	2.00+00	7.0+00	2.32-01	5.57+00	2.9819+00	1.0130+01	1.0450+01	3.5456+01
160	2.00+00	5.0+00	2.90-01	6.95+00	2.9815+00	1.0129+01	7.4593+00	2.5323+01
165	2.00+00	4.0+00	3.58-01	8.60+00	2.9795+00	1.0123+01	5.9621+00	2.0245+01
170	2.00+00	3.0+00	4.37-01	1.05+01	2.9776+00	1.0116+01	4.4676+00	1.5174+01
175	2.00+00	2.0+00	5.29-01	1.27+01	2.9757+00	1.0109+01	2.9757+00	1.0109+01
180	2.00+00	2.0+00	6.22-01	1.49+01	2.9723+00	1.0098+01	2.9723+00	1.0098+01
185	2.00+00	1.0+00	7.30-01	1.75+01	2.9702+00	1.0091+01	1.4847+00	5.0454+00
190	2.00+00	1.0+00	8.50-01	2.04+01	2.9668+00	1.0079+01	1.4830+00	5.0397+00
195	2.00+00	1.0+00	9.82-01	2.36+01	2.9334+00	1.0068+01	1.4814+00	5.0339+00
200	2.50+00	1.0+00	1.13+00	2.71+01	2.9301+00	1.0056+01	1.1837+00	4.0226+00
205	3.12+00	1.0+00	1.29+00	3.09+01	2.9567+00	1.0045+01	9.4582-01	3.2144+00
210	3.12+00	1.0+00	1.46+00	3.52+01	2.9533+00	1.0033+01	9.4474-01	3.2107+00
215	3.91+00	1.0+00	1.65+00	3.98+01	2.9500+00	1.0022+01	7.5491-01	2.5657+00
220	3.91+00	1.0+00	1.87+00	4.49+01	2.9466+00	1.0011+01	7.5405-01	2.5527+00
225	4.88+00	1.0+00	2.10+00	5.04+01	2.9433+00	9.9993+00	6.0251-01	2.0479+00
230	4.88+00	1.0+00	2.35+00	5.64+01	2.9399+00	9.9880+00	6.0186-01	2.0455+00
235	6.10+00	1.0+00	2.62+00	6.29+01	2.9366+00	9.9767+00	4.8093-01	1.6346+00
240	6.10+00	1.0+00	2.92+00	7.01+01	2.9333+00	9.9654+00	4.8039-01	1.6327+00
245	7.63+00	1.0+00	3.24+00	7.78+01	2.9299+00	9.9541+00	3.8387-01	1.3047+00
250	7.63+00	1.0+00	3.59+00	8.61+01	2.9266+00	9.9428+00	3.8343-01	1.3032+00
255	9.54+00	1.0+00	3.96+00	9.51+01	2.9233+00	9.9316+00	3.0640-01	1.0414+00
260	9.54+00	1.0+00	4.37+00	1.05+02	2.9200+00	9.9204+00	3.0605-01	1.0402+00
265	1.19+01	1.0+00	4.81+00	1.15+02	2.9167+00	9.9092+00	2.4456-01	8.3124-01
270	1.19+01	1.0+00	5.28+00	1.27+02	2.9134+00	9.8980+00	2.4428-01	8.3030-01
275	1.19+01	1.0+00	5.79+00	1.39+02	2.9101+00	9.8868+00	2.4401-01	8.2937-01
280	1.49+01	1.0+00	6.34+00	1.52+02	2.9069+00	9.8757+00	1.9499-01	6.6275-01
285	1.49+01	1.0+00	6.92+00	1.66+02	2.9036+00	9.8646+00	1.9477-01	6.6200-01
290	1.86+01	1.0+00	7.55+00	1.81+02	2.9003+00	9.8535+00	1.5564-01	5.2901-01
295	1.85+01	1.0+00	8.23+00	1.98+02	2.8971+00	9.8424+00	1.5546-01	5.2841-01
300	1.85+01	1.0+00	8.96+00	2.15+02	2.8938+00	9.8314+00	1.5529-01	5.2782-01
310	2.33+01	1.0+00	1.05+01	2.53+02	2.8873+00	9.8093+00	1.2395-01	4.2131-01
320	2.91+01	1.0+00	1.24+01	2.98+02	2.8809+00	9.7874+00	9.8939-02	3.3629-01
330	2.91+01	1.0+00	1.45+01	3.48+02	2.8744+00	9.7655+00	9.8717-02	3.3554-01
340	3.64+01	1.0+00	1.69+01	4.05+02	2.8580+00	9.7437+00	7.8797-02	2.6783-01
350	4.55+01	1.0+00	1.96+01	4.69+02	2.8516+00	9.7220+00	6.2897-02	2.1379-01
360	4.55+01	1.0+00	2.26+01	5.42+02	2.8552+00	9.7004+00	6.2757-02	2.1331-01
370	5.68+01	1.0+00	2.60+01	6.25+02	2.8489+00	9.6788+00	5.0094-02	1.7027-01
380	7.11+01	1.0+00	2.99+01	7.17+02	2.8426+00	9.6573+00	3.9986-02	1.3591-01
390	7.11+01	1.0+00	3.42+01	8.21+02	2.8363+00	9.6359+00	3.9898-02	1.3551-01
400	7.11+01	2.0+02	3.91+01	9.38+00	2.8299+00	9.6146+00	7.1901+00	2.4410+01
410	7.11+01	1.7+02	4.45+01	1.07+01	2.8236+00	9.5934+00	6.3084+00	2.1419+01
420	7.11+01	1.5+02	5.06+01	1.21+01	2.8172+00	9.5720+00	5.5118+00	1.8717+01
430	7.11+01	1.3+02	5.74+01	1.38+01	2.8109+00	9.5507+00	4.8413+00	1.6442+01
440	7.11+01	1.1+02	6.49+01	1.56+01	2.8046+00	9.5294+00	4.2681+00	1.4497+01
450	7.11+01	1.0+02	7.33+01	1.76+01	2.6714+00	9.0762+00	3.7604+00	1.2774+01
460	7.11+01	8.8+01	8.26+01	1.98+01	2.6808+00	9.1081+00	3.3205+00	1.1280+01
470	7.11+01	7.8+01	9.29+01	2.23+01	2.6877+00	9.1316+00	2.9506+00	1.0024+01
480	7.11+01	6.9+01	1.04+00	2.50+01	2.6934+00	9.1507+00	2.6155+00	8.8862+00
490	7.11+01	6.1+01	1.17+00	2.81+01	2.6977+00	9.1656+00	2.3159+00	7.8686+00
500	7.11+01	5.4+01	1.31+00	3.14+01	2.7008+00	9.1760+00	2.0524+00	6.9736+00
510	7.11+01	4.8+01	1.46+00	3.51+01	2.7026+00	9.1822+00	1.8255+00	6.2029+00
520	7.11+01	4.3+01	1.63+00	3.91+01	2.7032+00	9.1840+00	1.6356+00	5.5579+00
530	7.11+01	3.8+01	1.82+00	4.36+01	2.7037+00	9.1858+00	1.4456+00	4.9126+00
540	7.11+01	3.4+01	2.02+00	4.85+01	2.7029+00	9.1832+00	1.2931+00	4.3942+00



Высота, км	Время существования, сут	Количество полных циклов	Средняя длина цикла		Средние затраты за цикл		Средние затраты за сутки	
			сут	ч	характеристическая скорость, м/с	топлива, кг	характеристическая скорость, м/с	топлива, кг
550	7.11+01	3.1+01	2.25+00	5.39+01	2.7009+00	9.1764+00	1.1781+00	4.0035+00
560	7.11+01	2.7+01	2.49+00	5.98+01	2.7002+00	9.1738+00	1.0257+00	3.4860+00
570	7.11+01	2.5+01	2.76+00	6.63+01	2.6969+00	9.1627+00	9.4860-01	3.2238+00
580	7.11+01	2.2+01	3.06+00	7.34+01	2.6949+00	9.1558+00	8.3413-01	2.8348+00
590	7.11+01	2.0+01	3.38+00	8.12+01	2.6916+00	9.1447+00	7.5737-01	2.5740+00
600	7.11+01	1.8+01	3.74+00	8.96+01	2.6883+00	9.1336+00	6.8079-01	2.3138+00
610	7.11+01	1.9+01	3.42+00	8.22+01	2.6814+00	9.1100+00	7.1676-01	2.4360+00
620	7.11+01	1.8+01	3.74+00	8.97+01	2.6769+00	9.0948+00	6.7790-01	2.3040+00
630	7.11+01	1.6+01	4.08+00	9.80+01	2.6736+00	9.0837+00	6.0184-01	2.0455+00
640	7.11+01	1.5+01	4.46+00	1.07+02	2.6692+00	9.0685+00	5.6328-01	1.9144+00
650	7.11+01	1.3+01	4.86+00	1.17+02	2.6659+00	9.0576+00	4.8758-01	1.6572+00
660	7.11+01	1.2+01	5.31+00	1.27+02	2.6615+00	9.0425+00	4.4932-01	1.5271+00
670	7.11+01	1.1+01	5.79+00	1.39+02	2.6571+00	9.0274+00	4.1119-01	1.3975+00
680	7.11+01	1.0+01	6.32+00	1.52+02	2.6526+00	9.0124+00	3.7318-01	1.2684+00
690	7.11+01	9.0+00	6.89+00	1.65+02	2.6482+00	8.9974+00	3.3530-01	1.1396+00
700	7.11+01	8.0+00	7.52+00	1.80+02	2.6438+00	8.9825+00	2.9755-01	1.0113+00
710	7.11+01	7.0+00	8.20+00	1.97+02	2.6394+00	8.9675+00	2.5992-01	8.8345-01
720	7.11+01	6.0+00	8.94+00	2.14+02	2.6350+00	8.9526+00	2.2242-01	7.5298-01
730	7.11+01	6.0+00	9.74+00	2.34+02	2.6295+00	8.9338+00	2.2195-01	7.5439-01
740	7.11+01	5.0+00	1.06+01	2.55+02	2.6251+00	8.9190+00	1.8465-01	6.2762-01
750	7.11+01	5.0+00	1.16+01	2.78+02	2.6196+00	8.9002+00	1.8426-01	6.2630-01
760	7.11+01	4.0+00	1.26+01	3.03+02	2.6153+00	8.8855+00	1.4716-01	5.0021-01
770	7.11+01	4.0+00	1.37+01	3.30+02	2.6098+00	8.8659+00	1.4686-01	4.9915-01
780	7.11+01	3.0+00	1.50+01	3.59+02	2.6055+00	8.8522+00	1.0996-01	3.7375-01
790	7.11+01	3.0+00	1.63+01	3.91+02	2.6000+00	8.8337+00	1.0973-01	3.7297-01
800	7.11+01	3.0+00	1.77+01	4.26+02	2.5946+00	8.8152+00	1.0950-01	3.7219-01
810	7.11+01	2.0+00	1.93+01	4.63+02	2.5903+00	8.8006+00	7.2878-02	2.4771-01
820	7.11+01	2.0+00	2.10+01	5.05+02	2.5849+00	8.7823+00	7.2727-02	2.4720-01
830	7.11+01	2.0+00	2.29+01	5.49+02	2.5795+00	8.7640+00	7.2575-02	2.4668-01
840	7.11+01	1.0+00	2.49+01	5.98+02	2.5751+00	8.7491+00	3.6226-02	1.2313-01
850	7.11+01	1.0+00	2.71+01	6.50+02	2.5698+00	8.7310+00	3.6151-02	1.2288-01
860	7.11+01	1.0+00	2.95+01	7.07+02	2.5644+00	8.7129+00	3.6076-02	1.2262-01
870	7.11+01	1.0+00	3.21+01	7.69+02	2.5591+00	8.6949+00	3.6001-02	1.2237-01
880	7.11+01	1.0+00	3.49+01	8.37+02	2.5538+00	8.6739+00	3.5927-02	1.2212-01
890	8.88-01	1.0+00	3.79+01	9.10+02	2.5486+00	8.6590+00	2.8682-02	9.7492-02
900	8.88+01	1.0+00	4.12+01	9.89+02	2.5433+00	8.6412+00	2.8623-02	9.7291-02
910	1.11+02	1.0+00	4.48+01	1.08+03	2.5381+00	8.6234+00	2.2851-02	7.7673-02
920	1.11+02	1.0+00	4.87+01	1.17+03	2.5329+00	8.6057+00	2.2804-02	7.7513-02
930	1.11+02	1.0+00	5.29+01	1.27+03	2.5277+00	8.5880+00	2.2758-02	7.7354-02
940	1.39+02	1.0+00	5.75+01	1.38+03	2.5225+00	8.5704+00	1.8169-02	6.1756-02
950	1.39+02	1.0+00	6.25+01	1.50+03	2.5173+00	8.5529+00	1.8132-02	6.1630-02
960	1.39+02	1.0+00	6.79+01	1.63+03	2.5122+00	8.5354+00	1.8095-02	6.1504-02
970	1.73+02	1.0+00	7.37+01	1.77+03	2.5071+00	8.5180+00	1.4446-02	4.9103-02
980	1.73+02	1.0+00	8.01+01	1.92+03	2.5019+00	8.5006+00	1.4417-02	4.9003-02
990	2.17+02	1.0+00	8.70+01	2.09+03	2.4969+00	8.4833+00	1.1510-02	3.9123-02
1000	2.17+02	1.0+00	9.44+01	2.27+03	2.4918+00	8.4661+00	1.1486-02	3.9043-02
1010	2.17+02	1.0+00	1.03+02	2.46+03	2.4867+00	8.4489+00	1.1463-02	3.8964-02
1020	2.71+02	1.0+00	1.11+02	2.67+03	2.4817+00	8.4318+00	9.1519-03	3.1108-02
1030	2.71+02	1.0+00	1.21+02	2.90+03	2.4767+00	8.4147+00	9.1334-03	3.1045-02
1040	2.71+02	1.0+00	1.31+02	3.14+03	2.4716+00	8.3977+00	9.1149-03	3.0982-02
1050	3.39+02	1.0+00	1.42+02	3.41+03	2.4667+00	8.3808+00	7.2772-03	2.4736-02
1060	3.39+02	1.0+00	1.54+02	3.70+03	2.4617+00	8.3639+00	7.2626-03	2.4686-02
1070	3.39+02	1.0+00	1.67+02	4.02+03	2.4567+00	8.3470+00	7.2480-03	2.4636-02
1080	4.24+02	1.0+00	1.81+02	4.35+03	2.4518+00	8.3303+00	5.7857-03	1.9669-02
1090	4.24+02	1.0+00	1.97+02	4.72+03	2.4469+00	8.3135+00	5.7751-03	1.9630-02
1100	5.29+02	1.0+00	2.13+02	5.12+03	2.4419+00	8.2939+00	4.6108-03	1.5672-02
1110	5.29+02	1.0+00	2.31+02	5.55+03	2.4371+00	8.2803+00	4.6016-03	1.5641-02
1120	5.29+02	1.0+00	2.51+02	6.02+03	2.4322+00	8.2637+00	4.5924-03	1.5610-02
1130	6.62+02	1.0+00	2.72+02	6.52+03	2.4273+00	8.2472+00	3.6666-03	1.2463-02
1140	6.62+02	1.0+00	2.95+02	7.07+03	2.4225+00	8.2307+00	3.6592-03	1.2438-02



Продолжение табл. 11

Высота, км	Время существования, сут	Количество полных циклов	Средние данные цикла		Средние затраты за цикл		Средние затраты за сутки	
			сут	ч	характеристическая скорость, м/с	топлива, кг	характеристическая скорость, м/с	топлива, кг
1150	6.62+02	1.0+00	3.19+02	7.66+03	2.4177+00	8.2144+00	3.6520-03	1.2413-02
1160	8.27+02	1.0+00	3.46+02	8.30+03	2.4128+00	8.1990+00	2.9158-03	9.9108-03
1170	8.27+02	1.0+00	3.75+02	8.99+03	2.4080+00	8.1817+00	2.9100-03	9.8911-03
1180	8.27+02	1.0+00	4.06+02	9.74+03	2.4033+00	8.1655+00	2.9042-03	9.8715-03
1190	1.03+03	1.0+00	4.39+02	1.05+04	2.3985+00	8.1493+00	2.3187-03	7.8815-03
1200	1.03+03	1.0+00	4.76+02	1.14+04	2.3938+00	8.1332+00	2.3142-03	7.8659-03
1210	1.03+03	1.0+00	5.15+02	1.24+04	2.3890+00	8.1171+00	2.3096-03	7.8504-03
1220	1.29+03	1.0+00	5.58+02	1.34+04	2.3843+00	8.1011+00	1.8440-03	6.2679-03
1230	1.29+03	1.0+00	6.04+02	1.45+04	2.3795+00	8.0851+00	1.8404-03	6.2556-03
1240	1.62+03	1.0+00	6.53+02	1.57+04	2.3749+00	8.0692+00	1.4694-03	4.9946-03
1250	1.62+03	1.0+00	7.07+02	1.70+04	2.3703+00	8.0534+00	1.4665-03	4.9848-03
1260	1.62+03	1.0+00	7.65+02	1.84+04	2.3656+00	8.0376+00	1.4636-03	4.9750-03
1270	2.02+03	1.0+00	8.28+02	1.99+04	2.3610+00	8.0218+00	1.1686-03	3.9722-03
1280	2.02+03	1.0+00	8.96+02	2.15+04	2.3563+00	8.0061+00	1.1663-03	3.9644-03
1290	2.02+03	1.0+00	9.69+02	2.33+04	2.3517+00	7.9904+00	1.1641-03	3.9567-03
1300	2.52+03	1.0+00	1.05+03	2.52+04	2.3471+00	7.9748+00	9.2943-04	3.1592-03
1310	2.52+03	1.0+00	1.13+03	2.72+04	2.3425+00	7.9593+00	9.2761-04	3.1530-03
1320	2.52+03	1.0+00	1.23+03	2.94+04	2.3380+00	7.9438+00	9.2580-04	3.1469-03
1330	3.16+03	1.0+00	1.32+03	3.18+04	2.3334+00	7.9283+00	7.3920-04	2.5126-03
1340	3.16+03	1.0+00	1.43+03	3.44+04	2.3289+00	7.9129+00	7.3777-04	2.5077-03
1350	3.16+03	1.0+00	1.55+03	3.72+04	2.3244+00	7.8976+00	7.3634-04	2.5028-03
1360	3.94+03	1.0+00	1.67+03	4.02+04	2.3199+00	7.8823+00	5.8793-04	1.9984-03
1370	3.94+03	1.0+00	1.81+03	4.34+04	2.3154+00	7.8670+00	5.8679-04	1.9945-03
1380	3.94+03	1.0+00	1.95+03	4.69+04	2.3109+00	7.8518+00	5.8565-04	1.9907-03
1390	4.93+03	1.0+00	2.11+03	5.07+04	2.3064+00	7.8367+00	4.6762-04	1.5895-03
1400	4.93+03	1.0+00	2.28+03	5.47+04	2.3020+00	7.8216+00	4.6672-04	1.5864-03
1410	4.93+03	1.0+00	2.45+03	5.91+04	2.2976+00	7.8015+00	4.6582-04	1.5833-03
1420	6.16+03	1.0+00	2.66+03	6.39+04	2.2931+00	7.7915+00	3.7194-04	1.2642-03
1430	6.16+03	1.0+00	2.87+03	6.90+04	2.2887+00	7.7765+00	3.7123-04	1.2618-03
1440	7.70+03	1.0+00	3.10+03	7.45+04	2.2843+00	7.7616+00	2.9541-04	1.0075-03
1450	7.70+03	1.0+00	3.35+03	8.04+04	2.2800+00	7.7467+00	2.9584-04	1.0056-03
1460	7.70+03	1.0+00	3.62+03	8.68+04	2.2756+00	7.7319+00	2.9528-04	1.0037-03
1470	9.63+03	1.0+00	3.90+03	9.37+04	2.2713+00	7.7171+00	2.3577-04	8.0139-04
1480	9.63+03	1.0+00	4.21+03	1.01+05	2.2669+00	7.7024+00	2.3533-04	7.9987-04
1490	9.63+03	1.0+00	4.55+03	1.09+05	2.2626+00	7.6877+00	2.3488-04	7.9834-04
1500	1.20+04	1.0+00	4.91+03	1.18+05	2.2583+00	7.6731+00	1.8754-04	6.3746-04

Примечания к табл. 2—11:

1. Цифра после буквы в обозначении единицы физической величины является показателем степени.

2. Число со знаком, стоящее после значения параметра, является показателем степени десяти — множителя данного значения параметра.

3. Номинальная плотность атмосферы принята по ГОСТ 25645.101—83.

Редактор *Р. С. Федорова*  
Технический редактор *Н. В. Келейникова*  
Корректор *В. Ф. Малютина*

Сдано в наб. 26.03.84 Подп. в печ. 19.09.84 18,3 усл. п. л. 18,75 усл. кр.-отт. 24,35 уч.-изд. л.  
Тираж 10000 Цена 1р.30 коп.

Орден «Знак Почета» Издательство стандартов, 123557, Москва, Новопресненский пер., 3.  
Колужская типография стандартов, ул. Московская, 256. Зак. 1163